

2017 MAINTENANCE SECTION REFERENCE BOOK

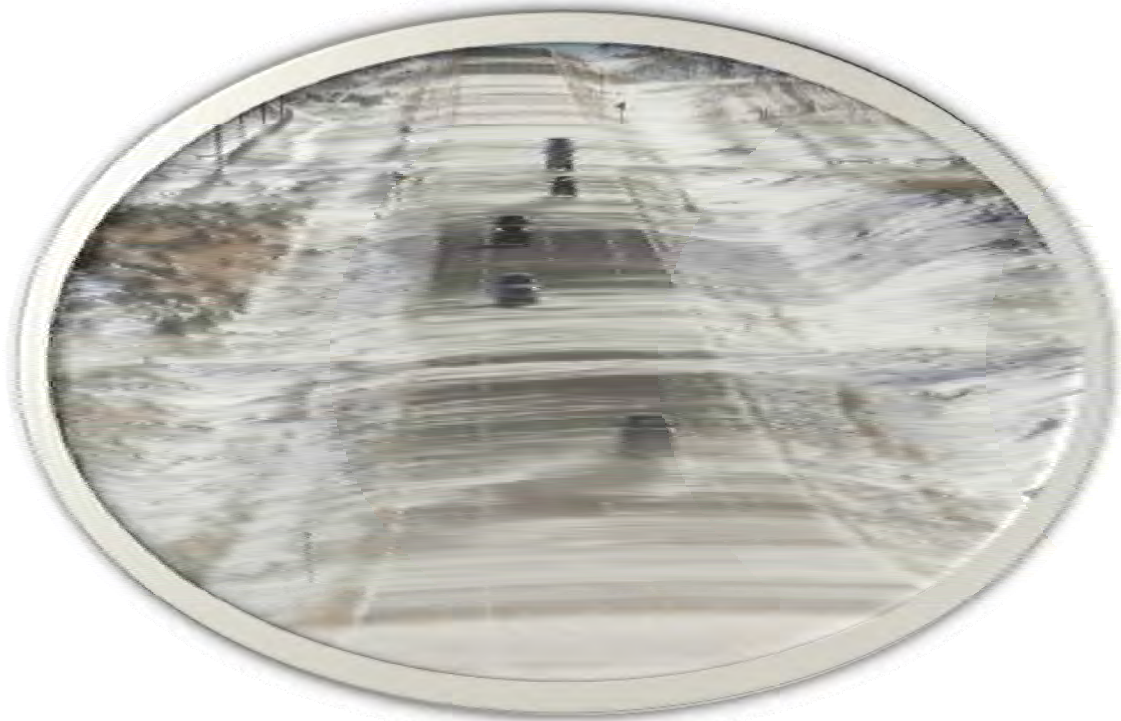

REVISED: 10/01/17

Prepared by:

State Maintenance Engineer's Office



PREFACE

This book uses the Highway Features Planning Tool as the foundation for roadway information. It also includes the following information:

- Maintenance crews
- Maintenance sections and breaks by crew
- Shop locations
- Port of Entry locations
- Rest Area locations
- Seasonal road closure locations
- Road closure gate locations (**NOT including gates on ramps**)
- Road Weather Information System (RWIS) sensors
- Variable Message Sign (VMS) locations
- Structure ID's [#; *] ID#; * *structure type or lane*
- Federal Roadway Classifications by number
- At grade railroad crossing ID numbers
- Variable Speed Limit Sign (VSL)
- WYO-Link tower sites
- Airport maintenance sections

PURPOSE

The WYDOT Maintenance Section Reference Book provides a snap shot reference of maintenance sections by county, key locations by reference markers (RM), routes, main line (ML) number and maintenance section maps by county with routes identified by road classification. This book also includes statewide location information for the following WYDOT facilities:

- Offices and shops
- Rest areas and information centers
- Ports of entry
- Airports
- Remote facilities
- Road weather information system (RWIS) sites
- Radio tower sites
- Interchange layouts

REFERENCE MARKER SYSTEM

The WYDOT reference marker system is used to establish a uniform method of highway designation that provides detailed information and is useable by all WYDOT divisions. Enforcement agencies use the markers to help report highway accident or incident locations and highway travelers refer to the markers as a location reference.

Reference markers should be placed at one mile increments along each route and at all of the following locations:

- **State route intersections**
- **District boundaries**
- **County lines**
- **State lines**
- **Place names (unincorporated)**
- **Major structures**

INSTALLATION

On interstate and multilane highways, reference markers are installed in each direction of travel. Reference markers on the southbound or westbound roadways are installed in descending order and reference markers in the northbound or eastbound roadways

are installed in ascending order. Reference marker installation is based on distance measurement on the northbound or eastbound roadways. The reference marker for the southbound or westbound roadways will be installed directly opposite the northbound or eastbound markers. Zero distance begins at the south and west Wyoming state lines or at the south and west terminus points where routes begin within Wyoming.

On two-lane highways, reference markers are installed on the right side of the roadway with a marker mounted on a post to face each direction of traffic.

Reference markers are installed in line with delineators or two feet back from the face of any curb if no sidewalk exists.

Reference marker placement at structures may be placed at the beginning of the structure in each direction of travel. Stenciled markers should also be used on a structure where possible.

If a reference marker cannot be installed in the correct location, it may be moved in either direction as much as 50 feet. If the reference marker cannot be placed within 50 feet of the correct location, it should be omitted.

The WYDOT Planning Program should be notified when a reference marker is omitted so that map corrections can be made.

EQUATIONS

This book shows equations when necessary. Equations are typically the result of a new alignment. The **AHEAD (AH)** and **BACK (BK)** reference markers are installed at the first full location point on either side of an equation location. When a construction project lengthens a route by one or more miles, **BACK (BK)** reference markers should be placed with the first set of duplicate reference marker numbers.

When reporting an accident or anything else regarding a portion of road with an equation, it is important that the equation designation AH or BK be included with the reference marker number. This way a location will be correctly identified.

MAPS

District maps are included in this book with colored routes that show each district's level of snow removal service according to the district's snow removal plan.

County maps are also included in this book with colored routes that show highway functional classes. Maintenance QA/QC groups the twelve highway functional classes as determined by the WYDOT Planning Program into five groups as shown below:

Maintenance QA/QC Highway Functional Class Groups	
Group	Description & Color on Map
I	#1 Rural and #11 Urban Interstate (gray)
II	#14 Urban Principal Arterial Other & #12 Urban Principal Arterial Other Expressway (NHS) (red)
III	# 16 Urban Minor Arterial, #17 Urban Collector & #19 Urban Local (non NHS) (green)
IV	#3 Rural Principal Arterial Other (NHS) (brown)
V	# 6 Rural Minor Arterial, #7 Rural Major Collector, #8 Rural Minor Collector & # 9 Rural Local (non NHS) (blue)

BOOK UPDATES

All portions of this book are kept as current as possible. Please notify the State Maintenance Engineer's Office if you find errors and omissions that need to be corrected in future publications.

ABBREVIATIONS

The following list of abbreviations is used in the location descriptions for maintenance sections:

Description	Abbreviation	Description	Abbreviation
Air Force Base	AFB	North Urban Limits	NUL
Variable Message Sign	VMS	Optional turn (free right)	OT
Construction	Const.	Railroad	RR
Conversion	Conv.	Ramp	RP
Continued	-cont-	Reference Marker	RM
County	Co.	River	Rv.
Creek	Cr.	Road	Rd.
Department	Dept.	Road Weather Information System	RWIS
East	E.	Separation	Sep.
Eastbound	EB	Service Road	Sv. Rd.
East Corporate Limits	ECL	South	S.
East Urban Limits	EUL	Southbound	SB
Fort	Ft.	South Corporate Limits	SCL
Interchange	Int.	South Urban Limits	SUL
Interstate	I	State Highway	SH
Junction	Jct.	State Highway System	SHS
Main Line	ML	Turnout	TO
Maintenance	Maint.	Variable Speed Limit Sign	VSL
Mountain	Mtn.	West	W.
National Highway System	NHS	Westbound	WB
North	N.	West Corporate Limits	WCL
Northbound	NB	West Urban Limits	WUL
North Corporate Limits	NCL	Wye Connections	Wye Conn

County Abbreviations					
County Name	County #	Abbreviation	County Name	County #	Abbreviation
Albany	5	AL	Natrona	1	NA
Big Horn	9	BH	Niobrara	14	NI
Campbell	17	CL	Park	11	PA
Carbon	6	CB	Platte	8	PL
Converse	13	CO	Sheridan	3	SH
Crook	18	CR	Sublette	23	SB
Fremont	10	FR	Sweetwater	4	SW
Goshen	7	GO	Teton	22	TE
Hot Springs	15	HS	Uinta	19	UI
Johnson	16	JO	Washakie	20	WA
Laramie	2	LA	Weston	21	WE
Lincoln	12	LN			

District Maintenance Crews			
District One – 11 Crews			
District Office - Laramie			
Crew	Location	Crew	Location
1031	Laramie	1038	Arlington
1032	Laramie	1039	Pine Bluffs
1034	Cheyenne	1040	Elk Mountain
1035	Cheyenne	1041	Rawlins
1036	Medicine Bow	1042	Saratoga
1037	Baggs		
District Two – 12 Crews			
District Office - Casper			
2031	Casper	2037	Midwest
2032	Casper	2038	Torrington
2033	Chugwater	2039	Wheatland
2034	Douglas	2040	Kaycee
2035	Lusk	2041	Shirley Rim
2036	Muddy Gap	2042	Casper
District Three – 14 Crews			
District Office - Rock Springs			
3031	Rock Springs	3038	Granger
3032	Rock Springs	3039	Jackson
3033	Afton	3040	Kemmerer
3034	Cokeville	3041	Labarge
3035	Pinedale	3042	Lyman
3036	Evanston	3043	Patrick Draw
3037	Farson	3044	Wamsutter
District Four – 10 Crews			
District Office - Sheridan			
4033	Sheridan	4039	Hulett
4035	Gillette	4040	Moorcroft
4036	Buffalo	4041	Newcastle
4037	Pole Creek	4042	Sundance
4038	Burgess Junction	4043	Reno Junction
District Five – 12 Crews			
District Office - Basin			
5031	Basin	5037	Shoshoni
5032	Cody	5038	South Pass
5033	Dubois	5039	Tensleep
5034	Lander	5040	Thermopolis
5035	Lovell	5041	Worland
5036	Meeteetse	5042	Riverton

RADIO TOWER SITES (District 1)								
Dist	Maint. Sect.	Cat.	Start RM	End RM	Tower Name	Maint. Site	Closest ML #	Closest Route
LOCATION					COMMENTS			
1	TR 01A	TS	52.075	52.075	Baggs Hill	Baggs	ML 18B	WY 789
<i>East of Baggs</i>					<i>off WY 789</i>			
1	TR 01B	TS	12.000	12.000	Divide Hill	Rawlins	ML 18B	WY 789
<i>West of Rawlins</i>					<i>12 miles South of I-80 @exit 187, off WY 789</i>			
1	TR 01C	TS	8.590	8.590	Nine Mile Hill	Rawlins	ML 21B	US 287
<i>North of Rawlins</i>					<i>6.6 miles North of Rawlins bypass, off US 287</i>			
1	TR 01D	TS	16.465	16.465	North Albin	Pine Bluffs	ML 1105B	WY 216
<i>North of Albin</i>					<i>17 miles north of Albin, off WY 216</i>			
1	TR 01G	TS	5.797	5.797	Russell Hill	Pine Bluffs	ML 1104B	WY 215
<i>North of Pine Bluffs</i>					<i>off WY 215 onto county road 218</i>			
1	TR 01H	TS	36.465	36.465	Sherman Beacon Hill	Laramie	ML 107B	WY 210
<i>East of Laramie</i>					<i>off WY 210 onto West Pilot Hill Rd.</i>			
1	TR 01J	TS	132.522	132.522	Shirley Mtn.	Medicine Bow	ML 77B	WY 77
<i>North of Medicine Bow</i>					<i>off WY 77 onto county road #102</i>			
1	TR 01K	TS	290.440	290.440	Strouss Hill	Laramie	ML 80I/D	I-80
<i>West of Laramie</i>					<i>off I-80 exit 290 on county road 59</i>			
1	TR 01M	TS	1.370	1.370	US 85 South	Cheyenne	ML 85B	US 85
<i>South of Cheyenne</i>					<i>off US 85</i>			
1	TR 01N	TS	47.250	47.250	Whitcomb Hill	Cheyenne	ML 25I/D	I-25
<i>North of Cheyenne</i>					<i>36 miles north of Cheyenne, off I-25</i>			
1	TR 01P	TS	36.440	36.440	North Flat Top	Baggs	ML 18B	WY 789
<i>North of Baggs</i>					<i>off WY 789 onto Robber's Gulch Rd.</i>			
1	TR 01S	TS	3.000	3.000	Jelm Mtn.	Laramie	ML 101B	WY 10
<i>Southwest of laramie</i>					<i>off WY 10</i>			
1	TR 01T	TS	27.800	27.800	Whitaker	Cheyenne	ML 25I/D	I-25
<i>North of Cheyenne</i>					<i>15 miles north of Cheyenne, off I-25</i>			
1	TR 01U	TS	42.040	42.040	Pinkham Mountain	Jelm, WY	ML26B	WY 230
<i>SW of Jelm, WY</i>					<i>6.8 Miles into Colorado, from 42.04 WY 230 (State line)</i>			
1	TR 01V	TS	255.600	255.600	Halleck Ridge	Elk Mountain	ML 80I	I-80
<i>West of Elk Mountain</i>					<i>6.6 Miles west of RM 255.6 (I-80) on Rattlesnack Pass Rd.</i>			

- continued on next page -

- continued -

RADIO TOWER SITES (District 2)								
Dist	Maint. Sect.	Cat.	Start RM	End RM	Tower Name	Maint. Site	Closest ML #	Closest Route
LOCATION					COMMENTS			
2	TR 02A	TS	8.909	8.909	Casper Mtn.	Casper	ML 1301B	WY 251
<i>South of Casper</i>					<i>off WY 251 onto county road section</i>			
2	TR 02B	TS	11.280	11.280	Flat Top	Douglas	ML 40B	US 18/20
<i>North of Shawnee</i>					<i>off US 18/20 onto county road north @Shawnee</i>			
2	TR 02C	TS	49.200	49.200	Lonetree	Douglas	ML 43B	WY 59
<i>North of Bill WY.</i>					<i>off WY 59 on county road #34</i>			
2	TR 02D	TS	16.960	16.960	Morton Hill	Douglas	ML 43B	WY 59
<i>North of Douglas</i>					<i>off WY 59</i>			
2	TR 02G	TS	1.500	1.500	Muddy Gap Hill	Muddy Gap	ML 20B	US 287
<i>Southwest of Muddy gap</i>					<i>off US 287</i>			
2	TR 02H	TS	100.333	100.333	Pine Ridge	Wheatland	ML 319B	WY 319
<i>North of Wheatland</i>					<i>off I-25 @exit 100 onto WY 319 north</i>			
2	TR 02J	TS	104.136	104.136	77 Hill	Lusk	ML 1401B	WY 270
<i>North of Manville</i>					<i>off WY 270</i>			
2	TR 02M	TS	11.911	11.911	Virgin Hill	Wheatland	ML 1604B	WY 316
<i>East of Wheatland</i>					<i>off WY 316 end SHS onto Antelope Gulch Rd.</i>			
2	TR 02N	TS	246.560	246.560	Tisdale Mtn.	Kaycee	ML 25I/D	I-25
<i>South of Kaycee</i>					<i>off I-25 @ exit 246</i>			

- continued on next page -

- continued -

RADIO TOWER SITES (District 3)								
Dist	Maint. Sect.	Cat.	Start RM	End RM	Tower Name	Maint. Site	Closest ML #	Closest Route
LOCATION					COMMENTS			
3	TR 03A	TS	6.300	6.300	Aspen Mtn.	Rock Springs	ML 1903B	WY 430
<i>South of Rock Springs</i>					<i>off WY 430 onto county road #27</i>			
3	TR 03B	TS	53.310	53.310	Church Buttes	Lyman	ML 80I/D	I-80
<i>Northeast of Lyman</i>					<i>off I-80 @exit 53 onto Church Buttes Rd.</i>			
3	TR 03C	TS	158.550	158.550	Delaney Rim	Wamsutter	ML 80I/D	I-80
<i>South of Tipton</i>					<i>off I-80 @exit 158 @Tipton onto road through town</i>			
3	TR 03D	TS	13.860	13.860	First Divide	Evanston	ML 80I/D	I-80
<i>East of Evanston</i>					<i>off I-80 @exit 13</i>			
3	TR 03G	TS	4.486	4.486	Hogsback Ridge	Labarge	ML 1203B	WY 235
<i>West of larbarga</i>					<i>off WY 235 on county road 134</i>			
3	TR 03H	TS	37.645	37.645	Oyster Ridge	Kemmerer	ML 11B	US 189
<i>East of Kemmerer</i>					<i>off US 189 onto Aspen Ave.</i>			
3	TR 03J	TS	38.427	38.427	Sage Jct. / Twin buttes	Cokeville	ML 12B	US 30
<i>South of Cokeville</i>					<i>off US 30 onto Rock Creek county road</i>			
3	TR 03K	TS	69.810	69.810	Salt Pass	Afton	ML 10B	US 89
<i>South of Afton</i>					<i>off US 89</i>			
3	TR 03M	TS	152.478	152.478	Snow King	Jackson	ML 10B	US 26/89
<i>South of Jackson</i>					<i>off US 26/89/191</i>			
3	TR 03N	TS	0.000	0.000	Hell Hole Ridge	Cokeville	ML 12B	US 30
<i>Northwest of Cokeville "In Idaho"</i>					<i>End SHS at WY/ID border</i>			
3	TR 03P	TS	94.120	94.120	Narrow Hill	Afton	ML 10B	US 89
<i>North of Afton</i>					<i>off US 89 across from WY 238 north</i>			
3	TR 03R	TS	6.630	6.630	Rendezvous Peak	Jackson	ML 2001	WY 390
					<i>off WY 390 at Teton Village Rd</i>			
3	TR 03T	TS	184.290	184.290	Latham	Wamsutter	ML80I/D	I-80
<i>Northeast of Wamsutter</i>					<i>off I-80 @exit 184</i>			
3	TR 03W	TS	120.940	120.940	Aspen Ridge	Pinedale	ML 13B	US 189
<i>North of Daniel</i>					<i>off US 189/191</i>			
3	TR 03X	TS	3.520	3.520	Mansface	Green River	ML 1900B	WY 530
<i>SW of Green River</i>					<i>off WY 530 RM 3.52 (2.25 miles West on Access Rd to Mansface Hill)</i>			
3	TR 03Y	TS	108.650	108.650	Black Mountain	Alpine	ML10B	US 89
<i>SW of Alpine</i>					<i>off US 89 (108.65) west on Jack Knife Rd. to NF 070 then north (Idaho) (10.5 miles)</i>			
3	TR 03Z	TS	99.280	99.280	White Pine	Pinedale	ML 13B	1191
<i>NNE of Pinedale</i>					<i>off 191 at Fremont Lake Rd approx. 12 Miles NNE</i>			

- continued on next page -

- continued -

RADIO TOWER SITES (District 4)								
Dist	Maint. Sect.	Cat.	Start RM	End RM	Tower Name	Maint. Site	Closest ML #	Closest Route
LOCATION					COMMENTS			
4	TR 04A	TS	35.617	35.617	Banner Ridge	Sheridan	ML 60B	US 87
<i>South of Sheridan close to Story WY.</i>					<i>off US 87 on county road 28</i>			
4	TR 04B	TS	15.683	15.683	Jim Cr. Hill	Sheridan	ML 302B	US 14/16
<i>Southeast of Sheridan</i>					<i>off US 14/16</i>			
4	TR 04C	TS	237.445	237.445	Mount Pisgah	Newcastle	ML 85B	US 85
<i>North of Newcastle</i>					<i>off US 85 @Flying V Ranch (south Approach)</i>			
4	TR 04D	TS	43.475	43.475	Pumkin Buttes	Reno Jct.	ML 300B	WY 50
<i>West of Wright WY.</i>					<i>off WY 50 onto Christinson road</i>			
4	TR 04G	TS	141.240	141.240	Rozet Hill	Gillette	ML 90I/D	I-90
<i>North of Rozet</i>					<i>off I-90 @exit 141</i>			
4	TR 04H	TS	291.080	291.080	Tisdale Divide	Buffalo	ML 25I/D	I-28
<i>South of Buffalo</i>					<i>off I-25 exit 291, west onto Trabing Rd.</i>			
4	TR 04J	TS	199.340	199.340	Warren Peak	Sundance	ML 607B	US 14
<i>South of Sundance</i>					<i>off US 14 onto Warren Peak Rd. north</i>			
4	TR 04K	TS	72.797	72.797	Chicken Cr.	Gillette	ML 302B	US 14/16
<i>Northeast of Gillette</i>					<i>off US 14/16 close to "Spotted Horse WY"</i>			
4	TR 04L	TS	39.540	39.540	Duncan Lake	Sheridan	ML 37B	US 14
<i>WSW of Sheridan</i>					<i>East off US 14 (39.54) approx. 4 miles on Dnucan Lake Rd.</i>			

- continued on next page -

- continued -

RADIO TOWER SITES (District 5)								
Dist	Maint. Sect.	Cat.	Start RM	End RM	Tower Name	Maint. Site	Closest ML #	Closest Route
LOCATION					COMMENTS			
5	TR 05A	TS	48.470	48.470	Cedar Mtn.	Cody	ML 31B	US 14/16
<i>Southwest of Cody</i>					<i>off US 14/16/20</i>			
5	TR 05B	TS	109.200	109.200	Copper Mtn.	Shoshoni	ML 34B	US 20
<i>Northeast of Shoshoni</i>					<i>off US 20 onto Birdseye Rd.</i>			
5	TR 05C	TS	32.791	32.791	Dead Indian Hill	Cody	ML 1507B	WY 296
<i>North of Cody</i>					<i>off WY 296</i>			
5	TR 05D	TS	27.160	27.160	Winkelman Dome	Lander	ML 15B	US 287
<i>North of Lander</i>					<i>off WY 132 close to Ft. Washakie WY.</i>			
5	TR 05G	TS	23.030	23.030	Jade Mtn.	Lander	ML 20B	US 287
<i>Jeffery City ECL</i>					<i>off US 287/WY 789 onto Crooks gap Rd. south</i>			
5	TR 05H	TS	70.000	70.000	McCullough Peaks	Cody	ML 31B	US14/16/20
<i>East of Cody</i>					<i>off US 14 @RM 70.0 "not constructed yet"</i>			
5	TR 05J	TS	45.875	45.875	South Pass	South Pass	ML 14B	WY 28
<i>Close to South Pass maintenance camp</i>					<i>off WY 28</i>			
5	TR 05K	TS	196.574	196.574	Torchlite Hill	Basin	ML 34B	US 16/20
<i>Northeast of Basin</i>					<i>off US 16 Basin NCL onto Lane 42C Torchlite Rd.</i>			
5	TR 05M	TS	50.690	50.690	Waltman Hill	Shoshoni	ML 34B	US 20/26
<i>East of Shoshoni</i>					<i>off US 20/26 south of Waltman</i>			
5	TR 05N	TS	53.414	53.414	Windy Ridge	Dubois	ML 30B	US 26
<i>Northwest of Dubois</i>					<i>off US 26</i>			
5	TR 05P	TS	169.413	169.413	Rattlesnake Ridge	Worland	ML 36B	US 16/20
<i>North of Worland</i>					<i>off US 16 onto county road 11</i>			
5	TR 05R	TS	48.934	48.934	3 Mile Hill	Meeteetse	ML 33B	WY 120
<i>Southeast of Meeteetse</i>					<i>off WY 120</i>			
5	TR 05S	TS	0.850	0.850	Thermopolis Owl Creek	Thermopolis	ML 33B	WY 120
<i>West of Thermopolis</i>					<i>Off WY 120, then approx. 1.9 miles on Owl Creek Rd.</i>			
5	TR 05T	TS	83.325	83.325	Lander Landfill	Lander	ML 20B	WY 789
<i>East of Lander</i>					<i>Off WY 789, Then approx. 1.9 miles on Beebe Dr.</i>			

OFF Highway Sites

<i>County</i>	<i>District</i>	<i>Route</i>	<i>Maint. Sect.</i>	<i>RM</i>	<i>Cat.</i>	<i>SITE</i>
Ports of Entry						
Albany	1	US 287	AL 02P	401.960	PO	Laramie
Carbon	1	WY 789	CB 08P	52.070	PO	Baggs
Laramie	1	I-80	LA 01P	371.890	PO	Cheyenne
Laramie	1	I-25	LA 03P	6.350	PO	Cheyenne
Laramie	1	US 85	LA 05P	4.120	PO	Cheyenne
Goshen	2	US 26/85	GO 01P	95.360	PO	Torrington
Natrona	2	WY 254	NA 10P	1.590	PO	Casper
Niobrara	2	US 18/20	NI 02P	40.790	PO	Lusk
Lincoln	3	US 30	LN 03P	52.490	PO	Kemmerer
Lincoln	3	US 26	LN 13P	0.550	PO	Alpine
Uinta	3	I-80	UI 01P	0.400	PO	Evanston
Campbell	4	US 14/16	CL 02P	127.480	PO	Gillette
Crook	4	I-90	CR 01P	189.000	PO	Sundance
Sheridan	4	I-90	SH 01P	16.340	PO	Sheridan
Weston	4	US 16	WE 02P	247.340	PO	Newcastle
Park	5	US 310	BH 03P	254.700	PO	Frannie

<i>County</i>	<i>District</i>	<i>Route</i>	<i>Maint. Sect.</i>	<i>RM</i>	<i>Cat.</i>	<i>SITE</i>
Department Sites						
Albany	1	US 287	DH 01A	401.960	YD	Laramie
Carbon	1	WY 72	EM 01A	15.200	YD	Elk Mtn.
Carbon	1	WY 13	AR 01A	16.890	YD	Arlington
Carbon	1	WY 130	SG 01A	23.200	YD	Saratoga
Carbon	1	WY 789	BG 01A	51.900	YD	Baggs
Carbon	1	I-80	RW 01A	215.350	YD	Rawlins
Carbon	1	US 30/287	MB 01A	270.290	YD	Medicine Bow
Laramie	1	I-25	HQ 01A	12.700	YD	Cheyenne
Laramie	1	US 30	PB 01A	402.670	YD	Pine Bluffs
Carbon	2	US 287	MG 02A	43.260	YD	Muddy Gap
Carbon	2	WY 487	SR 02A	45.100	YD	Shirley Rim
Converse	2	I-25 SR	DG 02B	8.951	YD	Douglas
Goshen	2	WY 159	TT 02A	0.580	YD	Torrington
Johnson	2	WY 192	KC 02A	0.150	YD	Kaycee
Natrona	2	WY 387	MW 02A	99.370	YD	Midwest
Natrona	2	I-25	DH 02A	186.790	YD	Casper
Niobrara	2	US 85	LK 02A	150.180	YD	Lusk
Platte	2	WY 321	CW 02A	55.660	YD	Chugwater
Platte	2	US 87 BUS.	WL 02A	79.070	YD	Wheatland
Platte	2	I-25 SR	WL 02B	3.740	YD	Wheatland

- continued next page -

<i>County</i>	<i>District</i>	<i>Route</i>	<i>Maint. Sect.</i>	<i>RM</i>	<i>Cat.</i>	<i>SITE</i>
Department Sites						
Lincoln	3	WY 232	CV 03A	0.140	YD	Cokeville
Lincoln	3	US 189	KM 03A	38.070	YD	Kemmerer
Lincoln	3	US 189	LB 03A	84.890	YD	LaBarge
Lincoln	3	US 89	AF 03A	86.070	YD	Afton
Sublette	3	US 191	PN 03A	100.590	YD	Pinedale
Sweetwater	3	US 191	DH 03A	2.300	YD	Rock Springs
Sweetwater	3	US 191	FS 03A	41.000	YD	Farson
Sweetwater	3	US 30	GN 03A	93.850	YD	Granger
Sweetwater	3	I-80	PD 03A	146.850	YD	Patrick Draw
Sweetwater	3	I-80	WS 03A	173.410	YD	Wamsutter
Teton	3	US 26/89/189/191	JK 03A	145.250	YD	Jackson
Uinta	3	WY 89	ET 03A	1.040	YD	Evanston
Uinta	3	I-80 BUS.	LM 03A	43.310	YD	Lyman
Campbell	4	WY 59	RJ 04A	71.990	YD	Reno Jct.
Campbell	4	I-90	GL 04A	129.100	YD	Gillette
Crook	4	WY 24	HL 04A	14.840	YD	Hulett
Crook	4	I-90	MC 04A	153.410	YD	Moorcroft
Crook	4	I-90	SD 04A	189.000	YD	Sundance
Johnson	4	US 16	PC 04A	69.300	YD	Pole Cr.
Johnson	4	US 16	BF 04A	91.540	YD	Buffalo
Johnson	4	I-25	BF 04B	298.020	YD	Future Buffalo site
Sheridan	4	WY 334	DH 04A	0.000	YD	Sheridan
Sheridan	4	WY 336	DH 04B	1.450	YD	Future Sheridan site
Sheridan	4	US 14A	BJ 04A	98.640	YD	Burgess Jct.
Weston	4	US 16 Bypass	NC 04A	248.820	YD	Newcastle
Park	5	US 14/16/20	CD 05A	55.140	YD	Cody
Big Horn	5	US 16/20	DH 05A	196.420	YD	Basin
Big Horn	5	US 310 WY 789	LV 05A	236.060	YD	Lovell
Fremont	5	US 26/287	TG 05A	33.680	YD	Togwotee
Fremont	5	WY 28 SR	SP 05A	49.200	YD	South Pass
Fremont	5	US 26/287	DB 05A	54.760	YD	Dubois
Fremont	5	US 287 WY 789	LD 05A	81.050	YD	Lander
Fremont	5	US 20/26	SS 05A	99.470	YD	Shoshoni
Fremont	5	US 26/287	RT 05A	130.580	YD	Riverton
Hot Springs	5	US 20	TM 05A	130.860	YD	Thermopolis
Park	5	WY 296	RC 05A	20.400	YD	Russell Cr.
Park	5	WY 120	MT 05A	50.380	YD	Meeteetse
Washakie	5	WY 433	WL 05A	0.250	YD	Worland
Washakie	5	US 16	TS 05A	28.010	YD	Tensleep

<i>County</i>	<i>District</i>	<i>Route</i>	<i>Maint. Sect.</i>	<i>RM</i>	<i>Cat.*</i>	<i>SITE</i>
Remote Sites (Loader Sheds, Scale Houses & Salt/Sand Sheds)						
Albany	1	I-80	AL01B	335.400	SSS	Buford
Albany	1	I-80 SR	AL01J	1.400	LS/SSS	Summit
Albany	1	US 30/287	AL02A	290.100	LS/SSS	Rock River
Carbon	1	I-80	CB01A	201.164	LS/SSS	Daley
Carbon	1	I-80	CB01A	210.500	SH	Rawlins
Carbon	1	I-80	CB01B	267.186	LS/SSS	Wagonhound
Carbon	1	I-80	CB01C	279.859	LS/SSS	Cooper Cove
Carbon	1	US 30/287	CB19A	252..6	LS/SSS	Hanna
Carbon	1	WY 130/230	CB05A	0.600	LS/SSS	Wolcott Jct
Laramie	1	I-80	LA01A	343.600	LS/SSS	Harriman
Laramie	1	I-80 SR	LA01Q	9.100	SSS	Hillsdale
Laramie	1	WY 216	LA12A	0.300	SSS	Gun Barrel
Laramie	1	WY 223	LA18A	0.200	LS	Terry Ranch
Laramie	1	WY 223	LA18A	0.700	SSS	Terry Ranch
Sweetwater	1	I-80	SW01A	187.204	SSS	Creston Jct
Cambell	2	WY 387	CL03A	131.793	LS	Pine Tree Jct
Converse	2	I-25	CO01A	165.909	LS/SSS	Glenrock
Laramie	2	I-25 SR	LA03K	6.500	LS/SSS	Nimmo
Natrona	2	US 20/26	NA05A	39.608	LS/SSS	Powder River
Natrona	2	WY 220	NA04B	86.500	LS/SSS	Alcova
Natrona	2	WY 254	CA02A	1.880	SSS	Amoco Pit
Platte	2	I-25	PL01B	111.675	LS/SSS	Glendo
Platte	2	I-25 SR	WL02B	3.740	LS/SS	Wheatland S. Yard
Platte	2	US 26	GU02A	16.500	LS/SSS	Guernsey Pit
Lincoln	3	US 30	CV 981	30.500	LS	Sage Jct
Lincoln	3	US 89	AF 981	118.322	LS	Alpine
Sublette	3	US 189	SB01B	107.300	SH	Marbleton
Sublette	3	US 191	FS 982	75.500	LS/SH	Sand Draw
Sublette	3	US 191	SB02D	125.800	LS	Rim
Sweetwater	3	I-80	PD 981	130.840	LS	Point of Rocks
Sweetwater	3	I-80	WS 981	158.545	LS	Tipton
Sweetwater	3	US 191	RS 981	2.900	LS	Rock Springs N. Yard
Sweetwater	3	WY 28	FS 981	102.000	LS	WY 28 / WY 372 Jct
Sweetwater	3	WY 374	SW02B	90.040	LS	Green River
Teton	3	US 26/89/189/191	TE01A	147.400	SSS	Jackson N. Yard
Teton	3	WY 22	TE04A	7.000	SSS	Teton Pass
Teton	3	WY 22	TE04A	17.494	SH	Teton Pass
Uinta	3	I-80	ET 981	18.293	LS	Lazear
Uinta	3	I-80	LM 981	30.398	LS	Bigelow
Uinta	3	I-80	UI01B	34.740	SH	Ft. Bridger
Crook	4	US 212	CR05A	13.400	LS	Colony
Johnson	4	I-90	JO03B	88.700	LS/SSS	Powder River
Niobrara	4	US 18	NI03A	0.100	LS/SSS	Mule Creek
Sheridan	4	WY 341	SH16A	0.100	LS/SSS	Arvada

*LS - Loader Shed, SH - Scale House, SS - Salt Shed, SSS - Salt/Sand Shed

^- continued next page -

<i>County</i>	<i>District</i>	<i>Route</i>	<i>Maint. Sect.</i>	<i>RM</i>	<i>Cat.*</i>	<i>SITE</i>
Remote Sites (Loader Sheds, Scale Houses & Salt/Sand Sheds)						
Fremont	5	US 20/26	FR04A	70.000	LS	US 20/26
Fremont	5	US 26/287	FR03A	98.790	SSS	Diversion Dam
Fremont	5	US 287	FR02B	42.200	LS/SSS	Sweetwater Station
Natrona	5	US 20/26	NA05A	53.030	LS/SSS	Waltman
Park	5	US 14/16/20	PA01B	54.800	SH	Cody
Park	5	US14A	PA02A	21.750	SSS	US14A

*LS - Loader Shed, SH - Scale House, SS - Salt Shed, SSS - Salt/Sand Shed

<i>County</i>	<i>District</i>	<i>Route</i>	<i>Maint. Sect.</i>	<i>RM</i>	<i>Cat.*</i>	<i>SITE</i>
Rest Areas / Information Centers						
Albany	1	I-80	AL 01R	323.050	RA	Summit
Carbon	1	I-80	CB 01R	228.340	RA	Ft. Steele
Carbon	1	I-80	CB 01S	267.190	RA	Wagonhound
Laramie	1	I-80	LA 01R	401.460	RA	Pine Bluffs
Laramie	1	I-25	LA03W	4.850	RA	SE Welcome Center
Laramie	1	US 85	LA 05R	53.800	RA	Meriden
Carbon	2	WY 487	CB 13R	45.100	RA	Shirley Rim
Converse	2	I-25	CO 01R	126.470	RA	Orin Jct.
Johnson	2	I-25	JO 01R	254.250	RA	Kaycee
Natrona	2	WY 220	NA 04R	62.830	RA	Independence Rock
Niobrara	2	US 18/20	NI 02R	39.290	RA	Lusk
Platte	2	I-25	PL 01R	92.370	RA	Dwyer Jct.
Platte	2	US 26	PL 04R	17.800	RA	Guernsey
Platte	2	I-25	PL 25R	54.590	RA	Chugwater
Lincoln	3	US 89	LN 01R	97.490	RA	Star Valley
Sweetwater	3	I-80	SW 80R	143.500	RA	Bitter Cr. WB
Sweetwater	3	I-80	SW 80S	144.200	RA	Bitter Cr. EB
Uinta	3	I-80	UI 01R	41.990	RA	Lyman
Crook	4	I-90	CR 01R	153.410	RA	Moorcroft
Crook	4	I-90	CR 01S	189.000	RA	Sundance
Crook	4	I-90	CR 01W	199.310	RA	NE Welcome Center
Johnson	4	I-90	JO 03R	88.670	RA	Powder River
Niobrara	4	US 85	NI 01R	196.040	RA	Mule Cr.
Sheridan	4	I-90	SH 01R	23.150	RA	Sheridan
Weston	4	US 16	WE 02R	220.800	RA	Upton
Big Horn	5	US 14/16/20	BH 03R	206.700	RA	Greybull
Fremont	5	US 26/287	FR 03R	96.380	RA	Diversion Dam
Fremont	5	WY 28	FR 05R	34.310	RA	South Pass
Fremont	5	WY 135	FR 10R	34.590	RA	Sweetwater Station
Hot Springs	5	WY 120	HS 01R	37.100	RA	Gooseberry Cr.
Natrona	5	US 20/26	NA 05R	53.170	RA	Waltman

Statewide RWIS sites

RWIS = remote weather information site

District	ML #	Route	Maint. Sect.	Map #	RM	DIR	Name	Under Const
1	22	WY 230	CB 11A	7	113.200	D	Skyline	
1	23	US 287	AL 02C	8	420.400	I	Pumpkin Vine	
1	25	I-25	LA 03A	9	3.290	D	Wyo hill (1)	
1	25	I-25	LA 03A	10	3.520	D	Wyo hill (2)	
1	25	I-25	LA 03A	11	4.020	D	Wyo hill (3)	
1 & 2	25	I-25	LA 03A	12	30.200	D	Whitaker	
1 & 2	25	I-25	LA 03B	76	46.770	D	Bear Creek	
1	80	I-80	CB 01A	33	221.700	I	Sinclair	
1	80	I-80	CB 01A	34	234.660	I	Walcott Junction	
1	80	I-80	CB 01B	35	244.800	I	Dana Ridge	
1	80	I-80	CB 01B	36	249.100	I	RM 249	
1	80	I-80	CB 01B	37	252.160	I	Halleck Ridge	
1	80	I-80	CB 01B	38	256.170	I	Elk Mountain	
1	80	I-80	CB 01B	39	262.000	I	County Road 402	
1	80	I-80	CB 01B	40	266.580	D	Wagonhound	
1	80	I-80	CB 01C	41	269.500	D	Foote Creek	
1	80	I-80	CB 01C	42	271.800	D	Arlington	
1	80	I-80	CB 01C	43	273.850	I	Arlington East	
1	80	I-80	CB 01C	44	279.360	D	Cooper Cove	
1	80	I-80	AL 01A	45	283.750	I	Strouss Hill	
1	80	I-80	AL 01A	46	289.500	D	Quealy Dome	
1	80	I-80	AL 01A	47	297.660	D	Herrick Lane	
1	80	I-80	AL 01B	48	325.800	I	Summit East	
1	80	I-80	AL 01B	49	329.400	I	Vedauwoo	
1	80	I-80	AL 01B	68	333.320	I	Lone Tree	
1	80	I-80	AL 01B	69	336.500	D	Buford East	
1	80	I-80	LA 01A	50	340.500	D	Remount	
1	80	I-80	LA 01A	70	347.690	D	Otto Road	
1	80	I-80	LA 01A	71	353.000	D	RM 353	
1	80	I-80	LA 01A	72	373.000	D	Cheyenne East	
1	85	US 85	LA 05B	51	46.800	D	Gun Barrel	
1	107	WY-210	LA 06A		21.520	D	Wildcat Trail	
1	107	WY-210	LA 06A		24.550	I	Hynds Lodge Rd	
2	21	WY 220	NA 04A	6	80.100	D	Pathfinder Hill	
2	24	WY-487	CB 13B	77	37.000	I	Shirley Rim	
2 & 1	25	I-25	LA 03A	12	30.200	D	Whitaker	
2 & 1	25	I-25	LA 03B	76	46.770	D	Bear Creek	
2	25	I-25	PL 01A	13	70.800	D	Bordeaux	
2	25	I-25	PL 01B	14	98.700	D	Coleman	

- continued next page -

Statewide RWIS sites

RWIS = remote weather information site

District	ML #	Route	Maint. Sect.	Map #	RM	DIR	Name	Under Const
2	25	I-25	PL 01C		116.090	I	RM 116.09	New 2017
2	25	I-25	PL 01C		116.440	I	RM 116.44	New 2017
2	25	I-25	PL 01C		119.900	D	RM 119.9	New 2017
2	25	I-25	CO 01A	15	164.200	D	Deer Creek	
2	25	I-25	NA 01C		189.510	D	F Street Hill	
2	25	I-25	NA 01A	16	207.200	D	Twenty Mile Hill	
2 & 4	25	I-25	JO 01A	17	267.300	D	I-25 Divide	
2 & 5	34	US 20/26	NA 05B	19	57.400	D	Hiland	
2	258	WY-258	NA 16Y	74	13.770	I	WYO 258	
2	34	US 20/26	NA 05A	75	30	D	Natrona	
2 & 4	42	WY 387	CL 03A	20	131.790	I	Pine Tree Jct.	
3	12	US 30	LN 03B		34	D	Sage Junction	
3	12	US 30	LN 03B		39.7	I	Nugget Canyon	
3	13	US 191	SW 04B	62	40.450	D	Farson	
3	13	US 191	SB 02D	2	127.000	D	Rim	
3	80	I-80	UI 01A		0.060	I	RM 0.06	New 2017
3	80	I-80	UI 01A	22	4.200	I	Evanston	
3	80	I-80	UI 01A		6.940	I	RM 6.94	New 2017
3	80	I-80	UI 01A	63	10.160	D	Painter Interchange	
3	80	I-80	UI 01A	23	13.860	I	First Divide	
3	80	I-80	UI 01A	64	17.660	D	US 189 Interchange	
3	80	I-80	UI 01A	65	20.950	D	Coal Road	
3	80	I-80	UI 01A	66	23.350	D	Leroy Interchange	
3	80	I-80	UI 01A	67	27.600	D	French Interchange	
3	80	I-80	UI 01B	24	52.650	D	Church Buttes	
3	80	I-80	SW 01C	1	82.310	I	Peru Hill	
3	80	I-80	SW 01D	25	90.500	D	Green River Tunnel East	
3	80	I-80	SW 01D	26	97.900	I	Rock Springs West	
3	80	I-80	SW 01G	27	111.500	D	Baxter Road	
3	80	I-80	SW 01E	28	124.500	D	Superior	
3	80	I-80	SW 01E	29	129.800	D	Point of Rocks	
3	80	I-80	SW 01E	30	141.830	I	Bitter Creek	
3	80	I-80	SW 01E	31	156.720	D	Tipton	
3	80	I-80	SW 01A	32	184.300	I	Continental Divide	
3	1906	WY 372	SW 12B	60	36.000	I	Shute Creek	
3	2000	WY 22	TE 04A	61	11.200	I	Teton Pass	

- continued next page -

Statewide RWIS sites

RWIS = remote weather information site

District	ML #	Route	Maint. Sect.	Map #	RM	DIR	Name	Under Const
4 & 2	25	I-25	JO 01A	17	267.300	D	I-25 Divide	
4 & 2	42	WY 387	CL 03A	20	131.790	I	Pine Tree Jct.	
4	43	WY 59	CL 04A	21	87.000	I	Belle Fourche	
4	90	I-90	SH 01A	52	0.100	D	MT state line	
4	90	I-90	SH 01B		35.300	I	RM 35.3	New 2017
4	90	I-90	SH 01B		41.330	D	RM 41.33	New 2017
4	90	I-90	SH 01B	53	43.700	D	Piney Creek North	(in johnson county)
4	90	I-90	JO 03B		44.700	I	Piney Creek Interchange	
4	90	I-90	JO 03B		45.330	I	RM 45.33	New 2017
4	90	I-90	JO 03B	54	83.300	I	Indian Creek Road	
4	90	I-90	JO 03B	55	91.500	D	Dead Horse	
4	90	I-90	CL 01A	56	108.000	I	RM 108	
4	90	I-90	CR 01B	57	170.510	I	Inyan Kara	
4	90	I-90	CR 01B	58	205.900	I	Beulah Interchange	
5	14	WY 28	FR 05A	3	41.400	D	South Pass	
5	14	WY 28	FR 05A	4	59.500	I	Red Canyon	
5	20	US 26	FR 02B	5	48.100	D	Beaver Rim	
5	30	US 26/287	TE 03A		26.050		Wind River Lake	
5	33	WY 120	PA 03A	18	61.500	I	Meeteetse Rim	
5 & 2	34	US 20/26	NA 05B	19	57.400	D	Hiland	
5	1507	WY 296	PA 16A	59	32.960	I	Chief Joseph	
5	36	US-16	WA 02B	73	44.01	D	Big Horn Co. Line	

Airports (AP)

	Maint.	Crew	RM	Code	Cat.	*ML#	*Route	
Dist 1	CY 99A	1034	11.220	CYS	CHEYENNE	AP	180	US 85 Bus
	MB 99A	1036	271.840	80V	MEDICINE BOW	AP	23	US 30
	DX 99A	1037	8.490	9U4	DIXON / BAGGS	AP	401	WY 70
	PB 99A	1039	401.762	82V	PINEBLUFFS	AP	1111	US 30
	LR 99A	1031	0.360	LAR	LARAMIE	AP	110	WY 14
	RW 99A	1041	215.150	RWL	RAWLINS	AP	54	I 80 Bus
	SG 99A	1042	20.920	SAA	SARATOGA	AP	22	WY 130
	HN 99A	1040	3.500	?	HANNA	AP	404	WY 72
Dist 2	CS 99A	2031	9.886	CPR	CASPER	AP	34	US 20/26
	DG 99A	2034	2.419	DGW	DOUGLAS	AP	43	WY 59
	LK 99A	2035	43.719	LSK	LUSK	AP	39	US 20
	TT 99A	2038	50.260	TOR	TORRINGTON	AP	28	US 26
	GN 99A	2039	16.032	7V6	GUERNSEY	AP	27	US 26
	WT 99A	2039	0.820	EAN	WHEATLAND	AP	1604	WY 316
	GD 99A	2034	213.176	?	GLENDO	AP	319	WY 319
Dist 3	AF 99A	3033	84.215	AFO	AFTON	AP	10	US 89
	CV 99A	3034	0.600	U06	COKEVILLE	AP	1200	WY 231
	PD 99A	3035	93.447	PNA	PINEDALE	AP	13	US 191
	ET 99A	3036	1.234	EVW	EVANSTON	AP	2112	I 80sr
	JK 99A	3039	162.840	JAC	JACKSON	AP	10	US 26/89/191
	KM 99A	3040	1.112	EMM	KEMMERER	AP	1202	WY 233
	BM 99A	3035	107.970	BPI	BIG PINEY/MARBLETON	AP	11	US 189
	FB 99A	3042	6.461	FBR	FT. BRIDGER	AP	2103	WY 412
	RS 99A	3032	4.400	RKS	ROCK SPRINGS	AP	1904	WY 370
	GR 99A	3038	5.665	?	GREEN RIVER	AP	1900	WY 530
Dist 4	BF 99A	4036	300.210	BYG	BUFFALO	AP	59	I 90 Bus
	GL 99A	4034	118.350	GCC	GILLETTE	AP	43	WY 59
	HL 99A	4039	16.156	HLT	HULETT	AP	601	WY 24
	NC 99A	4041	241.380	ECS	NEWCASTLE	AP	44	US 16
	UP 99A	4041	1.028	83V	UPTON	AP	2302	WY 116
	SD 99A	4033	1.350	SHR	SHERIDAN	AP	332	WY 332
Dist 5	GB 99A	5031	207.720	GEY	GREYBULL	AP	34	US 14/16/20
	CD 99A	5032	54.500	COD	CODY	AP	31	US 14/16/20
	PW 99A	5035	20.100	POY	POWELL	AP	1506	WY 295
	DB 99A	5033	53.415	U25	DUBOIS	AP	30	US 26/287
	LD 99A	5034	81.050	LND	LANDER	AP	20	US 26/287
	LV 99A	5035	242.760	U68	LOVELL/COWLEY	AP	34	US 14/16/20
	SS 99A	5037	100.927	49U	SHOSHONI	AP	34	US 20
	TM 99A	5040	132.830	THP	THERMOPOLIS	AP	34	US 20
	WL 99A	5041	2.590	WRL	WORLAND	AP	2201	WY 432
	RT 99A	5042	130.321	RIW	RIVERTON	AP	30	US 26/287

* note: ML and Route may be just the closest Department highway to the Airport

COUNTY MAP

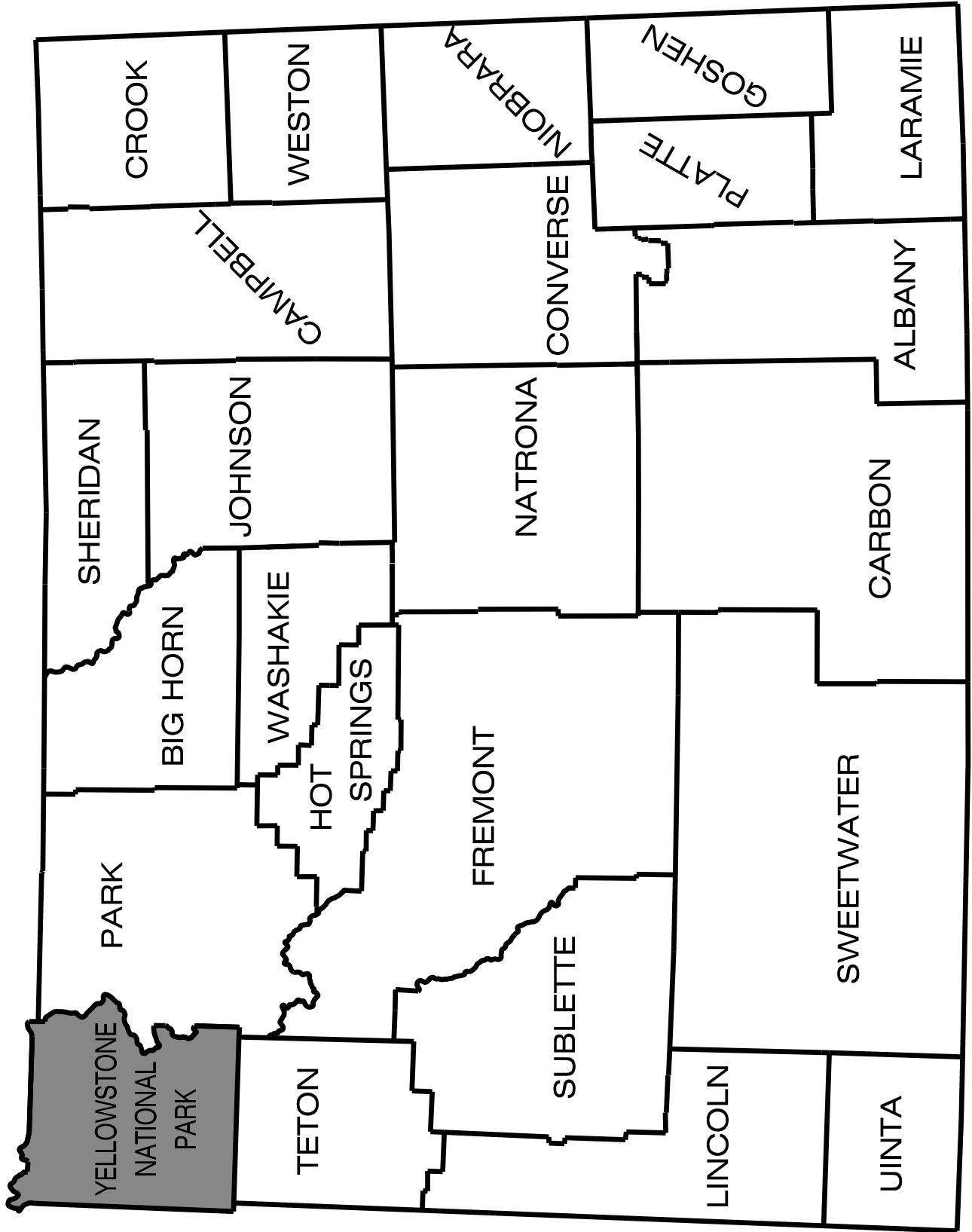

DISTRICT MAP

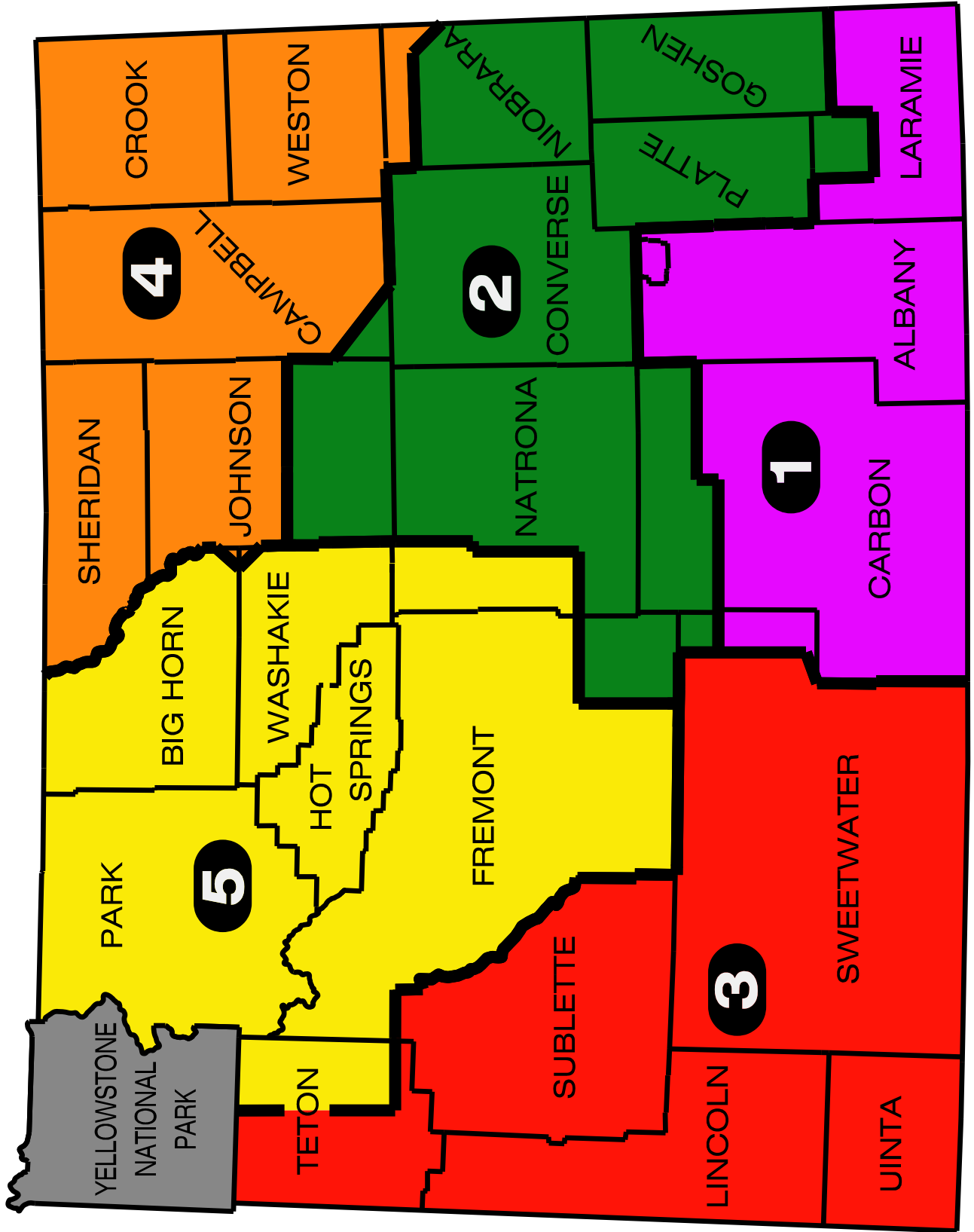

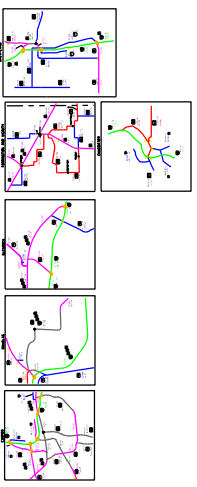
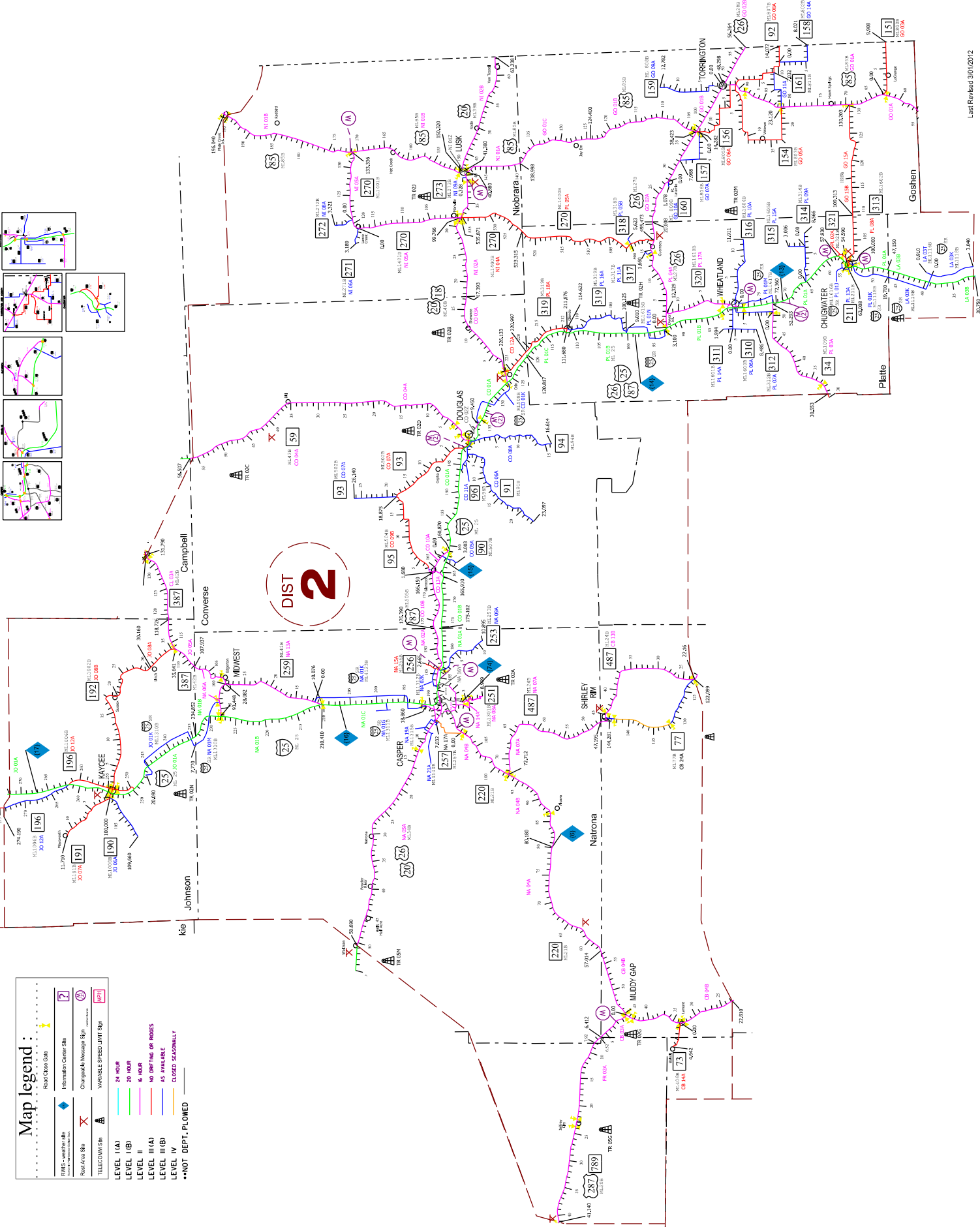

Map legend:

.....	Road Close Gate
◆	RVWS - weather site
◆	Information Center Site
◆	Changeable Message Sign
◆	TELECOMM SITE
◆	Road Area Site
◆	LEVEL I (A)
◆	LEVEL I (B)
◆	LEVEL II
◆	LEVEL III (A)
◆	LEVEL III (B)
◆	LEVEL IV
◆	NO DUMPING OR ROCKS
◆	AS AVAILABLE
◆	CLOSED SEASONALLY
◆	**NOT DEPT. PLOWED

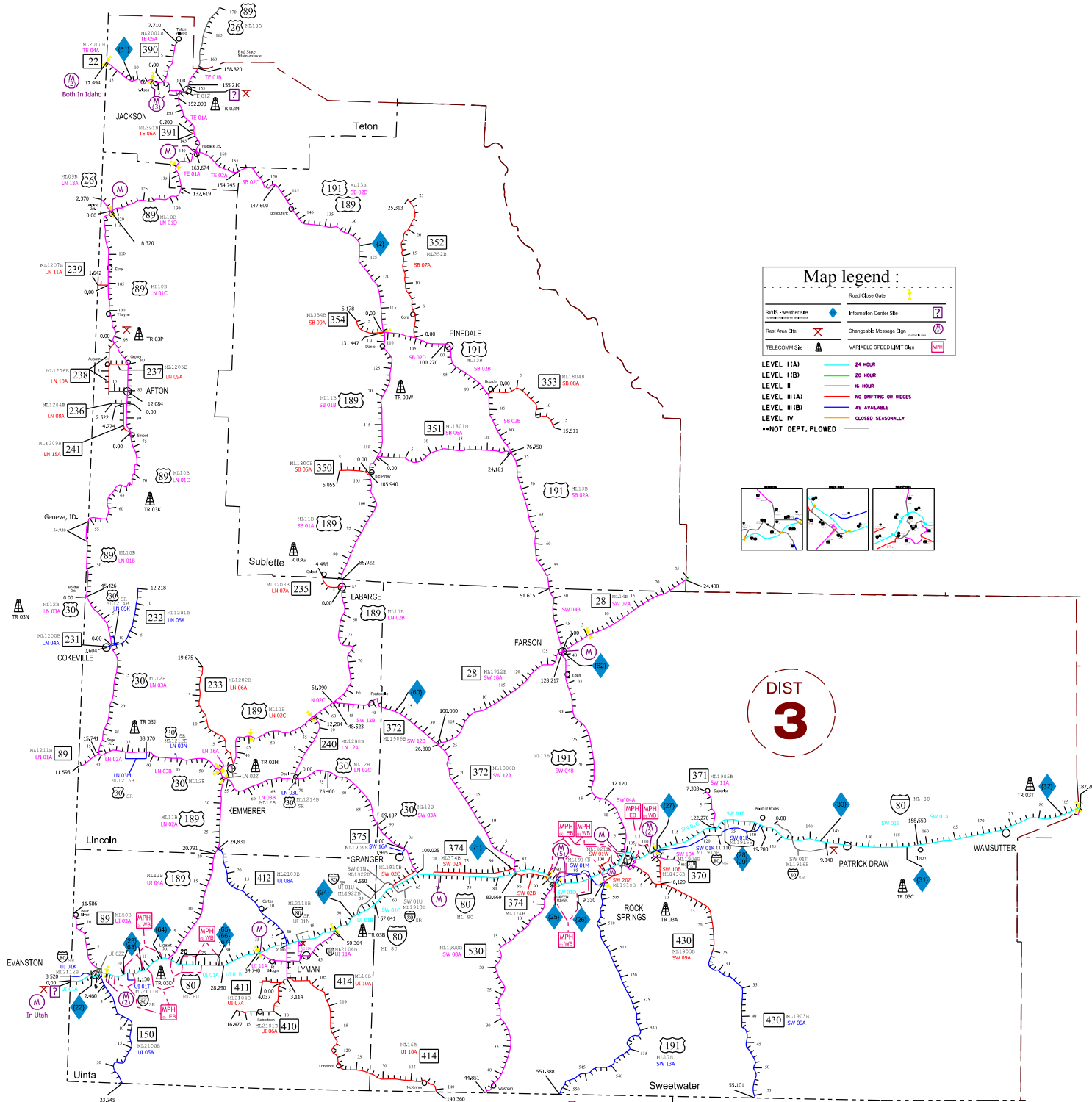

Map legend :

RWIS - weather site	Information Center Site
Rest Area Site	Changeable Message Sign
TELECOM Site	VARIABLE SPEED LIMIT Sign

- LEVEL 1(A) 24 HOUR
- LEVEL 1(B) 20 HOUR
- LEVEL II 16 HOUR
- LEVEL III (A) NO DRIVING OR HOLES
- LEVEL III (B) AS AVAILABLE
- LEVEL IV CLOSED SEASONALLY
- **NOT DEPT. PLOWED

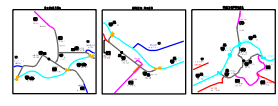

DIST
3

Last Revised 3/01/2012

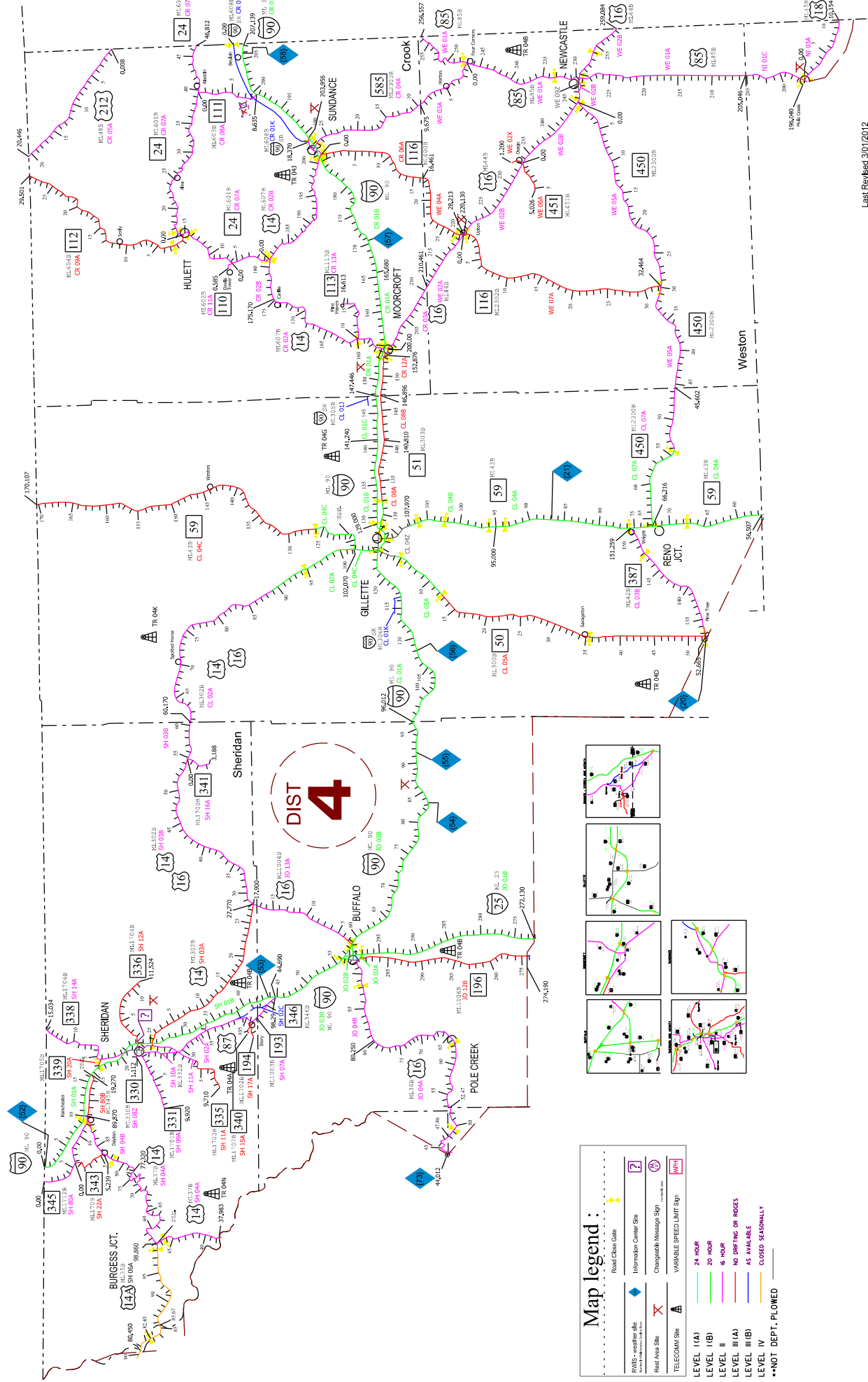

Last Revised 3/01/2012

Map legend:

	Road Closure
	Information Center Site
	Changeable Message Sign
	Weather Station
	Road Area Sign
	TELECOM Site
	VARIABLE SPEED LIMIT Sign
	LEVEL I(A)
	LEVEL I(B)
	LEVEL II
	LEVEL III(A)
	LEVEL III(B)
	LEVEL IV
	PLOWED
	NOT DEPT. PLOWED

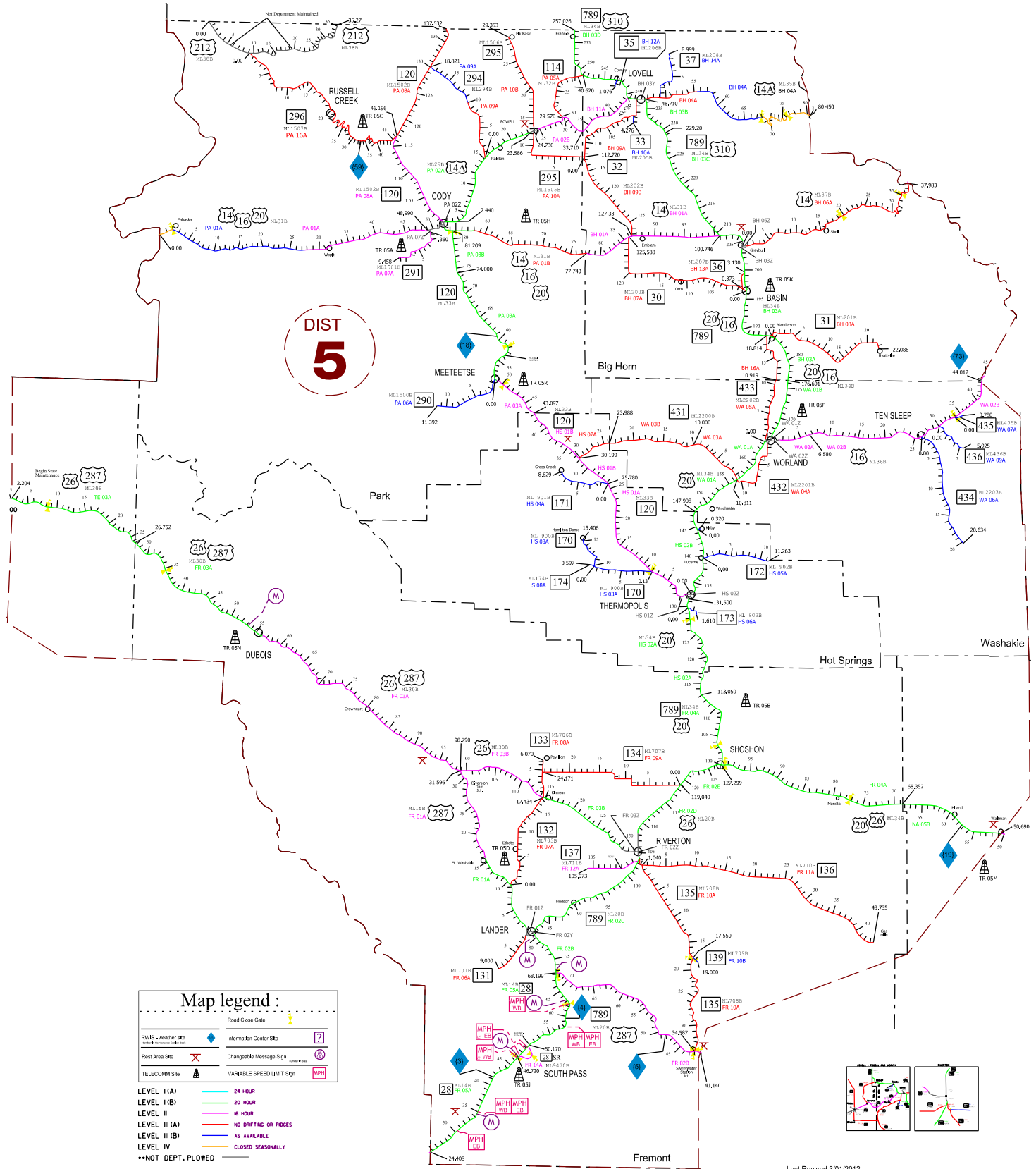

Last Revised 3/01/2012

Natrona Converse

Carbon

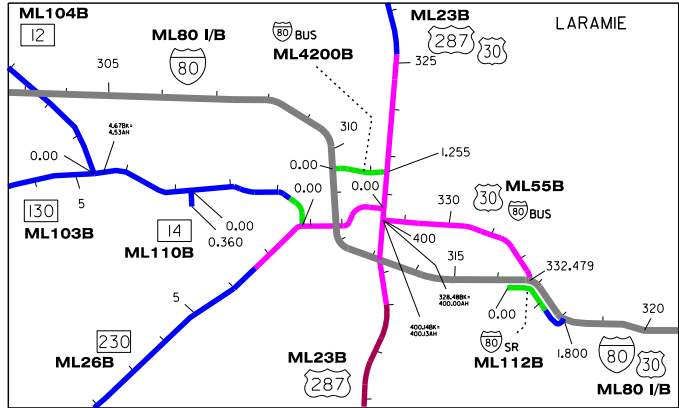
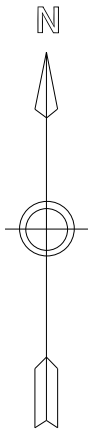

ROAD COLOR TABLE

	Rural & Urban Interstate #'s "1 & 11"
	Urban Principal Arterial Other & Expressway (NHS) #'s "12 & 14"
	Urban Minor Arterial, Collector & Local (non NHS) #'s "16, 17 & 19"
	Rural Principal Arterial Other (NHS) # "2"
	Rural Minor Arterial, Major & Minor Collectors & Local (non NHS) #'s "6, 7, 8 & 9"

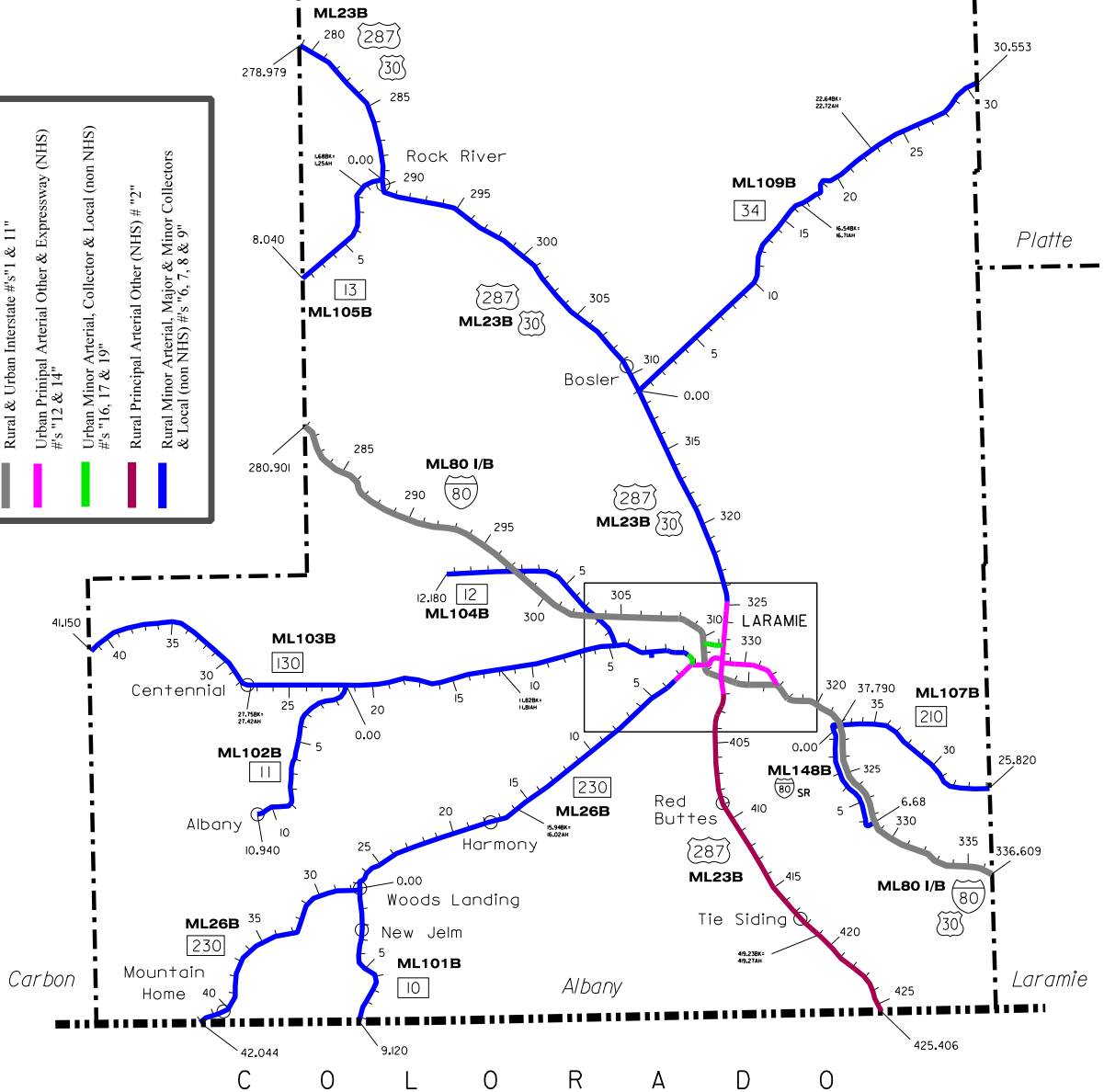

C O L O R A D O

Albany

— class "classification break"

County 5

Maint. Section	class	RM	I-80 & US 30
CREW		ML - 80	
	1	280.901	Carbon Co. Line
		282.450	Co. Rd. Sep. [AWC;EB, AWD;WB]
		283.750	Strouss Hill RWIS site {45}
AL 01A		285.088	Co. Rd. Sep. [AWE;EB, AWF;WB]
1031		285.439	Four Mile Cr. [AWG;SS]
		288.622	Machinery Pass Sep. [AWH;EB, AWI;WB]
		289.438	WB VSL sign Quealy Dome RWIS site {46}
		290.022	Bellamy & Loback Ditch [AWJ; SS]
		290.438	Quealy Dome Int. [AWK;EB, AWL;WB]
		293.888	Unnamed Draw [AWM;EB, AWN;WB]
		295.916	Unnamed Draw [AWO;EB, AWP;WB]
		297.663	WY 12 (RM 8.51); Herrick Lane Int. [AWQ;EB, AWR;WB] Herrick Lane RWIS site {47}
		297.744	Brown's Cr. [AWS;SS]
		298.108	Sand Cr. [AWT;SS]
		298.530	Poverty Draw [AWU;SS]
		298.942	Unnamed Draw [AWV;EB, AWW;WB]
		300.438	Machinery Pass. Sep. [AWX;EB, AWY;WB]
		302.910	Herrick Lane Sep. [FQI;EB, FQJ;WB]
	1	308.650	Two Rivers Rd. Sep. [AXB;EB, AXC;WB]
	—	309.910	WUL Laramie
	11	310.452	I-80 BUS (RM 0.00); Curtis St. Int. [CXZ;SS] WCL Laramie W.B. Road Close Gate R/R
		311.020	WB C.M. Sign (dynamic)
		311.160	Coalmont Br. UPRR Sep. (Under) [AXD;EB, AXE;WB]
		311.760	WY 130/230 (RM 1.32) Snowy Range Rd. Int. [KLH;EB, KLI;WB]
		312.440	Laramie Rv. [AXJ;EB, AXK;WB]
		312.923	SCL Laramie
		313.010	UPRR Sep. (Under) [LBL;EB, LBMWB]
		313.100	WCL Laramie
		313.191	US 30/287 (RM 400.93); Third St. Int. [LBN;EB, LBO;WB]
	—	313.790	Maint. Break
		313.990	15th St. Sep. [AXP]
AL 01B		314.185	ECL Laramie
1032		316.201	Moonlight Ranch Rd. Sep. [AXQ;SS]
		316.702	US 30 (RM 332.48); Grand Av. Int. [CLS;SS] Begin US 30
	11	317.200	EB C.M.Sign (dynamic)
	—	317.420	EUL Laramie

— -cont- next column

Maint. Section	class	RM	I-80 & US 30
CREW		ML - 80	
		(CONTINUED)	
	1	317.680	EB VSL sign
		317.890	E.B. Road Close Gate R/R
AL 01B		318.030	Co. Rd. Sep. [AXS;EB, AXT;WB]
1032		318.500	WB VSL sign
		319.070	Unnamed Draw [GBD;SS]
		320.987	Medicine Bow Nat'l. Forest Boundary
		322.600	WB C.M.Sign (dynamic) WB VSL sign
		323.049	WY 210 (RM 37.792) [BLJ;SS] Happy Jack Summit Int. Summit Rest Area AL 01R WB C.M.Sign (dynamic)
		323.850	EB VSL sign
		324.900	EB C.M.Sign (dynamic)
		325.780	WB VSL sign
		325.820	EB VSL sign
		325.900	Summit RWIS site {48}
		326.250	EB C.M.Sign (dynamic)
		326.600	Blair Rd. Sep. [AXU;EB, AXV;WB]
		326.821	Medicine Bow Nat'l. Forest Boundary
		328.740	WB VSL sign
		328.820	EB C.M.Sign (dynamic)
		329.201	Medicine Bow Nat'l. Forest Boundary
		329.316	Vedauwoo Int. [AXW;EB, AXX;WB]
		329.370	Vedauwoo RWIS site {49}
		329.880	EB VSL sign
		330.633	Medicine Bow Nat'l. Forest Boundary
		331.290	WB C.M.Sign (dynamic)
		332.290	WB VSL sign
		333.320	EB VSL sign Lone Tree RWIS site {68}
		334.300	WB VSL sign
		334.500	WB C.M.Sign (dynamic)
		335.106	Buford Int. [AXZ;EB, AYA;WB]
		336.100	WB C.M.Sign (dynamic)
		336.160	EB VSL sign
		336.500	Buford East RWIS site {69}
	1	336.609	Laramie Co. Line

Maint. Section	class	RM	US 287, US 30 & I-80 BUS
		ML - 23B	
AL 02A	6	278.979	Carbon Co. Line
		288.974	WY 13 (RM 0.00)
1036		289.221	NCL Rock River
		290.509	Rock Cr. [KTW;SS]
		290.749	SCL Rock River
		292.468	Begin 4-Lane
AL 02B		308.712	End 4-Lane
1031		309.066	Bosler
		310.661	Laramie Rv. [CJC;SS]
		310.710	N.B. Road Close Gate R/R
		310.847	WY 34 (RM 0.00)
		311.367	Boughton Canal
		313.010	UPRR Sep. (Under)
		313.892	Floodwater Cr. [CJE;SS]
	6	320.500	N.B. Road Close Gate R/R
		325.250	NUL Laramie
	14		Begin 5 -Lane
		326.000	NB C.M.Sign (dynamic)
		327.315	NCL Laramie
		327.372	I-80 BUS (RM 1.26); N. Laramie Conn. Begin I-80 Bus.
		328.219	WY 130/230 (RM 0.00)
		328.481	US 30 & I-80 BUS. (RM 328.48) End US 30 & I-80 Bus.
AL 02Z			BK= -72.519 mi
1032		400.000	AH Equation
		400.777	Spring Cr. [BUU;SS]
		400.936	I-80 (RM 313.19); Third St. Int. [LBN;EB, LBO;WB], Begin NHS
		401.259	UPRR Sep. (Under) [LIS;SS]
		401.960	Dept. Shop - Laramie DH 01A Laramie Port-of-Entry AL 02P
		402.317	SCL Laramie
	14	403.900	S.B. Road Close Gate R/R
		404.400	SUL Laramie
AL 02C	2	409.581	Harney Cr. [BUX;SS]
1032		413.253	UPRR Sep. (Under) [BUY;SS]
		417.366	Tie Siding
		419.230	BK= - 0.04 mi.
		419.270	AH Equation
		420.360	Pumpkin Vine RWIS site {8}
	2	425.406	Colorado State Line End WY NHS

Maint. Section	class	RM	US 30 & I-80 Bus.
		ML - 55B	
AL 03Z	14	328.481	US 30/287 (RM 328.48)
		1032	330.638 Spring Cr. [DLN;SS]
			331.444 ECL Laramie
AL 03A		332.180	Oriole lane
		1032	332.204 Begin Divided Section
	14	332.480	I-80 (RM 316.70); Grand Ave. Int. [CLS;SS]
I-80 Bus.			
<i>North Laramie Connector</i>			
		ML - 4200B	
	16	0.000	I-80 (RM 310.45); Curtis St. Int.
AL 13A		0.332	CL Laramie
		1031	0.447 Laramie Rv. [CXY;SS]
			1.043 UPRR Sep. (Under) [BLB;SS]
			1.255 US 30/287 (RM 327.37)
WY 10			
		ML - 101B	
	7	0.000	WY 230 (RM 27.30) Woods Landing
AL 06A		0.780	Laramie Rv. [LIL;SS]
		1032	3.200 Jelm Mountain Rd
			8.200 Mountain Home Rd
			9.117 Colorado State Line
WY 11			
		ML - 102B	
	7	0.000	WY 130 (RM 21.62)
AL 07A		3.200	Dinwiddie Rd
		1031	10.935 Albany / End SHS
WY 12			
		ML - 104B	
	7	0.000	WY 130 (RM 4.70)
AL 09A		2.634	Herrick Lane Sep.
		1031	7.570 Flood Channel [CIS;SS]
			8.070 Little Laramie Rv. [CIT;SS]
			8.152 I-80 (RM 297.66); Herrick Ln. Int. [AWQ;EB, AWR;WB]
			10.180 W. Fork Little Laramie Rv. [CIU;SS]
			12.182 End SHS
WY 13			
		ML - 105B	
	7	0.000	US 30/287 (RM 288.97)
AL 10A		0.321	UPRR Sep. (Under) [EUQ;SS]
		1038	1.676 BK= + 0.431 mi.
			1.245 AH Equation
			2.360 Rock Creek [CIV;SS]
			8.035 Carbon County Line

Maint. Section	class	RM	WY 34
			ML - 109B
AL 04A	6	0.000	US 30/287 (RM 310.85)
1031		0.020	E.B. Road Close Gate R/R
		10.660	Sybille Rd (east)
		25.680	BK= - 0.037 mi.
		25.717	AH Equation
			North Sybille Cr. [DJU;SS]
		27.300	Sybille Rd (south)
		28.367	BK= - 0.013 mi.
		28.380	AH Equation
		30.553	Platte County line
			District Boundary

WY 130 & 230			
Maint. Section	class	RM	WY 130 & 230
			ML - 26B
AL 05Z	14	0.000	US 30/287 (RM 328.22)
1032		0.180	Clark Street Viaduct UPRR Sep. (Under) [CIF;SS]
		0.420	RR at Grade Crossing #810692D
		0.661	Big Laramie River [DCZ;SS]
		1.320	I-80 (RM 311.76); Snowy Range Rd. Int. [KLH;EB, KLI;WB]
		1.470	Pierce street
		2.120	WY 130 (RM 0.00) End WY 130
	14	2.432	WCL Laramie
		3.450	WUL Laramie
AL 05A	6	9.970	Harmony Rd (west)
1032		15.940	BK= - 0.08 mi.
		16.020	AH Equation
		17.750	Harmony Rd (north)
		22.341	Pioneer Canal [CIH;SS]
		26.300	Fox Cr. [CI;SS]
		26.540	Fox Cr. Rd
		27.340	WY 10 (RM 0.00) Woods Landing
		28.481	Medicine Bow Nat'l. Forest Boundary
		35.700	Fox Park Rd
		40.100	Mountain Home Rd
		41.280	Forest Rd Sep. (Under) [FND;SS]
	6	42.040	Colorado State Line

Maint. Section	class	RM	WY 130
			ML - 103B
AL 08Z		0.000	WY 130/230 (RM 2.10)
1031	16		
		0.733	WCL & WUL Laramie
	7	2.779	WY 14 (RM 0.00); Airport spur
AL 08A			W.B. Road Close Gate swing
1031		4.668	BK= + 0.137 mi.
		4.531	AH Equation
		4.702	WY 12 (RM 0.00)
		11.823	BK= + 0.011 mi.
		11.812	AH Equation
		13.150	Big Hollow Rd (south)
		13.300	Mandel Lane (north)
		19.945	Lake Hattie Canal [CIL;SS]
		21.621	WY 11 (RM 0.00)
		22.037	Little Laramie Rv. [DJN;SS]
		26.600	Dinwiddie Rd (south)
		26.759	N. Fork Little Laramie Rv. [DJM;SS]
		27.752	BK= + 0.33 mi.
		27.422	AH Equation at Centennial
		28.713	Medicine Bow Nat'l. Forest Boundary
		30.590	N. Fork Little Laramie Rv. [DDJ;SS]
		33.960	W.B. Road Close No barricades
		34.500	W.B. Road Close barricades
		35.146	Brooklyn Lake Rd
		35.810	W.B. Road Close Gate swing <i>Seasonal Closure</i>
	7	41.150	Carbon County Line

WY 210			
Maint. Section	class	RM	WY 210
			ML - 107B
AL 11A	7	25.815	Laramie County Line
1032		26.445	Medicine Bow Nat'l. Forest Boundary
		33.681	S.F. Lodgepole Cr. [FDX;SS]
		35.670	Happy Jack Rec. Area
		37.700	E.B. Road Close Gate swing
		37.792	I-80 (RM 323.049); Summit Int. [BLJ;SS]

I-80 SV. RD.			
Maint. Section	class	RM	I-80 SV. RD.
			ML - 148B
AL 01J	9	0.000	Jct. Happy Jack Rd. Int. WY 210(RM 37.79)
1032		6.680	End Sv. Rd. @Jct. Vedauwoo Rd. Int.

I-80 SV. RD.			
Maint. Section	class	RM	I-80 SV. RD.
			ML - 112B
	17	0.000	Jct. Moonlight Rd Sep. [AXQ]
AL 01K	17	1.230	EUL Laramie
1032		1.280	Urban Break
	9	1.800	End Sv. Rd. @Co. Rd. Sep. [ASX;EB]

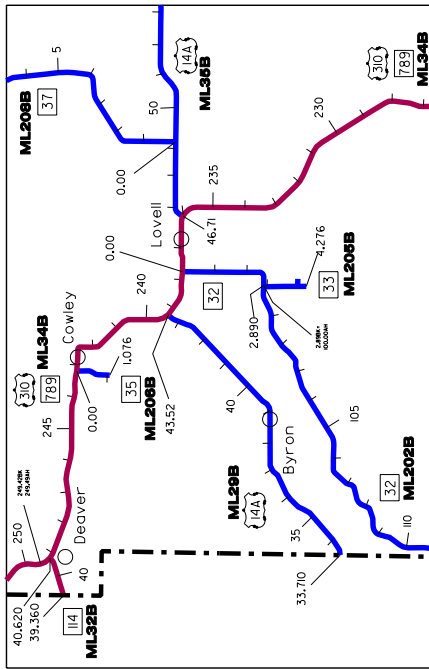

ROAD COLOR TABLE

- █ Rural & Urban Interstate #s "1 & 11"
- █ Urban Principal Arterial Other & Expressway (NHS) #s "12 & 14"
- █ Urban Minor Arterial, Collector & Local (non NHS) #s "16, 17 & 19"
- █ Rural Principal Arterial Other (NHS) # "2"
- █ Rural Minor Arterial, Major & Minor Collectors & Local (non NHS) #s "6, 7, 8 & 9"

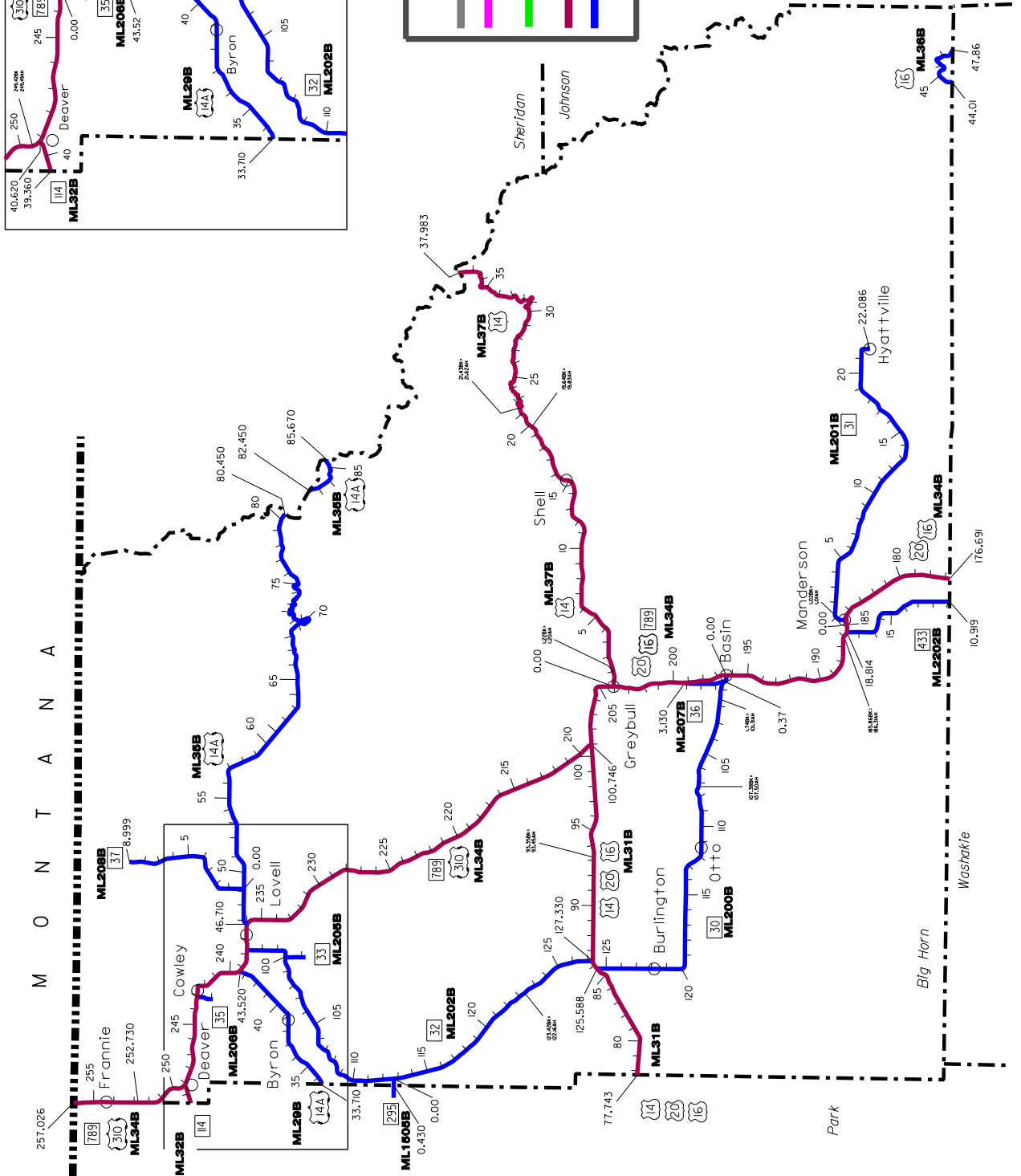
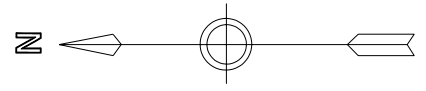

Big Horn

— class "classification break"

County 9

Maint. Section	class	RM	US 14, 16 & 20
ML - 31B			
	2	77.743	Park Co. Line Cont. NHS
BH 01A		85.655	WY 30 (RM 125.59)
5031		86.264	WY 32 (RM 127.33)
		87.360	Emblem
		93.353	BK= - 0.95 mi.
		93.448	AH Equation
		93.960	County Rd (south)
		94.064	Dry Cr.[CAC;SS]
		100.746	US 310 (RM 209.03)
US 14, 16, 20, 310 & WY 789			
ML - 34B			
	2	176.691	Washakie County Line Cont. NHS
BH 03A		178.190	Rairden Rd
5031		184.203	ECL Manderson
		184.346	WY 31 East Mainline (RM 0.00)
		184.556	BNRR Sep. (Under) [DIQ;SS]
		184.950	WY 31 West Spur (RM 0.00)
		185.038	WCL Manderson
		185.052	Big Horn Rv. [DIV;SS]
		185.517	WY 433 (RM 18.81)
		185.862	BK= - 0.448 mi.
		186.310	AH Equation, Cont. NHS
		187.770	Orchard Bench Rd (south)
		188.056	Dobie Cr. [CCR;SS]
		188.723	Big Horn Canal [BSL;SS]
		191.147	Elk Cr. [JBY;SS]
		191.659	Big Horn Canal [HNP;SS]
		194.660	Antelope Cr. [CCU;SS]
		194.970	Orchard Bench Rd (north)
		195.741	SCL Basin
		196.415	WY 30 (RM 0.00)
			Dept. Shop - Basin DH 05A
			1 Blk. East on "C" St.
		196.720	NCL Basin
		197.175	ECL Basin
		197.330	NCL Basin
		199.270	WY 36 (RM 3.13)
		202.770	Greybull Rv. [CCV;SS]
		203.566	BNRR Sep. (Under) [LCY;SS]
		203.633	SCL Greybull
BH 03Z	2	204.054	US 14 (RM 0.00)
5031			Begin US 14 & US 310
		205.062	NCL Greybull

→ -cont- next column

Maint. Section	class	RM	US 14, 16, 20, 310 & WY 789
ML - 34B			
-cont-			<i>(CONTINUED)</i>
		205.062	NCL Greybull
	2	205.287	Dry Cr. [CCX;SS]
BH 03C		205.506	BNRR Sep. (Under) [CCY;SS]
5031		205.720	County Rd (north)
		206.700	Airport Rest Area BH 03R
		207.720	Airport Rd
		209.033	US 14,16,20 (RM 100.75)
			End US 14, 16 & 20
		211.654	Little Dry Cr. [CCZ;SS]
		228.820	East fork Sand Draw [HOI;SS]
		229.200	Maint. Break
	2	234.830	County Rd (north)
BH 03B		235.830	County Rd (east & west)
5035		236.060	US 14A (RM 0.00)
			Begin US 14A,
			Dept. Shop - Lovell LV 05A
			Approx. 2 Blks. S. on McKinley Av.
			Cont. NHS
		236.260	ECL Lovell, Cont. NHS
BH 03Y	2	236.357	Begin Divided Section
5035			
		237.286	WCL Lovell
	2	237.415	End Divided Section
BH 03D		237.797	WY 32 (RM 0.00)
5035		238.778	Shoshone Rv. [BSO;SS]
		239.259	US 14A (RM 43.52)
			End US 14A
		239.630	Sage Cr. [CDB;SS]
		239.758	BNRR Sep. [CDC;SS]
		242.409	ECL Cowley
		242.480	Begin Divided Section
		242.965	End Divided Section
		243.187	WCL Cowley,
			WY 35 (RM 0.00)
		245.390	County Rd (north)
		246.661	Sidon Canal [CYU;SS]
		247.074	Sage Cr. [CDD;SS]
		248.533	ECL Deaver
		249.167	WY 114 (RM 40.62)
		249.346	NCL Deaver
		249.420	BK= - 0.07 mi.
		249.490	AH Equation
		252.727	Park County Line
			Cont. NHS

→ -cont- in Park County

Maint. Section	class	RM	US 14A
BH 04A	6		ML - 35B
5035		46.710	US 14,16,20 (RM 236.06)
		48.110	Sand Draw [DBQ;SS]
		49.170	WY 37 (RM 0.00)
		54.700	Big Horn Nat'l. Recreation Boundary
		55.430	RR at Grade Crossing #091517A
		55.760	County Rd (south)
		56.890	Yellowtail Reservoir [CDN;SS]
		58.790	E. Boundary Big Horn Nat'l. Recreation Area
		68.730	E.B. Road Close Gate R/R <i>Seasonal Closure (local traffic)</i>
		70.790	WB Truck Run-away Ramp
		71.720	Big Horn Nat'l. Forest Boundary
		71.980	Big Horn Nat'l. Forest Boundary
		72.090	Big Horn Nat'l. Forest Boundary
		72.100	WB Truck Run-away Ramp
		73.080	Big Horn Nat'l. Forest Boundary
		73.360	Big Horn Nat'l. Forest Boundary
		73.600	Big Horn Nat'l. Forest Boundary
		73.760	Big Horn Nat'l. Forest Boundary
		76.350	WB Truck Run-away Ramp
		76.400	E.B. Road Close Gate swing <i>Seasonal Closure</i>
		80.450	Big Horn Co. line / District Boundary
SH 06A	6	82.450	Sheridan Co. line
4038		85.670	Big Horn Co. Line

-cont- in Sheridan County

Maint. Section	class	RM	US 14A
BH 11A	6		ML - 29B
5035		33.710	Park County Line
		34.330	Sidon Canal [EUP;SS]
		36.170	Sidon Canal [EWI;SS]
		36.460	Sidon Canal [EWJ;SS]
		38.030	Begin Divided Section
		38.280	WCL Byron
		39.360	ECL Byron
		39.390	End Divided Section
		43.520	US 310 (RM 239.259)

Maint. Section	class	RM	US 14
BH 06Z	2		ML - 37B
5031		0.000	US 14,16,20 (RM 204.05)
			Begin NHS
		0.415	Big Horn Rv. [FEV;SS]
			ECL Greybull
BH 06A	2	1.215	BK= + 0.016 mi.
5031		1.199	AH Equation
		2.120	County Rd (north)
		4.925	Alkali Draw [LJE;SS]
		5.886	Potato Draw [LJF;SS]
		12.248	Red Gulch [CEG;SS]
		15.300	Shell Canal
		15.340	Shell
		15.390	Spring Branch Cr.
		15.880	Shell Cr. [FSA;SS]
		19.630	Shell Cr. [FSB;SS]
			E.B. Road Close Gate R/R
		19.636	BK = -.189 mi.
		19.825	AH Equation
		20.359	Big Horn Nat'l. Forest Boundary
		21.430	BK= - 0.192 mi.
		21.622	AH Equation
		26.711	Shell Cr. [CEL;SS]
		27.100	WB Truck Run-away Ramp
		31.760	Hyattville Rd
		35.070	E.B. Road Close Gate R/R
		37.983	Sheridan Co. Line / District Boundary
			Cont. NHS

Maint. Section	class	RM	US 16
JO 04A	2		ML - 36B
4037		44.012	Washakie County Line
		47.087	East Ten Sleep Cr. [EWU;SS]
		47.860	Washakie County Line

-cont- in Big Horn County

Maint. Section	class	RM	WY 30
BH 07A	7		ML - 200B
5031		0.000	US 16,20 (RM 196.42)
		0.370	WY 36 (RM 0.37)
		0.650	WCL Basin
		1.743	BK= - 99.07 mi.
		101.312	AH Equation
		107.216	Greybull Rv. [KTS;SS]
		107.360	Greybull River Rd
		107.378	BK= - 0.122 mi.
		107.500	AH Equation
		108.845	McKenney Draw [CJD;SS]
		111.799	Otto
		119.700	Meeteetse Rd
		121.250	Burlington SCL
		122.250	Burlington NCL
		125.588	US 14,16,20 (RM 85.66)

Maint. Section	class	RM	WY 31
BH 08A	7	0.000	US 16,20 (RM 184.35)
5031		0.424	WY 31 Spur (RM 0.31)
		0.930	NCL Manderson
		1.019	Nowood Rv. [BLN;SS] BK= + 0.01 mi.
		1.010	AH Equation
		5.492	Nowood Rv. [CJF;SS]
		6.500	County Rd (south)
		13.635	Nowood Rv. [CJG;SS]
		14.740	County Rd (south)
		19.383	Alkali Cr. [CJH;SS]
		21.890	Medicine Lodge Cr. [CJI;SS]
		22.086	Hyattville End SHS

Maint. Section	class	RM	WY 31
BH 08B	7	0.000	US 16,20 (RM 184.95)
5031		0.270	BNRR at Grade Crossing #090842T
		0.310	WY 31 (RM 0.42); Mainline Manderson

Maint. Section	class	RM	WY 32
BH 09A	7	0.000	US 310 (RM 237.80)
5035		2.888	BK= - 97.11 mi.
		100.000	AH Equation WY 33 (RM 2.89)
		100.486	Foster Gulch [CJJ;SS]
		104.280	Sand Cr. [CUD;SS]
		105.260	Coon Cr. [CJL;SS]
		107.530	Whistle Cr. [CJM;SS]
		110.570	Lovell Canal [CJN;SS]
		112.719	WY 295 (RM 0.00)
BH 09B	7	115.720	Whistle Cr. [EAD;SS]
5031		119.500	Unnamed Draw [CJP;SS]
		123.415	BK= + 1.252 mi.
		122.163	AH Equation
		126.678	Dry. Cr. [CJQ;SS]
		127.326	US 14,16,20 (RM 86.26)

Maint. Section	class	RM	WY 33
BH 10A	8	2.888	WY 32 (RM100.00)
5035		4.276	End SHS

Maint. Section	class	RM	WY 35
BH 12A	9	0.000	US 310 (RM 243.187)
5035		0.715	Sage Cr. [CJW;SS]
		1.076	End SHS

Maint. Section	class	RM	WY 36
BH 13A	9	0.370	WY 30 (RM 0.37)
5031		1.230	NCL Basin
		3.130	US 16,20 (RM 199.270)

Maint. Section	class	RM	WY 37
BH 14A	7	0.000	US 14A (RM 2.45)
5035		0.900	RR at Grade Crossing #091508B
		1.235	Shoshone Rv. [CJX;SS]
		1.650	County Rd (west)
		7.397	Big Horn Nat'l. Rec. Area Bndry
		8.999	End SHS

Maint. Section	class	RM	WY 114
PA 05A	2	39.355	Park County Line Cont. NHS
5035		40.140	WCL Deaver
		40.570	RR at Grade Crossing #091482B
		40.621	US 310 (RM 249.167)
			End NHS

Maint. Section	class	RM	WY 295
PA 10A	7	0.000	WY 32 (RM 112.72)
5035		0.432	Park County Line

→ -cont- in Park County

Maint. Section	class	RM	WY 433
BH 16A	7	10.919	Washakie County Line
5041		11.270	Five Mile Cr. [CXK;SS]
		12.420	Rairden Rd
		18.814	US 14,16,20 (RM 185.52)

ROAD COLOR TABLE

- Rural & Urban Interstate #'s "1 & 11"
- Urban Principal Arterial Other & Expressway (NHS) #'s "12 & 14"
- Urban Minor Arterial, Collector & Local (non NHS) #'s "16, 17 & 19"
- Rural Principal Arterial Other (NHS) # "2"
- Rural Minor Arterial, Major & Minor Collectors & Local (non NHS) #'s "6, 7, 8 & 9"

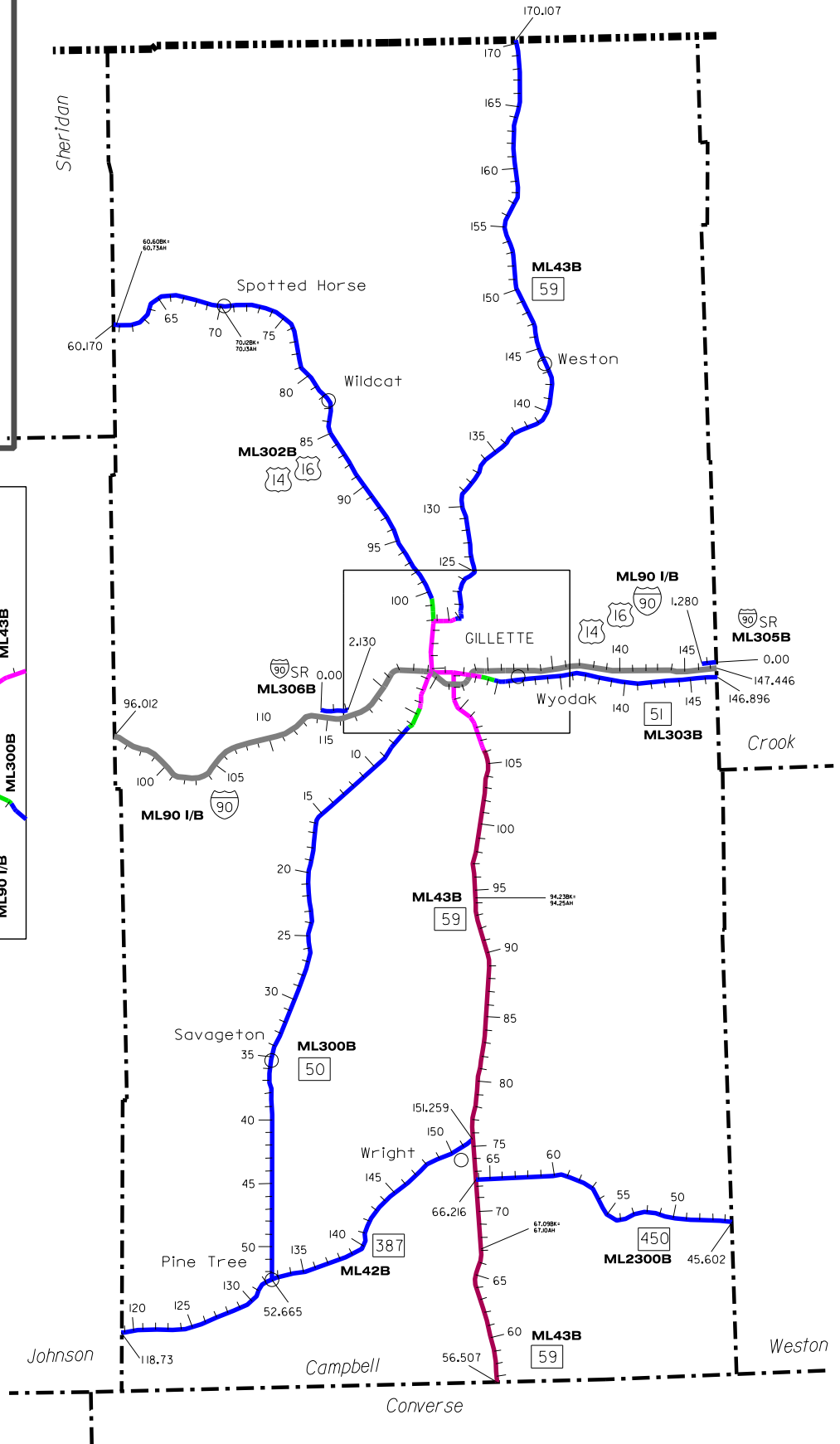
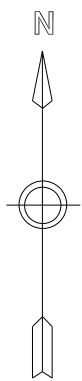
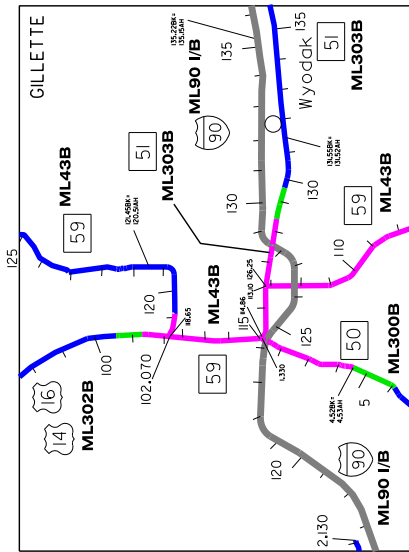

Campbell

class "classification break"

County 17

Maint.	Section	class	RM	I-90 & US 14/16
				ML - 90
		1	96.012	Johnson Co. Line
			98.332	Machinery Pass Sep. [BFB;EB, BFC;WB]
			102.521	Barber Cr. Int. [BFD;EB, BFE;WB]
			106.139	Kingsbury Rd. Int. [BFF;EB, BFG;WB]
			108.000	West Gillette RWIS site {56}
CL 01A			111.907	Lowery Sep. [BFH;EB, BFI;WB]
4035			112.721	W. Fork Wild Horse Cr. [BFJ;EB, BFK;WB]
			113.259	E. Fork Wild Horse Cr. [BFL;EB, BFM;WB]
			113.967	Wild Horse Cr. Rd. Int. [BFN;EB, BFO;WB]
			116.237	Force Rd. Int. [BFP;EB, BFQ;WB]
			117.230	Co. Rd. Sep. [BFR;EB, BFS;WB]
		1	120.041	Machinery Pass Sep. [BFT;EB, BFU;WB]
		●	121.270	WUL Gillette
		11	122.065	Machinery Pass Sep. [BFV;EB, BFW;WB]
			122.740	EB C.M.Sign (dynamic) WB C.M.Sign (dynamic)
			124.027	WCL Gillette
			124.264	US 14/16, WY 50, I-90 BUS; West Gillette Int. (RM 114.86) [BFX;EB, BFY;WB]
			124.300	W.B. Road Close Gate R/R
			124.880	Burma Rd. Overpass [MCO;SS]
			125.570	Savageton Rd. Overpass [CRA;EB, CSC;WB]
			126.390	WY 59; WY 59 Int. (RM 112.16) [CYK;EB, CYL;WB]
			127.140	Co. Rd. Int. [CYM;EB, CYN;WB]
			127.670	Stone Pile Cr. [CYO;SS]
			128.090	US 14/16; East Gillette Int. (RM 127.57) BNRR (Under) [DAI;SS] ECL Gillette Begin US 14 & 16
			129.104	Garner Lake Rd. Int. [FIT;SS] Dept. Shop Gillette GL 04A north on Garner Lake Rd. E.B. Road Close Gate R/R
			130.254	Coal Rd Overpass [DAK;EB, DAL;WB]
			130.330	EB C.M.Sign (dynamic) WB C.M.Sign (dynamic)
		11	130.350	EUL Gillette
		●		
		1	132.385	Wyodak Coal Rd. Overpass [CDK;EB, CDL;WB]
CL 01B			132.991	Wyodak Int. [CDM;SS]
4035			134.435	Machinery Pass Sep. [CFG;EB, CFW;WB]
			135.235	BK= + 0.087 mi.
			135.148	AH Equation
			135.413	BNRR Sep. (Under) [DAT;EB, DAU;WB]
			135.749	Unnamed Draw [DBC;SS]

Maint.	Section	class	RM	I-90 & US 14/16
				ML - 90
				<i>(CONTINUED)</i>
			139.298	Co. Rd. Sep. [DBD;SS]
		1	141.129	Unnamed Draw [DAZ;SS]
		→	141.237	Rozet Int. [DBG;SS] [DBA;EBR, DBB;WBR]
		1	142.265	Machinery Pass Sep.[DAV;EB, DAW;WB]
CL 01C			144.357	Co. Rd. Overpass [DBT;EB, DBU;WB]
4040			146.710	Gray Rd. Overpass [BGG;EB, BGH;WB]
		1	147.450	Crook Co. Line
				US 14, 16, WY 59 & I-90 Bus.
				ML - 43B
		2	56.507	Converse Co. Line / District Boundary
			57.183	Spring Cr. [DIR;SS]
CL 04A			67.490	Edwards Rd (east)
4043			67.500	S.B. Road Close Gate R/R
			71.990	Dept. Shop - Reno Jct. RJ 04A
			72.393	WY 450 (RM 66.22)
			74.927	SCL of Wright
			75.064	WY 387 (RM 151.26)
			75.192	NCL of Wright
			75.800	N.B. Road Close Gate R/R
			77.370	East Fork Hay Cr. [DCF;SS]
			79.959	Hay Cr. [DCG;SS]
			80.361	Dry Cr. [DCH;SS]
			81.400	Breen Rd
			82.098	Unnamed Draw [DCI;SS]
			86.990	Belle Fourche RWIS site {21}
			87.059	Belle Fourche Rv. [FBP;SS]
			93.746	Haight Rd (east)
			93.700	S.B. Road Close Gate R/R
			94.232	BK= - 0.013 mi.
			94.245	AH Equation
		→	95.000	Maint.Crew Break
			96.000	S.B. Road Close Gate R/R
			97.430	Caballo Cr. [CXP;SS]
CL 04B			97.740	Hoe Creek Rd
4035			98.323	Bone Pile Cr. [CGQ;SS]
			102.400	S.B. Road Close Gate R/R
			102.839	Tisdale Cr. [MFU;SS]
			103.410	Mine Rd
		2	105.500	S.B. Road Close Gate R/R
		●	106.683	SUL Gillette
		→	107.970	Union Chapel Rd
CL 04Z			109.176	Antelope Cr. [CBH;SS]
4035			109.720	Southern Drive
		14	110.600	SCL Gillette

→ -cont- next page

Maint. Section	class	RM	US 14, 16, WY 59 & I-90 Bus.
CREW		ML - 43B	
-cont-		<i>(CONTINUED)</i>	
CL 04Z	14	111.272	Donkey Cr. [CBJ;SS]
		111.440	Lakeway Rd
		111.603	Homestead Trickle [MBF;SS]
4035		112.160	I-90; WY 59 Int. (RM 126.39) [CYK;EB, CYL;WB]
		113.054	WY 51 (RM 126.25)
		113.950	Rohan Ave.
		114.855	WY 50 (RM 1.33) Begin US 14 & 16
		114.965	Stone Pile Cr. [DEH;SS]
		115.038	BNRR Sep. (Over) [DIB]
		115.412	NCL Gillette Maint. Crew Break
CL 04C		117.860	Hannum Rd
4035	14	118.350	Little Powder River Rd. [GDP;SS]

WY 59			
ML - 46B			
	6	119.240	US 14/16 Int.
		123.872	BNRR Sep. (Under) [DIJ;SS]
		124.000	Dry Fork Creek [GFX;SS]
		125.210	Burlington Supply Ditch [CSH;SS]
CL 04C		125.580	Dry Fork [HVK;SS]
4035		126.090	N.B. Road Close Gate R/R
		126.609	Little Powder Rv. [KNX;SS]
		130.235	Corral Cr. [KNY;SS]
		132.787	Cedar Cr.
		135.600	Cow Creek Rd (east)
		136.250	Little Powder Rv. [LWT;SS]
		142.468	Coal Creek [CHE;SS]
		143.890	Weston
		144.201	Unnamed Draw [CHF;SS]
		149.020	Pine Tree Draw [CHG;SS]
		150.889	Horse Cr. [CHH;SS]
		153.032	White Tail Cr. [CHI;SS]
		155.390	Recluse Rd
		155.632	Elk Cr. [CHJ;SS]
		157.835	Unnamed Draw [CHK;SS]
		164.435	Olmstead Cr. [CHL;SS]
		166.717	Unnamed Draw [BLD;SS]
	6	170.107	Montana State Line

Maint. Section	class	RM	US 14 & 16
CREW		ML - 302B	
	7	60.170	Sheridan Co. Line
		60.596	BK= - 0.129 mi.
		60.725	AH Equation
		69.578	Spotted Horse Cr. [DCK;SS]
		70.121	BK= - 0.012 mi.
CL 02A		70.133	AH Equation
4035		70.200	Spotted Horse
		75.877	Recluse Rd
		80.041	Horse Cr. [EOH;SS]
		85.653	North Wildcat Cr. [EOG;SS]
		88.029	South Wildcat Cr. [CLF;SS]
		93.800	Collins Rd (northeast)
		95.350	W.B. Road Close Gate R/R
		96.137	Rawhide Cr. [CLH;SS]
		98.313	Wyo 59 Int.
		99.432	BK= + 0.03 mi.
		99.402	AH Equation
	7	99.710	Little Rawhide Cr. [MFJ;SS]
		100.400	Haul Road Bridge [MFH;SS]
		100.768	NUL Gillette
		101.360	Future Little Rawhide Cr. [MFI;SS]
	17	101.770	N. Fork Little Rawhide Cr.
		102.070	Little Powder River Rd.

WY 50			
ML - 300B			
	14	1.330	WY 59 (RM 114.86)
CL 05A		1.533	West Gillette Int. (RM 124.26) [BFX;EB, BFY;WB]
4035		1.683	CL Gillette
		3.040	Lakewood Rd
		3.878	CL Gillette
		4.300	4J Rd
	14	4.325	SCL Gillette
		4.870	Urban Break
	17	5.000	S.B. Road Close Gate R/R
		6.050	SUL Gillette
	7	8.570	Lewis Rd (west)
		12.400	S.B. Road Close Gate R/R
		35.330	Savageton
		35.400	S.B. Road Close Gate R/R
		40.210	Mud Spring Cr. [FKC;SS]
		44.260	S. Branch Four Mile Cr. [FKD;SS]
		52.600	N.B. Road Close Gate R/R
	7	52.665	WY 387 (RM 131.79)

Maint. Section	class	RM	WY 51
			ML - 303B
	14	126.249	WY 59 (RM 113.05)
CL 08Z		126.411	Stonepile Creek [EGL;SS]
4035		126.474	Gurley Av. Viaduct
		127.480	Gillette Port-of-Entry CL 02P
		127.571	I-90; East Gillette Int. (RM 128.09) & US 14/16 (RM 127.57)
		127.676	ECL Gillette
→	14	128.452	Gardner Lake Rd
		●	128.491 UL Gillette
CL 08A	16		
4035		●	129.730 EUL Gillette
	7	131.549	BK= + 0.032 mi.
		131.517	AH Equation
		131.561	Donkey Cr. [LIZ;SS]
		132.160	WYODAK Mine Rd
		132.200	E.B. Road Close Gate R/R
		136.029	BNRR Sep.(Under) WEST WYE [DHD;SS]
		136.169	BNRR Sep.(Under) EAST WYE [DHE;SS]
		136.410	Dry Donkey Cr. [DHF;SS]
		139.919	Unnamed Draw [BGC;SS]
→		140.810	Rozet
		142.287	Donkey Cr. [BGD;SS]
CL 08B		143.600	Donkey Cr. [BGE;SS]
4040		144.363	BNRR Sep. (Under) [LIM;SS]
	7	146.896	Crook Co. Line

			WY 387
			ML - 42B
	6	118.726	Johnson Co. Line
CL 03A		118.871	Dry Fork Powder Rv. [DIT;SS]
2037		131.300	W.B. Road Close Gate swing
→		131.793	WY50 (RM 52.67) Pine Tree Jct. RWIS site {20} District Boundary
CL 03B		137.120	Clark Elen-Turnercrst Rd.
4043		147.900	W.B. Road Close Gate R/R
		149.776	Hay Cr. [DZR;SS]
		150.138	Unnamed Draw [DZS;SS]
		150.630	WCL of Wright
		150.760	Wright Visitor Center
	6	151.259	WY 59 (RM 75.06)

Maint. Section	class	RM	WY 450
			ML - 2300B
	6	45.602	Weston Co. Line
		55.500	E.B. Road Close Gate R/R
CL 07A		55.711	Coal Rd Overpass [DDT;SS]
4043		56.924	BNRR Sep. (Under) [DEX;SS]
		60.573	BNRR Sep. (Under) [DKO;SS]
		66.140	W.B. Road Close Gate R/R
		66.216	WY 59 (RM 72.39)

			I-90 SV. RD.
			ML - 305B
	9	0.000	From Crook County Line (I-90 MP 147.45)
CL 01J		0.760	Gray Rd sep. [BGG;EB][BGH;WB]
4040		1.280	End Sv. Rd. @Farm Unit (I-90 MP 146.18)

			I-90 SV. RD.
			ML - 306B
	9	0.000	Wild Horse CR. Int. (I-90 MP 113.97)
CL 01K		2.130	Jct. Force Rd Int. (I-90 MP 116.24)
4035			

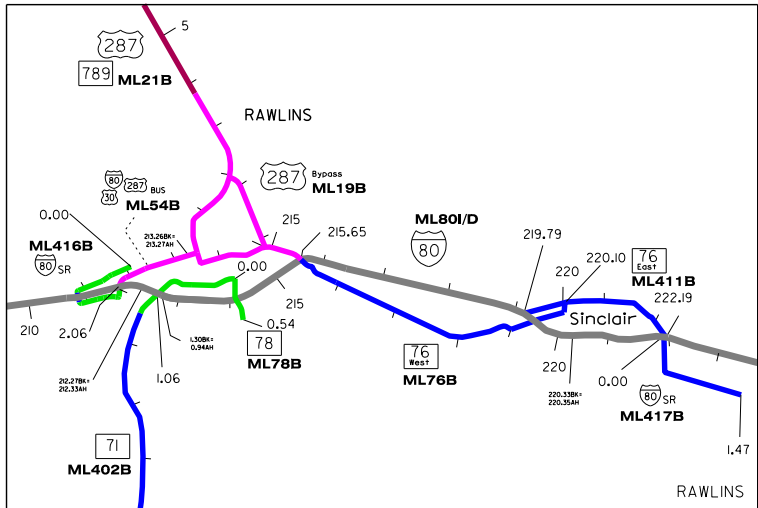
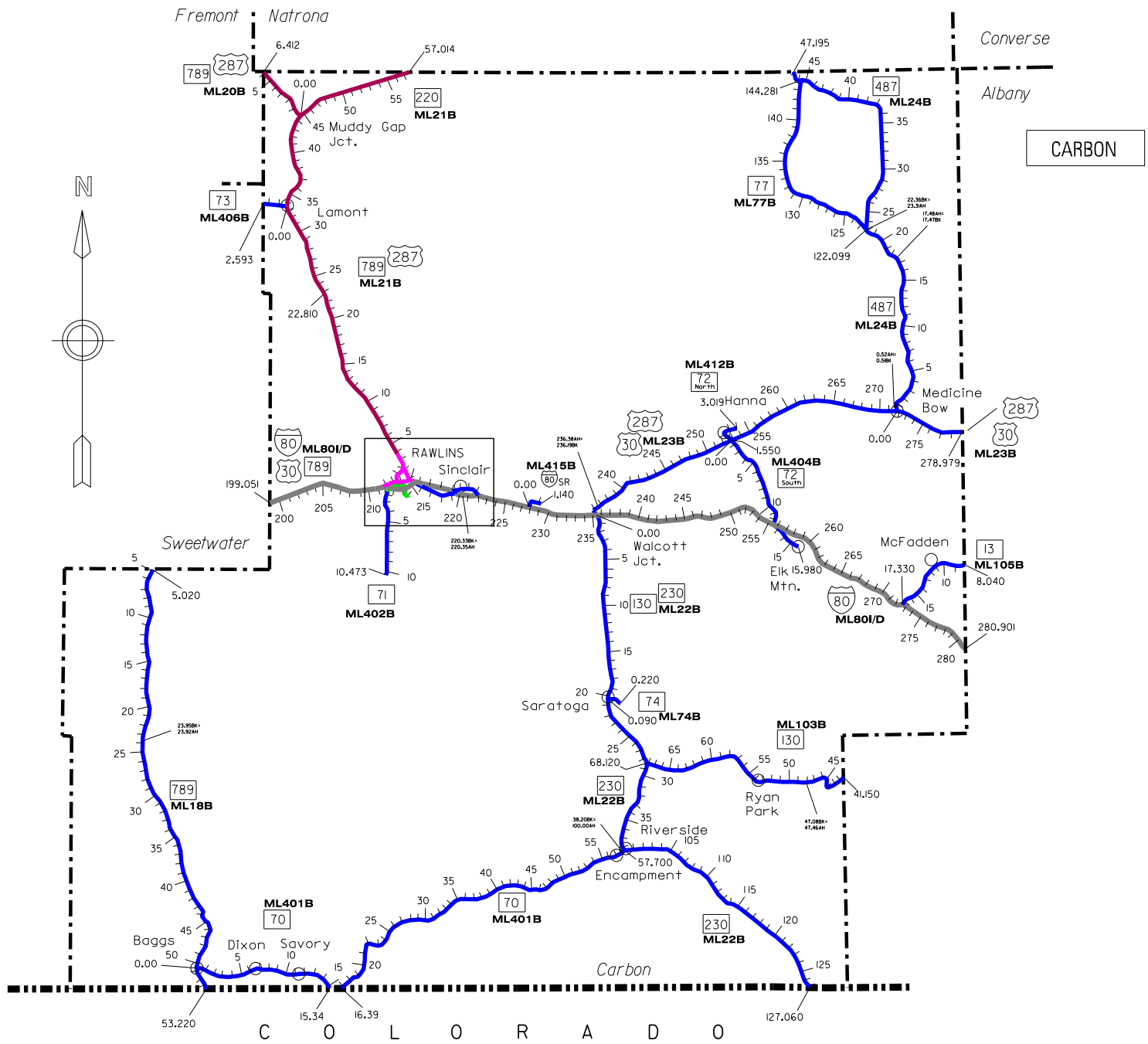

ROAD COLOR TABLE	
	Rural & Urban Interstate #'s "1 & 11"
	Urban Principal Arterial Other & Expressway (NHS) #'s "12 & 14"
	Urban Minor Arterial, Collector & Local (non NHS) #'s "16, 17 & 19"
	Rural Principal Arterial Other (NHS) # "2"
	Rural Minor Arterial, Major & Minor Collectors & Local (non NHS) #'s "6, 7, 8 & 9"

Carbon

County 6

— class "classification break"

+ Indicates Non State System

Maint. Section	class	RM	I-80, US 30/287 & WY 789
CREW		ML - 80	
	1	199.051	Sweetwater Co. Line
		201.164	Daley Int. [ATB;EB, ATC;WB]
		202.144	Separation Cr. [ATD;EB, ATE;WB]
		204.175	Knobs Int. [ATF;EB, ATG;WB]
CB 01A		206.182	Hadsell Int. [ATH;EB, ATI;WB]
1041		206.900	EB C.M.Sign (dynamic) WB C.M.Sign (dynamic)
		208.635	Four Mile Draw [ATJ;EB, ATK;WB]
		209.459	Johnson Rd. Int. [ATL;EB, ATM;WB]
		209.460	W.B. Road Close Gate R/R
	1	210.978	Two Mile Draw Sep. [ATN;EB, ATO;WB]
	—	211.200	WUL Rawlins
	11	211.871	US 30/I-80/287 BUS, WY 789 (RM 211.75); Spruce Street Int. [IYI;SS] End WY 789
		212.270	BK= - 0.061 mi.
		212.331	AH=
		212.407	UPRR Sep. (Under) [ATQ;EB, ATR;WB]
		212.544	WCL Rawlins
		212.738	Sage Cr. Rd Sep. [ATS;EB, ATT;WB]
		214.111	WY 78 (RM 0.152); Thayer Int.[ATU;SS]
		214.630	ECL Rawlins
		215.190	Machinery Pass Sep.[ATV;EB, ATW;WB]
		215.345	UPRR Sep. (Under) [ATX;EB, ATY;WB]
		215.570	US 30/I-80/287 BUS, WY 789/76 (RM 215.65); Cedar Street Int. [MTQ;EB, MFR;WB]
	11		Begin US 287
	—	215.810	EUL Rawlins
	1	217.500	EB C.M.Sign (dynamic) WB C.M.Sign (dynamic)
		218.821	WCL Sinclair
		218.951	Sugar Cr. [KHY;SS]
		219.594	WY 76 (RM 219.79); West Sinclair Int. [KHZ;EB, KJA;WB]
		219.757	UPRR Sep. (Under) [KJB;EB, KJC;WB]
		220.330	BK= - 0.02 mi.
		220.350	AH Equation
		221.006	ECL Sinclair
		221.550	Sinclair RWIS site {33}
CB 01A		221.700	E.B. Road Close Gate R/R
1041		221.926	WY 76 (RM 222.19); E.Sinclair Int.[DAB;SS]
		228.341	Ft. Steele Int. [AUI;EB, AUJ;WB] Ft. Steele Rest Area CB 01R
		229.027	North Platte Rv. [AUK;EB, LCQ;WB]
	1	229.335	Co. Rd Sep. [AUM;EB, AUN;WB]

→ -cont- next column

Maint. Section	class	RM	I-80
CREW		ML - 80	
			(CONTINUED)
	1	234.500	Walcott Jct. RWIS site {34}
CB 01A		234.565	Machinery Pass Sep. [AUO;EB, AUP;WB]
1041		234.600	EB C.M.Sign (dynamic)
		234.660	Walcott Jct RWIS site {34}
		235.230	E.B. Road Close Gate swing
	→	235.228	US 30/287 (RM 235.23); Saratoga Int. [AUQ;EB, AUR;WB] WY 130/230 (RM 0.00)
		236.478	UPRR Sep. (Under) [AUS;EB, AUT;WB]
CB 01B		238.155	Peterson Int. [AUV;EB, AUV;WB]
1040		238.550	EB VSL signs
		243.892	Machinery Pass Sep.[AUW;EB, AUX;WB]
		244.800	Dana Ridge (1) RWIS site {35}
		245.939	Machinery Pass Sep.[AUZ;EB, AUZ;WB]
		246.900	EB & WB VSL signs
		249.100	Elk Mtn (2) RWIS site {36}
		250.000	EB & WB VSL signs
		252.160	Halleck Ridge RWIS site {37}
		252.402	Machinery Pass Sep.[AVA;EB, AVB;WB]
		254.900	WB VSL signs
		255.602	WY 72 (RM 12.29); W. Elk Mountain Int. [CMI;SS]
		256.170	EB VSL signs
			Elk Mtn (3) RWIS site {38}
		258.952	Medicine Bow Rv. [AVC;EB, AVD;WB]
		259.539	E. Fork Medicine Bow Rv. [AVE;EB, AVF;WB]
		259.770	WB VSL signs
		260.232	E. Elk Mountain Int. [AVG;EB, AVH;WB]
		262.000	CR 402 RWIS site {39}
		262.400	EB VSL signs
		263.632	Machinery Pass Sep.[AVI;EB, AVJ;WB]
		266.580	WB VSL signs
			Wagonhound RWIS site {40}
	→	267.186	Wagonhound Int. [AVK;EB, AVL;WB] Wagonhound Rest Area CB 01S
CB 01C		267.710	EB VSL signs
1038		269.500	Foote Cr. RWIS site {41}
		270.446	Co. Rd. Overpass [AVM;EB, AVN;WB]
		271.800	WB VSL signs
			Arlington RWIS site {42}
		272.056	WY 13 (RM 17.33); Arlington Int. [AVO;EB, AVP;WB]
		272.496	Rock Cr. [AVQ;EB, AVR;WB]
		272.757	Machinery Pass Sep.[AVS;EB, AVT;WB]
		273.403	Canon Ditch [AVU;EB, AVV;WB]
		273.850	EB VSL signs
	1		Arlington RWIS site {43}

- -cont- next page

Maint. Section	class	RM	I-80
CREW			ML - 80
-cont-			(CONTINUED)
CB 01C	1	275.370	Machinery Pass Sep.[AVW;EB, AVX;WB]
		278.116	Machinery Pass Sep.[AVY;EB, AVZ;WB]
1038		279.359	WB VSL signs
			Cooper Cove RWIS site {44}
		279.859	Cooper Cove Int. [AWA;EB, AWB;WB]
		280.360	EB VSL signs
		280.901	Albany Co. Line

US 30/I-80/287 BUS & WY 789			
Maint. Section	class	RM	
			ML - 54B
CB 02A	14	211.750	I-80 (RM 211.78); Spruce Street Int. [IYI;SS] and County Rd
1041		212.020	WCL Rawlins
		213.257	BK= -0.013 mi.
		213.270	AH Equation
CB 02Z		213.400	US 287 (RM 0.20)
1041			End WYO 789 Bus./Begin US 287 Bus.
		213.604	3rd & Cedar street
		214.883	US 287 Bypass (RM 0.77)
			Begin NHS
		215.149	Airport Rd
		215.200	EB C.M.Sign (dynamic)
		215.350	Dept. Shop Rawlins RW 01A
		215.423	ECL Rawlins
	14	215.651	I-80 (RM 215.57); Cedar Street Int. & WY 76 (RM 215.65)
			End NHS

US 30 /287			
Maint. Section	class	RM	
			ML - 23B
CB 19A	6	235.230	I-80 (RM 235.28); Saratoga Int. [AUQ;EB, AUR;WB] & WY 130/230 (RM 0.00)
1036		235.460	EB C.M.Sign (dynamic)
		235.500	E.B. Road Close Gate R/R
		236.191	BK= - 0.186 mi.
		236.377	AH Equation
		246.697	St. Mary's Cr. [CIP;SS]
		252.714	WY 72 (RM 1.55 south) & (0.00 north); Hanna Jct.
CB 19B		260.315	UPRR Sep. [CTV;SS]
1036		260.387	Unnamed Draw [MKT;SS]
		268.744	First Sand Cr. [BKQ;SS]
		270.290	Dept. Shop - Medicine Bow MB 01A
		271.144	WCL Medicine Bow
		271.440	W.B. Road Close Gate swing
		271.640	WY 487 (RM 0.00)
		272.320	E.B. Road Close Gate R/R
		272.653	ECL Medicine Bow
		274.599	Medicine Bow Rv. [BKE;SS]
	6	278.979	Albany County Line

Maint. Section	class	RM	US 287 & WY 789
CREW			ML - 20B
	2	0.000	WY 220 (RM 44.31)
CB 03A			Begin NHS
2036		0.020	W.B. Road Close Gate R/R
		0.162	Muddy Cr. [BSP;SS]
		2.030	WB C.M.Sign (dynamic)
		6.412	Fremont Co. Line
			Cont. NHS

US 287 Bypass			
Maint. Section	class	RM	
			ML - 19B
	14	0.768	US 30/287, I-80 BUS (RM 214.88)
		1.027	E. Daley St.
CB 23A		1.217	NCL Rawlins
1041		1.301	E. Murray Street
		2.002	Aberdeen blvd.
		2.286	US 287 Mainline (RM 1.92)

US 287 & WY 789/220			
Maint. Section	class	RM	
			ML - 21B
	14	0.197	US 30,I-80 BUS. (RM 213.40)
CB 04Z		0.450	City Shop
1041		0.750	End Divided Section
		1.187	NCL Rawlins
CB 04A		1.919	US 287 Bypass (RM 2.29)
1041	14	2.030	NB C.M.Sign (dynamic)
		2.080	N.B. Road Close Gate R/R
		3.090	NUL Rawlins
	2		Begin NHS
		13.792	Bell Springs Draw [BTW;SS]
		15.250	Union 76 Rd
		22.810	District Boundary
		30.837	Antelope Pass Sep. [BTX;SS]
CB 04B		32.580	S.B. Road Close Gate R/R
2036		33.264	WY 73 (RM 0.00)
		33.300	N.B. Road Close Gate R/R
		37.380	Unnamed Draw [LGK;SS]
		42.290	Unnamed Draw [GUL;SS]
		42.745	Muddy Cr. [BTY;SS]
		43.080	W.B. Road Close Gate swing
		43.260	Dept. Shop - Muddy Gap MG 02A
		44.311	WY 220 (RM 0.00)
			End US 287 & WY 789/Begin WY 220
		44.350	E.B. Road Close Gate R/R
		53.298	Unnamed Draw
		55.764	Pete Cr. [BUB;SS]
	2	57.014	Natrona Co. Line

Maint. Section	class	RM	WY 13
			ML - 105B
	7	8.035	Albany Co. Line
CB 07A		9.468	Three Mile Cr. [CIW;SS]
1038		10.670	Big Harrison Ditch [DJT;SS]
		11.240	McFadden
		14.051	Rock Cr. [DJS;SS]
		16.890	Dept. Shop - Arlington AR 01A
		17.325	I-80 (RM 272.06); Arlington Int. [AVO;EB, AVP;WB]

Maint. Section	class	RM	WY 70
			ML - 401B
	7	0.000	WY 789 (RM 50.70)
CB 09A		0.320	ECL Baggs
1037		0.998	Ledford Slough [FSD;SS]
		2.352	Irrigation Canal
		5.840	Irrigation Canal [JDI;SS]
		6.062	Little Snake Rv. [BLY;SS]
		6.588	WCL Dixon
		7.094	ECL Dixon
		7.352	Cottonwood Cr. [CLT;SS]
		11.381	Savery
		11.667	Savery Cr. [JCP;SS]
		15.344	Colorado St. Line West
			1.06 mi. in Colorado
		16.390	Colorado St. Line East
		21.245	West Medicine Bow Nat'l. Forest Boundary
		26.900	E.B. Road Close Gate swing <i>Seasonal Closure</i>
		30.682	BK= - 0.251 mi.
		30.933	AH Equation
		32.900	E.B. Road Close Gate swing <i>1st Seasonal Closure</i>
		41.030	Maint. Break
		50.000	W.B. Road Close Gate swing <i>Seasonal Closure</i>
CB 09B		50.630	East Medicine Bow Nat'l Forest Boundry
1042		50.680	Hog Park Rd
		55.790	WCL Encampment
		57.460	CL Encampment & Riverside
	7	57.701	WY 230 (RM 38.20)

Maint. Section	class	RM	WY 71
			ML - 402B
	16	0.000	WY 78 (RM 0.00)
CB 10Z		0.760	Urban Break
1041	17	1.300	BK= + 0.36 mi.
		0.940	AH Equation
		1.060	Sage Cr. Rd Sep. [ATS;EB, ATT;WB]
			I-80 (RM 212.74)
	17	1.249	SCL Rawlins
CB 10A		2.270	SUL Rawlins
1041	7	10.474	End SHS

Maint. Section	class	RM	WY 72 (north)
			ML - 412B
	7	0.000	US 30/287 (RM 252.71); Hanna Jct. WY 72 (MP 1.55) south
CB 21A		0.714	SCL Hanna
1040		1.321	UPRR Sep. (Under) [CMF;SS]
		2.739	CL Hanna
		2.980	CL Hanna
		3.020	End SHS

Maint. Section	class	RM	WY 72 (south)
			ML - 404B
	7	1.550	US 30/287 (RM 252.71); Hanna Jct. WY 72 (RM 0.00) north
CB 12A		1.590	S.B. Road Close Gate R/R
1040		6.340	Unnamed Draw [MDK;SS]
		12.030	N.B. Road Close Gate R/R
		12.294	I-80 (RM 255.60)
			W. Elk Mountain Int. [CMI;SS]
		15.200	Dept. Shop - Elk Mountain EM 01A
		15.684	WCL Elk Mountain
		15.772	Hedsell Slough Cr. [DDI;SS]
	7	15.976	End SHS

Maint. Section	class	RM	WY 73
			ML - 406B
CB 14A	7	0.000	US 287 (RM 33.26) @LAMONT
2036		2.587	Sweetwater Co. Line

→ -cont- in Sweetwater county

Maint.
Section

CREW	class	RM	WY 74
			ML - 74B
	+	0.000	WY 130 (RM 20.28) <i>0.09 mi. not on SHS</i>
		0.090	Begin State
CB 15A	8	0.151	North Platte Rv. [CMW;SS]
1042		0.218	End SHS

WY 76 (east)

CREW	class	RM	WY 76 (east)
			ML - 411B
	7	219.794	I-80 (RM 219.59); W. Sinclair Int. [KHZ;EB, KJA;WB]
CB 22Z		220.006	WY 76 (RM 220.01)
1041		220.910	RR at Grade Crossing (Spur)#81092K
		220.920	RR at Grade Crossing (Spur)#81092K
		221.042	ECL Sinclair
		221.678	UPRR Sep. (Under) [CID;SS]
		222.186	I-80 (RM 221.926); E. Sinclair Int. [DAB;SS]

WY 76 (west)

CREW	class	RM	WY 76 (west)
			ML - 76B
	8	215.650	I-80 (RM 215.57); Cedar Street Int. [MFQ;EB, MFR;WB]
CB 17A			US 30, I-80 BUS. (RM 215.65)
1041		219.029	WCL Sinclair
		219.824	UPRR Sep. [?] REMOVE??
		220.010	Lincoln Avenue

WY 77

CREW	class	RM	WY 77
			ML - 77B
	8	122.099	WY 487 (RM 22.162) N.B. Road Close Gate swing
CB 24A		128.932	Muddy Cr. [BLZ;SS]
2041	8	131.124	Class. Break
	9	132.550	N.B. Road Close Gate swing <i>Seasonal Closure</i>
		138.609	Shirley Basin Road
		142.300	S.B. Road Close Gate swing <i>Seasonal Closure</i>
	9	144.281	WY 487 (RM 46.03)

WY 78

CREW	class	RM	WY 78
			ML - 78B
CB 20A	16	0.000	WY 71 (RM 0.00)
1041		0.152	I-80 (RM 214.11); Thayer Int. [ATU;SS]
		0.540	End SHS

Maint.
Section

CREW	class	RM	WY 130
			ML - 103B
	7	41.150	Albany Co. Line
		47.082	BK= - 0.376 mi.
		47.458	AH Equation
CB 06A		47.900	E.B. Road Close Gate swing <i>Seasonal Closure</i>
1042		53.670	Ryan Park
		55.542	South Brush Creek [MNJ;SS]
		56.300	Medicine Bow Nat'l. Forest Boundary
		57.050	North Brush Cr. [CIO;SS]
		57.785	Unnamed Draw [BLI;SS]
		65.917	Elk Hollow [KMA;SS]
		67.152	North Platte Rv. [KMB;SS]
	7	68.020	WY 230 (MP 28.09)

WY 130/230

CREW	class	RM	WY 130/230
			ML - 22B
	6	0.000	I-80 (RM 235.28); Saratoga Int. [AUQ;EB, AUR;WB]
CB 05A			& US 30/287 (RM 235.23)
1042		0.350	S.B. Road Close Gate swing
		2.111	Pass Cr. [DIX;SS]
		4.540	Rattlesnake Rd
		8.660	Pass Creek Rd
		17.040	Lake Cr. [GVF;SS]
		17.660	Fish Hatchery Rd
		18.710	N.B. Road Close Gate swing
		19.653	NCL Saratoga
		19.999	North Platte Rv. [BUR;SS]
		20.280	WY 74 (RM 0.00)
		20.700	Old Dept Site
		21.428	SCL Saratoga
		22.286	Spring Cr. [BUS;SS]
		23.200	Dept. Shop - Saratoga SG 01A
		28.090	WY 130 (RM 68.119) End WY 130 / Begin WY 230
		30.113	Cow Cr. [BUT;SS]
		38.148	NCL Riverside
	6	38.200	BK= - 61.80 mi.
			Maint. Brk. @ Equation
	6	100.000	AH Equation WY 70 (RM 57.701)
CB 11A		100.346	Encampment Rv. [DJK;SS]
1042		100.424	ECL Riverside
		100.540	Finch Rd (north)
		101.200	E.B. Road Close Gate swing
		104.170	Indian Creek Rd (north)
		109.538	Beaver Cr. [DHG;SS]
		109.950	Beaver Creek Rd (west)
		113.200	Skyline RWIS site {7}
		118.401	Big Cr. [FHF;SS]
		119.240	Big Creek Rd (west)
	6	127.060	Colorado State Line

Maint. Section	class	RM	WY 487
			ML - 24B
CB 13A	6	0.000	US 30/287 (RM 271.64)
1036		0.600	NB C.M.Sign (dynamic)
		0.740	N.B. Road Close Gate swing
		0.812	Medicine Bow Rv. [CML;SS]
		1.170	NCL Medicine Bow
		4.013	Little Medicine Bow Rv. [CMM;SS]
		13.104	T.B. Cr.
		17.563	Marshall Rd
		22.162	WY 77 (RM 122.099)/ Dist. Boundary
		22.355	BK= - 0.959 mi.
CB 13B		23.314	AH Equation
2041		33.640	Sand Creek [FFE;SS]
		37.000	RWIS {77}
		37.500	Shirley Basin Rd
		45.100	Shirley Basin Rest Area CB 13R
			Dept. Shop - Shirley Rim SR 02A
		45.130	S.B. Road Close Gate R/R
		46.025	WY 77 (RM 144.281)
	6	47.200	Natrona Co. Line

			WY 789
			ML - 18B
CB 08A	6	5.018	Sweetwater Co. Line
1037		20.560	Muddy Cr. [CLM;SS]
		23.948	BK= + 0.026 mi.
		23.922	AH Equation
		28.890	Mexican Flats Rd
		30.366	Muddy Cr. [CLO;SS]
		36.710	Robber's Gulch [GR;SS]
		37.930	Little Robber's Gulch [GRK;SS]
		43.380	Cottonwood Creek [GRM;SS]
		45.000	Deer Underpass [MGJ;SS]
		47.620	N.B. Road Close location R/R Gate
		49.520	Poison Butte & Gov. Rd (west)
		50.310	Little Snake Rv. [DJF;SS]
		50.337	NCL Baggs
		50.698	WY 70 (RM 0.00)
		50.843	SCL Baggs
		51.900	Dept. Shop - Baggs BG 01A
		52.070	Baggs Port-of-Entry CB 08P
	6	53.223	Colorado State Line

Maint. Section	class	RM	I-80 SV. RD.
			ML - 415B
CB 01K	9	0.000	I-80 (RM 228.34); Ft. Steele Int.
1041			[AUI;EB, AUJ;WB] (northside)
		0.500	Ft. Steele Rest Area
		0.740	North Platte Rv. [DLT;NSR]
		1.140	End Sv. Rd. @Co. Rd. Sep.
			[AUM;EB, AUN;WB] (RM 229.34)

			I-80 SV. RD.
			ML - 416B
CB 01J	17	0.000	From 23rd Street West
1041		1.130	WUL Rawlins
	9	1.150	I-80 (RM 210.98) 2 Mile Draw Sep.
	9		[ATN;EB, ATO;WB]
		1.310	WUL Rawlins
	19	2.060	End Sv. Rd. @Jct. I-80 (RM 211.78)

			I-80 SV. RD.
			ML - 417B
CB 01M	9	0.000	I-80 (RM 221.93); East Sinclair Int.
1041			[DAB;SS]
		1.470	End Sv. Rd. @Cattle Guard

CONVERSE

Johnson

Campbell

Weston
Niobrara

Natrona

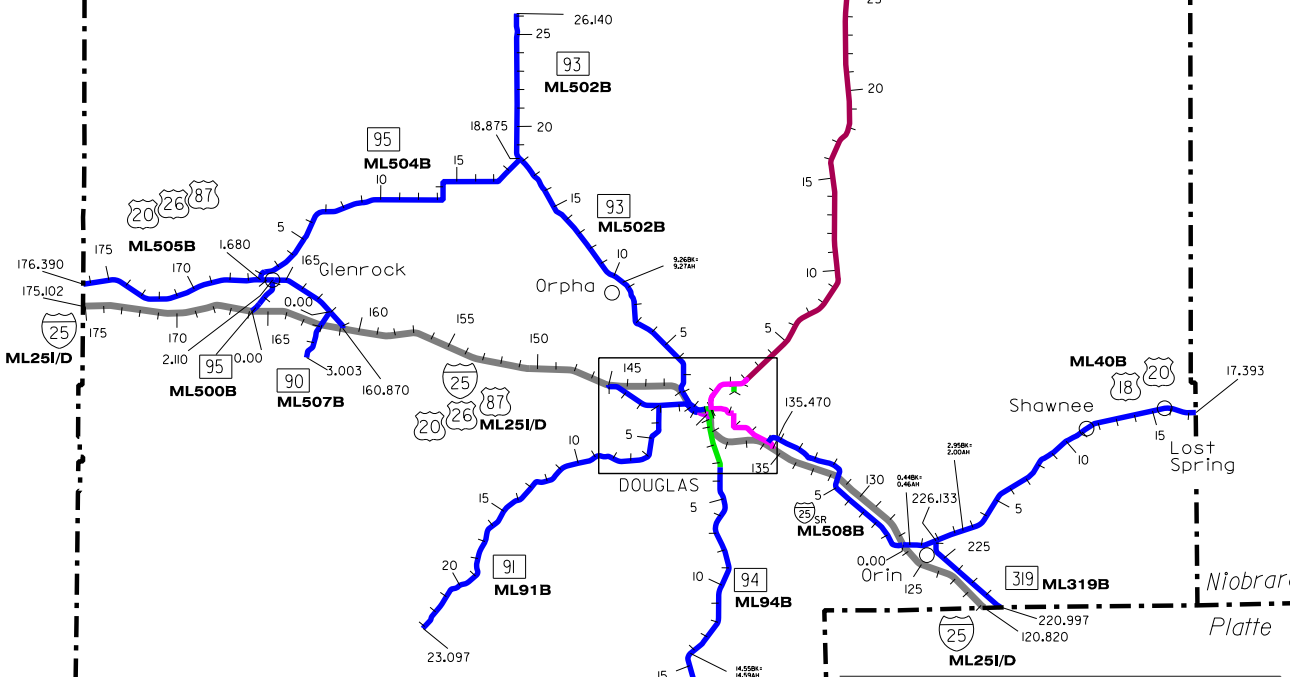
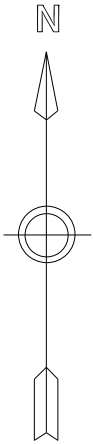
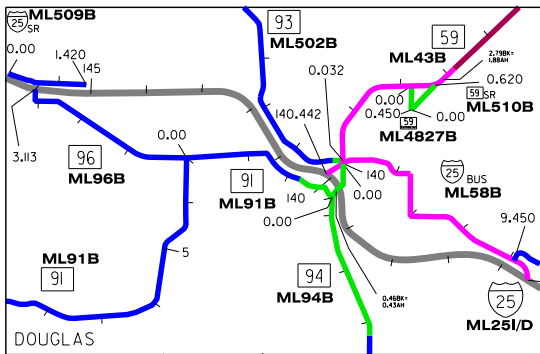

ROAD COLOR TABLE	
	Rural & Urban Interstate #'s "1 & 11"
	Urban Principal Arterial Other & Expressway (NHS) #'s "12 & 14"
	Urban Minor Arterial, Collector & Local (non NHS) #'s "16, 17 & 19"
	Rural Principal Arterial Other (NHS) # "2"
	Rural Minor Arterial, Major & Minor Collectors & Local (non NHS) #'s "6, 7, 8 & 9"

Natrona

Converse

Carbon

Albany

Converse

class "classification break"

County 13

Maint. Section	class	RM	I-25, US 20/26/87	Maint. Section	class	RM	I-25
			ML - 25				ML - 25
	1	120.817	Platte Co. Line				<i>(CONTINUED)</i>
CO 01A		123.524	Indian Cr. [CZO;NB, CZP;SB]	CO 01A	1	164.572	Machinery Pass Sep.[AHD;NB, AHE;SB]
		124.024	Machinery Pass Sep.[CZQ;NB, CZR;SB]		2034	164.851	Deer Cr. [AHF;NB, AHG;SB]
		125.519	North Platte Rv. [CZS;NB, CZT;SB]			165.909	WY 95 (RM 0.00); Deer Cr. Int.
		126.059	BNRR Sep. (Under) [CZU;NB, CZV;SB]		1		[AHH;NB, AHI;SB]
		126.131	C&NW RR Sep.(Under)[CZW;NB, CZX;SB]	CO 01B		170.679	Dwyer Rd Sep. [AHJ;NB, AHK;SB]
		126.430	Sand Creek [LHT;SS]		2031	172.122	Machinery Pass Sep. [AHL;NB, AHM;SB]
		126.467	US 18/20 (RM 0.00); Orin Jct. Int. [CZC;SS] Begin US 26			174.660	Co. Rd Sep. [AHN;SS]
			Orin Jct. Rest Area CO 01R			175.102	Natrona Co. Line
			126.720 S. B. Road Close Gate R/R				US 18/20
			127.060 SB C.M.Sign (dynamic)				ML - 40B
			131.590 Co. Rd Sep. [AFO;NB, AFP;SB]		2	0.000	I-25 (RM 126.47);Orin Jct. Int. [CZC;SS]
			133.730 NB & SB C.M.Sign (dynamic)			0.437	BK= - 0.018 mi.
		1	134.900 S.B. Road Close Gate R/R		CO 03A	0.455	AH Equation
			135.440 EUL Douglas			0.962	C&NW RR Sep. (Under) [DBE;SS]
	11	135.472 US 20/26/87 & I-25 BUS. (RM 135.48); E. Douglas Int. [AFQ;NB, AFR;SB]			1.620	BNRR Sep. (Over) [MCP;SS]	
		137.408 Golf Course Rd Sep. [AFT;NB, AFU;SB]			1.836	WY 319 (RM 226.133)	
		137.558 BNRR Sep. (Under) [AFV;NB, AFW;SB]				E.B. Road Close Gate swing	
		137.601 Irvine Co. Rd. [AFX;NB, AFY;SB]			2.885	Shawnee Cr. [DBF;SS]	
		138.654 North Platte Rv. [AFZ;NB, AGA;SB]			2.945	BK= + 0.942 mi.	
		139.750 ECL Douglas			2.003	AH Equation	
		139.760 Esterbrook Rd Sep. [AGB;NB, AGC;SB]			7.302	Fero Draw [CEV;SS]	
		139.970 N.B. Road Close Gate R/R			8.174	Unnamed Draw [CEW;SS]	
	11	140.028 WCL Douglas			11.275	Shawnee	
		140.101 US 20/26/87 & I-25 BUS. (RM 140.44); W. Douglas Int. [BLM;SS]			13.730	Watkins Draw [CEX;SS]	
	1	141.569 Six Mile Cr. [AGD;SS]			15.594	WCL Lost Springs	
		141.710 SB C.M.Sign (dynamic)			15.734	ECL Lost Springs	
		141.720 NB C.M.Sign (dynamic)			15.900	Lost Cr. [CEY;SS]	
		143.316 Five Mile Cr. [AGF;NB, AGG;SB]			17.390	Niobrara Co. Line / Cont. NHS	
		146.003 WY 96 (RM 3.11); LaPrele Int. [AGH;NB, AGI;SB]				US 20/26/87 BUS. & I-25 BUS.	
		147.457 LaPrele Cr. [AGJ;NB, AGK;SB];				ML - 58B	
		149.780 Alkali Cr. [AGL;SS]			14	135.476 I-25 (RM 135.47); E. Douglas Int. [AFQ;NB, AFR;SB]	
		150.442 Inez Int. [AGM;NB, AGN;SB]		CO 02Z		135.570 SB C.M.Sign (dynamic)	
		151.166 Natural Bridge Int. [AGO;SB, AGP;NB]			2034	135.834 End Divided Section	
		154.244 Barber Int. [FXN;MSS]			135.928	ECL Douglas	
		155.383 Little Boxelder Cr. [AGR;NB, AGS;SB]			137.800	Dept. Shop - Douglas DG 02A	
		155.867 Boxelder Cr. [AGT;NB, AGU;SB]			138.020	4th & Richards streets	
		156.178 Bixby Int.[AGV;NB,AGW;SB]			138.755	Begin 4 Lane	
		160.871 US 20/26/87 (RM 160.87);E. Glenrock Int. [AGX;NB, AGY;SB], End US 20/26/87			139.460	North Platte Rv. [MAC;SS]	
		162.038 Boxelder Rd Sep. [AGZ;NB, AHA;SB]			138.936	End 4 Lane	
		163.950 Morman Canyon Rd Sep. [AHB;NB, AHC;SB]				RR at Grade Crossing #089293E	
	1	164.250 Deer Creek RWIS site {15}			139.458	North Platte Rv. [CNN;SS]	
					140.075	WY 59 & WY 94 (RM's 0.00)	
						WCL Douglas	
					14	140.442 I-25 (RM 140.10); West Douglas Int. [BLM;SS]	

-cont- next column

Maint. Section	class	RM	US 20/26/87
			ML - 505B
CO 10A	7	160.870	I-25 (RM 160.87); East Glenrock Int.
		161.120	N.B. Road Close Gate R/R
			S.B. Road Close Gate R/R
2034		162.054	WY 90 (RM 0.00)
		162.868	Middle Fork Dry Cr. [CWO;SS]
CO 10Z		163.627	ECL Glenrock
		165.440	Deer Cr. [CNW;SS]
2034		165.538	Begin Divided Section
CO 10Y		165.701	WY 95 (RM 2.13)
2031			Crew Break
		166.030	End Divided Section
		166.220	WCL Glenrock
CO 10B			WY 95 (RM 1.68)
2031		171.510	Cole Creek Rd
		172.430	Big Wash Cr.
		175.370	Big Muddy Cr. [JDR;SS]
	7	176.390	Natrona Co. Line.

WY 59			
ML - 43B			
	14	0.000	US 20/26/87 bus. (RM 140.08)
CO 04Z		0.065	WY 93 (RM 0.03)
2034		0.140	Riverbend Drive
		0.220	N.B. Road Close Gate swing
		0.380	SCL Douglas
		0.663	NCL Douglas
CO 04A		0.706	North Platte Rv. [FDB;SS]
2034		1.156	BNRR Sep. [FDC;SS]
		1.950	S.B. Road Close Gate swing
		2.200	WY 59 Conn. (RM 0.00)
			4th Street
		2.600	Jct. Sv. Rd. ML 510 (RM 0.62)
		2.789	BK= + 0.912 mi.
	14	1.877	AH Equation
		3.100	NUL Douglas
	2	3.190	NB C.M.Sign (dynamic)
		3.620	N.B. Road Close Gate R/R
		6.254	Antelope Cr. [CFS;SS]
		10.700	Walker Rd (east)
		17.608	BNRR Sep. (Over) [DIA]
		21.992	Lightning Cr. [DIS;SS]
		26.543	Box Cr. [DJC;SS]
		28.460	Mikes Draw [HUQ;SS]
		32.800	Unnamed Draw [HUT;SS]
		36.220	County Rd (east)
		40.419	BNRR Sep. (Under) [DIP;SS]
		42.776	S. Fork Cheyenne Rv. [JJW;SS]
		43.100	Cheyenne River Rest Area CO 04R
		43.660	Dilts Hollow [HUW;SS]
		54.076	Antelope Cr. [JFB;SS]
	2	56.507	Campbell Co. Line / District Boundary

Maint. Section	class	RM	WY 59 Connector
			ML - 4827B
CO 24A	16	0.000	WY 59 Mainline (RM 2.20)
2034		0.450	Jct. 4th St. End SHS
			WY 90
			ML - 507B
CO 05A	8	0.000	US 20/26/87 (RM 162.05)
2034		0.855	Boxelder Rd Sep. [AGZ;NB, AHA;SB]
		3.003	End SHS
			WY 91
			ML - 91B
CO 06Z	17	0.000	WY 94 (RM 0.505)
2034		0.039	SCL Douglas
		0.224	WCL Douglas
		0.780	WUL Douglas
CO 06A	8	1.882	Six Mile Cr.
2034		2.988	WY 96 (RM 0.00)
	8	23.097	End SHS

WY 93			
ML - 502B			
	17	0.032	WY 59 (RM 0.065)
CO 07A	17	0.060	CL Douglas
2034		0.270	WUL Douglas, End U-0502
	7	1.706	Six Mile Cr. [CMZ;SS]
		3.150	Five Mile Cr.
		8.627	North Platte Rv. [FMA;SS]
		8.695	RR at Grade Crossing #089301U
		8.870	Orpha
		9.259	BK= - 0.014 mi.
		9.273	AH Equation
		18.212	WY 95 (RM 18.876)
	7	26.140	End SHS

Maint. Section	class	RM	WY 94
ML - 94B			
CREW			
	16	0.000	US 20/26/87 bus. (RM 140.08)
CO 08Z		0.460	BK= + 0.031 mi.
2034		0.429	AH Equation
			Esterbrook Rd Sep. [AGB;NB, AGC;SB]
			SCL Douglas
	16	0.505	WY 91 (RM 0.00)
		3.290	SUL Douglas
CO 08A	8	3.860	County Rd (west)
2034		4.062	Bed Tick Cr. [CNC;SS]
		5.206	Esmay Draw [CND;SS]
		7.510	Warm Springs
		8.619	Wagonhound Cr. [CNE;SS]
		14.550	BK= - 0.042 mi.
		14.592	AH Equation
		14.902	West Fork LaBonte Cr. [CNF;SS]
	8	16.614	End SHS

Maint. Section	class	RM	WY 319
ML - 319B			
CREW			
	8	220.997	Platte Co. Line
		221.915	Valley Ditch [FEH;SS]
CO 12A		224.500	Indian Cr. [CZA;SS]
2034		225.309	North Platte Rv. [CZB;SS]
		226.110	S.B. Road Close Gate swing
		226.133	US 18/20 (RM 1.84)

WY 95			
ML - 500B			
	7	0.000	I-25 (RM 165.909); Deer Cr. Int.
CO 13A			[AHH;NB, AHI;SB]
2034		1.384	SCL Glenrock
		2.129	US 20/26/87 (RM 165.70)

I-25 SV. RD. E. Yellowstone Hwy/Orin Way			
ML - 508B			
	9	0.000	Begin @ I-25; Orin Jct. Int. (RM 126.47)
CO 01K		2.910	Schneider Draw
2034		5.130	I-25 Sep. (RM 131.59)
			[AFO;NB, AFP;SB]
		8.951	NEW_Dept. Shop - Douglas DG 02A
		9.450	End Sv. Rd. @US 20/26/87 bus. (RM 135.47)

WY 95			
ML - 504B			
CO 09Z	7	1.680	US 20/26/87 (RM 166.22)
2034		1.870	CL Glenrock
		2.110	NCL Glenrock
		2.700	North Platte Rv. [JDN;SS]
		2.820	River Approach
		2.830	North Platte Rv. [JDO;SS]
CO 09B		3.060	BNRR Sep. [JDP;SS]
2034		6.667	Railroad Sep. [DDE;SS]
		7.378	Sand Cr. [DDD;SS]
		15.230	LeuenbergerLane (south)
	7	18.876	WY 93 (RM 18.21)

I-25 SV. RD.			
ML - 509B			
	9	0.000	Begin at Dead End
CO 01L			0.43 Mi. NW of LaPrele Int.
2034		0.430	I-25 (LaPrele Int.)
		1.420	End at Dead End
			0.99 Mi. SE of LaPrele Int.

WY 96			
ML - 96B			
CO 11A	8	0.000	WY 91 (RM 2.99)
2034		3.113	I-25 (RM 146.00); LaPrele Int.
			[AGH;NB, AGI;SB]

WY 59 SV. RD.			
ML - 510B			
	19	0.000	Begin at NCL of Douglas
CO 04K			Old WYO 59 (4th St. Rd.)
2034		0.620	End Sv. Rd. at WY 59 (RM 2.60)

WY 95 SV. RD. 6th Street			
ML - 19628B			
CO 09K	8	100.251	W. Platte St.
2034		100.400	End SHS @WY 95 (RM 2.37).
			Glenrock

M O N T A N A

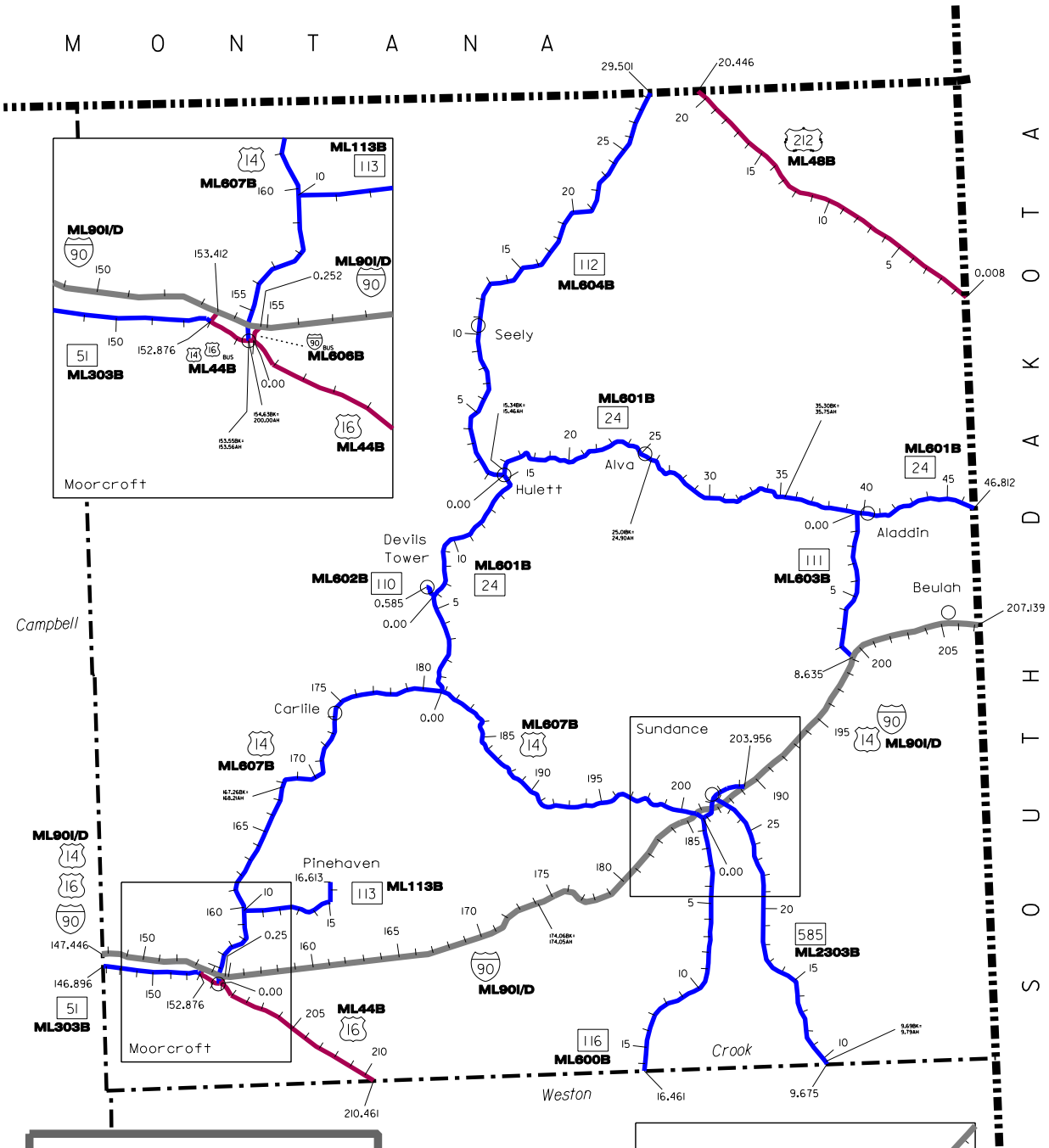
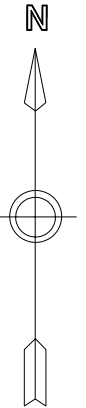

ROAD COLOR TABLE	
	Rural & Urban Interstate #'s "1 & 11"
	Urban Principal Arterial Other & Expressway (NHS) #'s "12 & 14"
	Urban Minor Arterial, Collector & Local (non NHS) #'s "16, 17 & 19"
	Rural Principal Arterial Other (NHS) # "2"
	Rural Minor Arterial, Major & Minor Collectors & Local (non NHS) #'s "6, 7, 8 & 9"

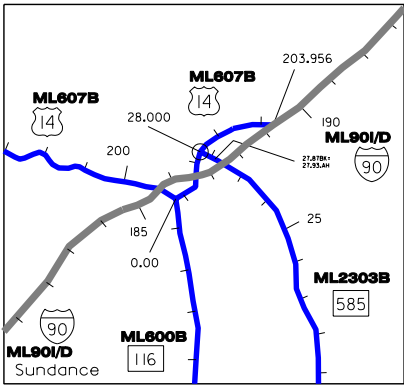

Crook

class "classification break"

County 18

Maint. Section	class	RM	I-90 & US 14/16
CREW		ML - 90	
	1	147.450	Campbell Co. Line
		147.590	Well Cr. [BGI;EB, BGJ;WB]
CR 01A		148.760	Machinery Pass Sep. [BGL;EB, BGM;WB]
4040		152.020	"D" Rd Overpass [BGN;EB, BGO;WB]
		152.260	Donkey Cr. [BGP;EB, BGQ;WB]
		152.920	Bell Fourche Rv. [BGS;EB, BGT;WB]
		153.412	I-90 BUS.(RM 153.41);W. Moorcroft Int. [BGV;EB, BGW;WB] , End US 14 & 16
			Dept. Shop Moorcroft MC 04A
			Moorcroft Rest Area CR 01R
		153.735	WCL Moorcroft
		153.900	W.B. Road Close Gate R/R
		154.343	US 14 Highway Sep. [BGX;EB, BGY;WB]
		154.686	I-90 BUS.(RM 0.25); E. Moorcroft Int. [BGZ;EB, BHA;WB] Spur
		154.769	ECL Moorcroft
			E.B. Road Close Gate R/R
		155.064	Co. Rd Sep. [BHB;EB, BHC;WB]
		155.992	Co. Rd Sep. [BHD;EB, BHE;WB]
		157.621	Co. Rd Sep. [BHF;EB, BHG;WB]
		160.658	Wind Cr. Int. [BHH;EB, BHI;WB]
		161.465	Wind Cr. [BHJ;EB, BHK;WB]
		161.940	Machinery Pass Sep. [BHL;EB, BHM;WB]
		164.595	Mule Cr. [BHN;SS]
		165.677	Pine Ridge Int. [BHO;SS]
		166.909	Co. Rd Sep. [BHP;EB, BHQ;WB]
		167.417	Tom Cat Cr. [BHR;EB, BHS;WB]
		168.112	Co. Rd Sep. [BHT;EB, BHU;WB]
		169.426	Arch Cr. [BHV;EB, BHW;WB]
		169.561	Co. Rd Sep. [BHX;EB, BHY;WB]
		170.510	Inya Kara RWIS site {57}
		170.649	Co. Rd Sep. [BHZ;EB, BIA;WB]
		171.264	Co. Rd Sep. [BIB;SS]
		171.860	Inyan Kara Cr. [BIC;EB, BID;WB]
		172.092	Inyan Kara Int. [BIE;EB, BIF;WB]
		173.006	Houston Cr. [BIG;EB, BIH;WB]
		173.158	Co. Rd Sep. [BII;EB, BIJ;WB]
		173.951	Co. Rd Sep. [BIK;EB, BIL;WB]
		174.058	BK= + 0.011 mi.
		174.047	AH Equation
		174.475	Co. Rd Sep. [BIM;EB, BIN;WB]
		175.375	Co. Rd Sep. [BIO;EB, BIP;WB]
		177.784	Co. Rd Sep. [BIQ;EB, BIR;WB]
		178.190	Co. Rd Sep. [BIS;EB, BIT;WB]
		178.916	Beaver Creek Rd Int. [BIU;EB, BIV;WB]
		179.439	Beaver Cr. [BIW;EB, BIX;WB]
		181.823	Machinery Pass Sep. [BIY;EB, BIZ;WB]
	1	182.695	Co. Rd Sep. [BJA;EB, BJB;WB]

-cont- next column

Maint. Section	class	RM	I-90 & US 14
CREW		ML - 90	
			<i>(CONTINUED)</i>
	1	183.240	EB C.M.Sign (dynamic)
			WB C.M.Sign (dynamic)
		184.350	Cundy Creek [GDM;SS]
		185.540	Unnamed Draw [BJC;SS]
CR 01B		185.700	W.B. Road Close Gate R/R
4042		185.730	US 14 (RM 200.54); West Sundance Int. [BJD;EB, BJE;WB]
		186.437	WCL Sundance
		186.598	CL Sundance
		186.610	US 14 Overpass [BJF;EB, BJG;WB]
		186.690	CL Sundance
		186.943	CL Sundance
		187.533	WY 585 (RM 27.43); WY 585 Int. [BJH;EB, BJI;WB]
		187.646	CL Sundance
		187.783	ECL Sundance
		188.100	Machinery Pass Sep. [BJJ;EB, BJK;WB]
		188.998	US 14 (RM 203.96); East Sundance Int. [BJL;EB, BJM;WB] , Begin US 14
			E.B. Road Close Gate R/R
			Dept. Shop - Sundance SD 04A
			Sundance Rest Area CR 01S
			Sundance Port-of-Entry CR 01P
		190.437	Mach. Pass Sep. [DAM;EB, DAN;WB]
			EB C.M.Sign (dynamic)
			WB C.M.Sign (dynamic)
		191.916	Moskee Int. [DAP;EB, DAQ;WB]
		195.001	Co. Rd Overpass [DHU;EB, DHV;WB]
		197.463	Mach. Pass Sep.[DHW;EB, DHX;WB]
		199.310	WY 111 (RM 8.63); Aladdin Int. [DHY;EB, DHZ;WB] , Overpass
			Black Hills Welcome Center CR 01W
		201.478	Mach. Pass Sep.[DHJ;EB, DHK;WB]
		202.686	Mach. Pass Sep.[DHL;EB, DHM;WB]
		205.288	Rifle Pit Rd Overpass [DHN;EB,DHO;WB]
		205.346	Sand Cr. [DHP;EB, DHQ;WB]
		205.895	Beulah Int. Underpass [DHR;SS]
			Beulah Int. RWIS site {58}
		206.492	Mach. Pass Sep. [DHS;EB, DHT;WB]
	1	207.139	South Dakota State Line
			I-90 Bus.
		ML - 606B	
CR 10A	2	0.000	US 16 (RM 200.20) Mainline (NHS)
4040		0.245	I-90 (RM 154.686); E. Moorcroft Int. [BGZ;EB, BHA;WB]

Maint. Section	class	RM	US 14, 16 & I-90 Bus.
		ML - 44B	
CR 03Z	2	153.412	I-90 (RM 153.41); West Moorcroft Int. [BGV;EB, BGW;WB], Begin NHS
4040		153.548	BK= - 0.013 mi.
		153.562	AH Equation
			WY 51 (RM 152.88)
		153.928	WCL Moorcroft
CR 03A	2	154.628	BK= - 45.37 mi.
4040		200.000	AH Equation
			US 14 (RM 154.63)
			End US 14
		200.198	I-90 BUS. Spur (RM 0.00)
			End I-90 Bus.
		200.454	ECL Moorcroft
		200.510	S.B. Road Close Gate R/R
	2	210.461	Weston Co. Line
			Cont. NHS

			US 14
		ML - 607B	
CR 02A	7	154.628	US 14,16 BUS. (RM 154.63).
4040		154.970	US 14 Highway Sep.
		155.060	N.B. Road Close Gate R/R
		155.239	NCL Moorcroft
		159.670	WY 113 (RM 10.00)
		159.720	N.B. Road Close Gate R/R
		160.235	Belle Fourche Rv. [BFZ;SS]
		164.450	Lone Tree Creek [JGX;SS]
		167.260	BK= - 0.95 mi.
		168.210	AH Equation
		175.173	Carlile
CR 02B		175.850	Cabin Creek Rd (North)
4042		176.303	Cabin Cr. [FBT;SS]
		179.332	Belle Fourche Rv. [FBU;SS]
		179.684	Black Hills Nat'l. Forest Boundary
		181.050	W.B. Road Close Gate R/R
		181.140	E.B. Road Close Gate R/R
		181.190	WY 24 (RM 0.00)
		186.895	E. Black Hills Nat'l. Forest Boundary
		199.356	Taylor Divide Rd
		200.310	W.B. Road Close Gate R/R
		200.474	Unnamed Draw [DCD;SS]
		200.545	I-90 (RM 185.73); West Sundance Int. [BJD;EB, BJE;WB]
			Begin US 14 Bus. & I-90 Bus.
		200.736	WY 116 (RM 0.00)
		200.855	South Fork Sundance Cr. [BKI;SS]
		201.341	US 14 Sep.
		201.472	WCL Sundance
		201.648	South Fork Sundance Cr. [CYA;SS]
	7	201.892	North Fork Sundance Cr.

→ -cont- next column

Maint. Section	class	RM	US 14, 16 & I-90 Bus.
		ML - 607B	
		<i>(CONTINUED)</i>	
CR 02B	7	202.196	WY 585 (RM 28.05)
4042		202.654	ECL Sundance
		203.956	I-90 (RM 189.00); East Sundance Int. [BJL;EB, BJM;WB]

			US 212
		ML - 48B	
CR 05A	2	0.010	South Dakota State Line, Begin NHS
4039		2.262	Chicago Cr. [DCJ;SS]
		17.750	Little Missouri Rd (west)
		20.450	Montana State Line, End WY NHS

			WY 24
		ML - 601B	
CR 07A	7	0.000	US 14 (RM 181.19)
4039		0.743	Miller Cr. [DEC;SS]
		2.009	N. Boundary Black Hills Nat'l. Forest
		5.980	WY 110 (RM 0.00); Devils Tower Spur
		6.711	Lytle Cr. [FBQ;SS]
		14.070	S.B. Road Close Gate R/R
		14.080	Cook Lake Rd
		14.785	Belle Fourche Rv. [FFD;SS]
			SCL Hulett
		14.840	Dept. Shop - Hulett HL 04A
		15.131	WY 112 (RM 0.00)
		15.190	SCL Hulett
		15.340	BK= - 0.123 mi.
		15.463	AH Equation
		15.480	Belle Fourche Rv. [CNX;SS]
		15.948	NCL Hulett
		16.750	E.B. Road Close Gate R/R
		18.370	Bush Draw [FON;SS]
		19.793	Red Canyon Cr. [KMH;SS]
		22.949	Black Hills Nat'l. Forest Boundary
		25.460	Alva
		26.401	Beaver Cr. [KQB;SS]
		32.982	W. Boundary Black Hills Nat'l. Forest
		33.248	E. Boundary Black Hills Nat'l. Forest
		39.380	WY 111 (RM 0.00)
		39.880	Aladdin
		40.608	BK= +0.569 mi.
		40.039	AH Equation
		41.600	Oak Creek Rd
		42.100	Craco Ranch Rd
		43.972	South Fork Hay Cr. [FBI;SS]
		46.812	South Dakota State Line

Maint. Section	class	RM	WY 51
CREW			ML - 303B
CR 12A 4040	7	146.896	Campbell Co. Line
		147.041	Well Cr. [BGK;SS]
		151.667	Donkey Cr. [BGR;SS]
		152.334	Belle Fourche Rv. [KGG;SS]
		152.720	W.B. Road Close Gate R/R
	152.876	US 14,16 bus. (RM 153.56)	

			WY 110
			ML - 602B
CR 11A 4039	7	0.000	WY 24 (RM 5.98) Mainline
		0.585	Devils Tower Nat'l. Monument boundry End SHS

			WY 111
			ML - 603B
CR 08A 4042	7	0.000	WY 24 (RM 39.38)
		0.158	South Fork Hay Cr. [COE;SS]
		1.040	Unnamed Draw [JCO;SS]
		1.920	Unnamed Draw [JAT;SS]
		4.000	Upper Red Water Creek Rd (west)
		4.566	Red Water Cr. [COF;SS]
		8.500	I-90 SR ML-608B (RM 8.28)
	8.632	I-90 (RM 199.31); Aladdin Int. Overpass [DHY;EB, DHZ;WB]	

			WY 112
			ML - 604B
CR 09A 4039	7	0.000	WY 24 (RM 15.13)
		0.420	NCL Hulett
		1.290	New Haven Rd
		2.450	N.B. Road Close Gate R/R
		10.500	Seely
	29.501	Montana State Line	

			WY 113
			ML - 113B
CR 13A 4040	7	10.000	US 14 (RM 159.67) With 0.18 mi. Wye Conn.
		13.700	Wind Creek [IUF;SS]
		15.090	Jct. county Rd
		16.050	SCL Pinehaven
		16.610	End SHS @Pinehaven

			WY 116
			ML - 600B
CR 06A 4042	7	0.000	US 14 (RM 200.74)
		0.107	Sundance Cr. [CNG;SS]
		0.180	S.B. Road Close Gate R/R
		3.317	Cundy Cr. [CNH;SS]
		4.876	Beaver Cr. [BMF;SS]
		6.640	Mason Creek Rd (east)
		12.786	Inyan Kara Cr. [CNJ;SS]
	16.462	Weston Co. Line	

Maint. Section	class	RM	WY 585
CREW			ML - 2303B
CR 04A 4042	6	9.675	Weston Co. Line
		9.750	BK= - 0.11 mi.
		9.860	AH Equation
		11.200	Inyan Kara Cr. [FUX;SS]
		13.260	Soldier Cr. [FUY;SS]
		19.130	Banks Rd (west)
		22.026	Silver Cr. [FUW;SS]
		26.910	S.B. Road Close Gate R/R
		27.431	I-90 (RM 187.53); WY 585 Int.
		27.736	SCL Sundance
		27.890	Sundance Cr. [FQK;SS]
		28.000	US 14 (RM 202.20)

			I-90 SV. RD.
			ML - 608B
CR 01K 4042	9	0.000	Begin Sv. Rd. @South Dakota St. Line
		0.040	E.B. Road Close Gate R/R
		1.850	Sand Creek Bridge [FLC;NSR]
		5.870	Andy's Draw Bridge [BJR;NSR]
		8.000	<i>I-90 RM; 199.31</i> <i>Black Hills Welcome Center CR 01W</i>
		8.280	WY 111 (RM 8.50)
			I-90 (RM 199.31); Aladdin Int.
		8.750	Alkali Creek Bridge [BJQ;NSR]
		10.150	Rocky Ford Creek Bridge [BJP;NSR]
		12.780	Sundance Creek Bridge [BJO;NSR]
		16.060	Sundance Creek Bridge [BJN;NSR]
		16.900	Machinery Pass. [DAO;NSR]
		18.370	End Sv. Rd. @US 14 (RM 203.96)

			I-90 SV. RD.
			ML - 609B
CR 01N 4042	9	0.000	From Jct. I-90 (RM 189.00)
		0.080	<i>I-90 RM; 189.00</i> <i>Dept. Shop - Sundance SD 04A</i> <i>Sundance Rest Area CR 01S</i> <i>Sundance Port-of-Entry CR 01P</i>
		0.350	End Sv. Rd. @Locked Gate

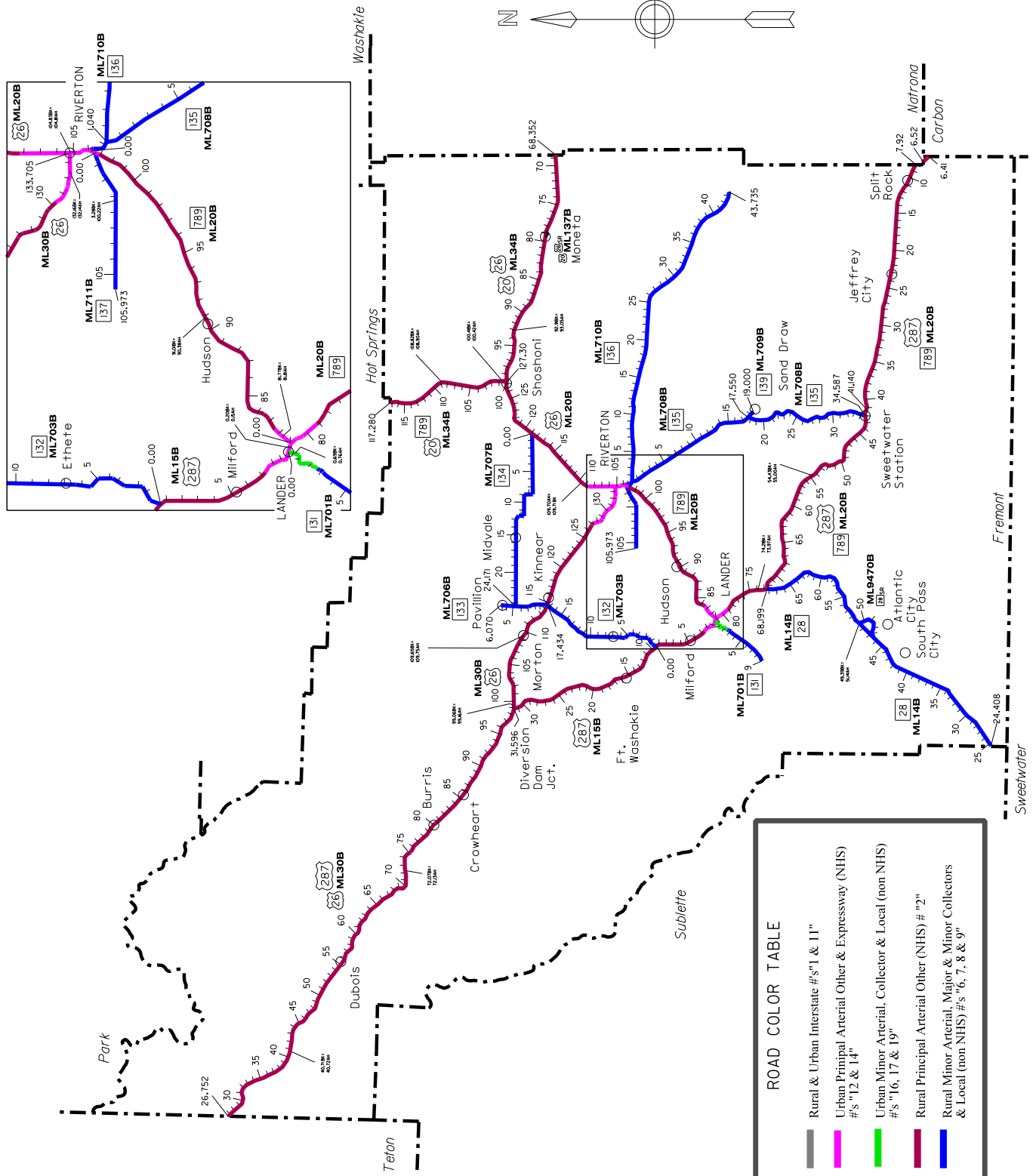
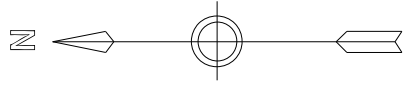

ROAD COLOR TABLE

	Rural & Urban Interstate #'s 1 & 11"
	Urban Principal Arterial Other & Expressway (NHS) #'s 12 & 14"
	Urban Minor Arterial, Collector & Local (non NHS) #'s 16, 17 & 19"
	Rural Principal Arterial Other (NHS) # "2"
	Rural Minor Arterial, Major & Minor Collectors & Local (non NHS) #'s 6, 7, 8 & 9"

Fremont

County 10

—•— class "classification break"

+ Indicates Non State System

Maint. Section	class	RM	US 20/26 & WY 789
		ML - 34B	
	2	68.352	Natrona Co. Line, Cont. NHS
FR 04A		78.780	E.B. Road Close Gate R/R
5037		79.270	Town Of Moneta
		99.070	Bonneville Rd
		99.400	RR at Grade Crossing #188783U
		99.470	Dept. Shop - Shoshoni SS 05A
		99.480	E.B. Road Close Gate R/R
		99.529	ECL Shoshoni
		100.038	US 26, WY 789 (RM 127.30) End US 26, Begin WY 789
		100.470	NCL Shoshoni
		102.711	Badwater Cr. [CBV;SS]
		102.879	BNRR Sep. [CBW;SS]
		103.140	Bonneville Rd
		103.410	N.B. Road Close Gate R/R
		108.824	BK= - 0.078 mi.
		108.902	AH Equation
		110.200	Birdseye Creek [HLL;SS]
		113.050	Boysen Camp Rd
		115.574	Wind River Indian Res. Boundary
HS 02A		116.173	Tunnel #1 [BKL;SST]
5040		116.292	Tunnel #2 [CBY;SST]
		116.392	Tunnel #3 [CBZ;SST]
	2	117.281	Hot Springs Co. Line Cont. NHS

→ -cont- in Hot springs County

Maint. Section	class	RM	US 26, US 287 & WY 789
		ML - 20B	
	2	6.412	Carbon Co. Line
		6.518	Natrona Co. Line, Cont. NHS (1.40 mi. in Natrona Co.)
FR 02A		7.917	Natrona Co. Line, Cont. NHS
2036		12.651	Cottonwood Cr. [FFF;SS]
		17.490	Unnamed Draw [FEX;SS]
		22.410	Jeffrey City (east)
		22.550	E.B. Road Close Gate R/R
		23.400	Jeffrey City (west)
		23.810	W.B. Road Close Gate R/R
		25.360	O'Brian Creek [KJL;SS]
	2	32.630	Ice Slough Cr. [FEY;SS]
		41.140	District Boundary

Maint. Section	class	RM	US 26, US 287 & WY 789
		ML - 20B	
		<i>(CONTINUED)</i>	
		41.140	District Boundary
FR 02B	2	41.622	Sweetwater Rv. [DJE;SS]
5034		41.900	Bison Basin Rd
		42.106	WY 135 (RM 34.59) Sweetwater Station Rest Area FR 10R
		42.120	E.B. Road Close Gate R/R
		46.340	Antelope Cr. [DDB;SS]
		48.140	Beaver Rim RWIS site {5}
		54.130	Old Highway
		54.286	Beaver Cr. [CXN;SS]
		54.429	BK= - 0.575 mi.
		55.004	AH Equation
		57.762	Stockdrive Overpass [BZY;SS]
		60.522	Stockdrive Overpass [BZZ;SS]
		62.066	Stockdrive Overpass [CAB;SS]
		64.045	Twin Cr. [CBS;SS]
		65.728	Twin Cr. [BTJ;SS]
		67.956	Twin Cr. [BPB;SS]
		71.810	Little Popo Agie Rv. [BTL;SS]
		72.750	E.B. Road Close Gate R/R
		72.868	WY 28 (RM 68.20)
		73.300	SB C.M.Sign (dynamic)
		73.660	Dry Lake
		74.205	BK= + 0.235 mi.
		73.970	AH Equation
		74.180	County Rd (west)
		74.350	Willow Creek Rd
	2	74.445	Willow Cr. [DED;SS]
		79.230	SUL Lander
	14		Mortimore Lane
		80.195	SCL Lander
FR 02Y		80.340	CL Lander
5034		80.470	CL Lander
		80.770	Leedy Drive
		80.940	SB C.M.Sign (dynamic)
		81.047	US 287 (RM 0.00) End US 287, Dept. Shop - Lander LD 05A Web Cam
		81.740	NCL Lander
		81.774	BK= - 0.37 mi.
FR 02C		81.811	AH Equation
5034	14	82.100	Childrens Home
		83.440	NUL Lander
	2	87.700	Lyons Valley Rd
		90.590	Little Popo Agie Rv. [DDV;SS]

→ -cont- next page

Maint. Section	class	RM	US 26, US 287 & WY 789
CREW		ML - 20B	
-cont-		<i>(CONTINUED)</i>	
FR 02C	2	90.640	WCL Hudson
5034		91.010	BK= + 0.627 mi.
		90.383	AH Equation , Cont. NHS
		90.389	Wind River Indian Res. Boundary
		90.600	ECL Hudson
		90.650	WCL Hudson
		91.315	Sweaney Draw [DAS;SS]
		91.410	Hudson Draw [GTV;SS]
		92.054	WY 138 (RM 0.00)
		92.740	Rogers & Gregg Ditch [DAX;SS]
		99.184	Beaver Cr. [DAY;SS]
		101.610	Elmwood Rd
		102.928	Little Wind Rv. [DBH;SS]
		103.484	WY 137 (RM 0.00)
		103.835	WY 135 (RM 100.00)
			Web Cam
	2	104.134	Wind Rv. [BTS;SS]
	●	104.162	SUL Riverton
→	14	104.308	SCL Riverton
		104.825	BK= + 0.012 mi.
FR 02Z		104.813	AH Equation
5042		105.169	US 26,WY 789 (RM 133.71)
			Begin US 26
		106.320	Webbwood Rd
→		106.340	CL Riverton
		107.110	Wyoming Penitentiary farm
FR 02D		107.540	Madden Draw
5042		107.790	CL Riverton
		107.930	Madden Draw [FNB;SS]
	14	107.940	NCL Riverton
	●	108.340	NUL Riverton
	2	109.010	Haymaker Draw [FNO;SS]
		109.110	Burma Rd
		109.413	BK= - 0.287 mi.
		109.700	AH Equation
		110.440	Hutchinson & Delfelders Rds
		111.203	Brown Draw [MHE;SS]
		112.210	County Rd (east & west)
		117.117	Wind River Indian Res. Boundary
→		119.040	WY 134 (RM 0.00)
		123.432	Boysen Reservoir [LCU;SS]
FR 02E		123.890	Wind River Indian Res. W. Boundary
5037		124.909	Wind River Indian Res. E. Boundary
		126.145	Poison Cr. [DDC;SS]
		126.942	WCL Shoshoni
→	2	127.299	US 20,26 ,WY 789 (RM 100.04)
			End NHS

Maint. Section	class	RM	US 26 & US 287
CREW		ML - 30B	
2		26.752	Teton Co. Line, Cont. NHS
		32.492	Brooks Lake Cr. [LVY;SS]
		33.680	Dept. Shop - Togwotee TG 05A
FR 03A		35.400	W.B. Road Close Gate R/R
5033		40.681	BK= -0.039 mi
		40.720	AH
			Shoshone Nat'l Forest Boundary
		43.384	Long Cr. [FLY;SS]
		45.663	Wind Rv. [JBN;SS]
		46.120	Union Rass Rd
		46.425	Wind Rv. [JBO;SS]
		47.860	Dunoir Rd
		49.299	Wagon Gulch Cr.
		53.250	WB C.M.Sign (dynamic)
		53.340	WCL Dubois
		54.760	Dept. Shop - Dubois DB 05A
		55.472	Horse Cr. [DHH;SS]
		56.470	ECL Dubois
		56.968	Wind Rv. [EUW;SS]
		59.200	Jakey's Fork [EUV;SS]
		60.339	N. Fork Torrey Cr. [EUV;SS]
		60.413	S. Fork Torrey Cr. [EUT;SS]
		63.671	Wind Rv. [EVB;SS]
		66.906	Wind Rv. [EVC;SS]
		67.191	Wind River Indian Res. Boundary
		69.370	Little Red Cr. [FJC;SS]
		70.450	Red Cr. [FLG;SS]
		72.070	BK= - 0.058 mi.
		72.128	AH Equation
		73.284	Dinwoody Cr. [FLR;SS]
		76.380	Dinwoody Canal [FLS;SS]
		79.440	Little Dry Creek [FJP;SS]
		79.610	Big Dry Cr. [EWN;SS]
		79.650	Burris
		84.520	Smith Draw [FJQ;SS]
		85.240	Crowheart
		86.000	Meadow Cr. [FFW;SS]
		87.140	Willow Cr. [FFX;SS]
		90.630	Sand Cr. [FFY;SS]
		91.600	Indian Creek [FGM;SS]
		95.440	Bull Lake Cr. [DZT;SS]
		96.380	Diversion Dam Rest Area FR 03R
→		98.790	US 287(RM 31.596);Diversion Dam Jct.
			End US 287
FR 03B		99.062	BK= - 0.94 mi.
5042		99.156	AH Equation
		99.650	Winchester Draw [BYU;SS]
		99.660	Old Highway
		102.810	Big Wind Rv. [BYV;SS]
		104.870	Wind River Indian Res. Boundary
		105.660	Old Highway
		109.645	BK= - 0.105 mi.
2		109.750	AH Equation

→ -cont- next page

Maint. Section	class	RM	US 26 & US 287
CREW		ML - 30B	
-cont-		<i>(CONTINUED)</i>	
FR 03B	2	110.360	Pilot Butte Reservoir Overflow [DJJ;SS]
5042		111.200	Wind River Indian Res. Boundary
		113.400	Wind River Indian Res. Boundary
		113.870	Wind River Indian Res. Boundary
		114.040	Wind River Indian Res. Boundary
		114.640	WY 132 (RM 17.43) & WY 133 (RM 0.00)
	2	124.980	Eight Mile Rd
		126.980	Service Rd (north)
	●	127.210	WUL Riverton
	14	129.070	Wind River Indian Res. Boundary
		130.390	Hill Street
		130.580	Dept. Shop - Riverton RT 05A
	→	130.670	LaClair Canal [DJD;SS] WCL Riverton
FR 03Z		130.850	College View Drive
5042		132.161	BK= + 0.025 mi.
		132.136	AH Equation
		133.020	Wyo. Central Canal #2 [BYX;SS]
		133.230	Begin Divided Section
		133.330	Third Street
	14	133.705	US 26 (RM 105.17) End NHS

US 287			
Maint. Section	class	RM	US 287
		ML - 15B	
	14	0.000	US 287 (RM 81.05) Begin NHS
FR 01Z		0.171	Middle Popo Agie Rv. [DIY;SS]
5034		0.202	BK= + 0.05 mi.
		0.152	AH Equation
		0.562	WY 131 (RM 0.00)
		1.256	Baldwin Creek Rd
		1.580	Squaw Cr. [BSJ;SS]
		1.630	Tweed Lane
	→	1.850	NCL Lander
	14	1.938	Baldwin Cr. [BSK;SS]
FR 01A	●	2.340	WUL Lander
5034	2	3.610	Steel Pipe Flume
		4.720	Milford
		5.040	Wind River Indian Res. Boundary
		5.140	Popo Agie Rv. [BSM;SS]
		8.320	Plunkett Rd
		9.279	WY 132 (RM 0.00)
		14.207	Trout Cr. [BSN;SS]
		14.680	Wind River Rd
		15.620	Fort Washakie
		16.131	Little Wind Rv. [CXM;SS]
	2	31.596	US 287 (RM 98.79) End NHS

Maint. Section	class	RM	WY 28
CREW		ML - 14B	
	6	24.408	Sublette Co. Line / District Boundary
		30.430	EB VSL sign
		34.105	Sweetwater Rv. [DLO;SS]
FR 05A		34.310	South Pass Rest Area FR 05R
5038		34.514	EB C.M.Sign (dynamic)
		35.000	EB/WB VSL sign
		38.610	South Pass County Rd
		41.350	South Pass RWIS site {3}
		43.490	Shoshone Nat'l. Forest Boundary
		44.290	Shoshone Nat'l. Forest Boundary
		44.700	W. Atlantic City Rd
		45.022	Shoshone Nat'l. Forest Boundary
		45.828	Shoshone Nat'l. Forest Boundary
		46.597	Shoshone Nat'l. Forest Boundary
		46.700	WB VSL sign
		46.910	W.B. Road Close Gate R/R
		46.920	WY 28 Loop (RM 46.73) south
		47.040	WB C.M.Sign (dynamic) EB VSL sign
		48.800	WB VSL sign
		49.050	WY 28 Loop (RM 50.17) north
		49.150	EB VSL sign
		49.337	BK= - 1.803 mi.
		51.140	AH Equation
		52.099	Beaver Cr. [FBG;SS]
		53.080	E. Shoshone Nat'l. Forest Boundary
		55.630	Johnnie Lee Spring [KMI;SS]
		58.000	EB/WB VSL sign
		59.500	Red Canyon RWIS site {4}
		62.300	WB VSL sign
		62.500	W.B. Road Close Gate R/R
		63.090	WB C.M.Sign (dynamic)
		67.211	Little Popo Agie Rv. [COL;SS]
		67.670	Red Canyon Rd
	6	68.199	US 287, WY 789 (RM 72.87)

WY 28 SV. RD.			
Maint. Section	class	RM	WY 28 SV. RD.
		ML - 9470B	
	6	46.719	WY 28 Mainline, south (RM 46.92)
FR 14A		47.521	Shoshone Nat'l. Forest Boundary
5038		48.685	Shoshone Nat'l. Forest Boundary
		49.170	E. Atlantic City Rd
		49.200	Dept. Shop - South Pass SP 05A
			W.B. Road Close Gate R/R
		50.170	WY 28 Mainline, north (RM 49.05)

Maint. Section	class	RM	WY 131
CREW			ML - 701B
	+	0.000	US 287 (RM 0.56)
		1.748	End City / Begin State
			SCL Lander
FR 06A	16	2.130	Mortimore Lane
5034	●	2.310	SUL Lander
	7	3.430	Hornecker Cr. [KMK;SS]
	7	7.115	Middle Popo Agie Rv. [BMR;SS]
	●	7.250	NUL Satellite of Lander (The Sinks)
	17		
	●	7.700	SUL Satellite of Lander (The Sinks)
	7	9.000	End SHS

Maint. Section	class	RM	WY 135
CREW			ML - 708B
	7	100.000	WY 789 (RM 103.84)
FR 10C		100.631	Little Wind Rv. [LBV;SS]
5042		101.040	BK= +1.040 mi
	→		WY 136 (RM 1.04)
	7	0.000	AH Equation
FR 10A		7.351	Wind River Indian Res. Boundary
5042		17.577	WY 139 (RM 17.55)
		17.700	S.B. Road Close Gate R/R
		34.587	US 287, WY 789 (RM 42.11)
			N.B. Road Close Gate R/R
			Sweetwater Station

Maint. Section	class	RM	WY 132
CREW			ML - 703B
	7	0.000	US 287 (RM 9.28)
		0.297	Mill Cr. [COO;SS]
FR 07A		4.690	Riverton Rd
5034		5.933	Coolidge Canal [COP;SS]
		6.978	Ethete
		7.683	Little Wind Rv. [FKK;SS]
		16.317	Wind Rv. [LZX;SS]
		16.821	Wind River Indian Res. Boundary
		17.430	US 26 (RM 114.64)

Maint. Section	class	RM	WY 136
CREW			ML - 710B
	7	1.040	WY 135 (RM 0.01)
FR 11A		1.556	Unnamed Draw [COW;SS]
		12.123	Wind River Indian Res. Boundary
5042		18.160	County Rd (north & south)
		22.600	Conant Creek [JOZ;SS]
		37.160	County Rd (north)
		43.735	End SHS

Maint. Section	class	RM	WY 133
CREW			ML - 706B
	7	0.000	US 26 (RM 114.64)
FR 08A		1.590	Pilot Canal [FOS;SS]
5037		2.360	Pilot Drain [FOT;SS]
		4.060	WY 134 (RM 24.17)
		6.070	End SHS @WCL Pavillion

Maint. Section	class	RM	WY 137
CREW			ML - 711B
	7	0.000	WY 789 (RM 103.48)
FR 12A		2.970	WY 138 (RM 8.030)
5034		2.811	BK= -97.189 mi
		100.000	AH Equation
		105.973	End SHS

Maint. Section	class	RM	WY 134
CREW			ML - 707B
	7	0.000	US 26,789 (RM 119.04)
FR 09A		1.870	County Rd (north & south)
5037		4.000	Sand Gulch [JLA;SS]
		7.820	Burma Rd
		15.571	Midvale
		24.170	WY 133 (RM 4.06)

Maint. Section	class	RM	WY 139
CREW			ML - 709B
FR 10B	7	17.545	WY 135 (RM 17.58)
5042		18.996	Sand Draw
			End SHS

Maint. Section	class	RM	US 20/26 SV. RD.
CREW			ML - 713B
FR 07J	9	0.000	US 20, 26 (RM 79.27)
5037		0.240	Town Of Moneta
		0.450	US 20, 26 (RM 78.82)

Niobrara

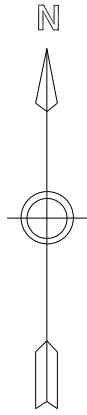

N
E
B
R
A
S
K
A

ROAD COLOR TABLE

	Rural & Urban Interstate #'s "1 & 11"
	Urban Principal Arterial Other & Expressway (NHS) #'s "12 & 14"
	Urban Minor Arterial, Collector & Local (non NHS) #'s "16, 17 & 19"
	Rural Principal Arterial Other (NHS) # "2"
	Rural Minor Arterial, Major & Minor Collectors & Local (non NHS) #'s "6, 7, 8 & 9"

Platte

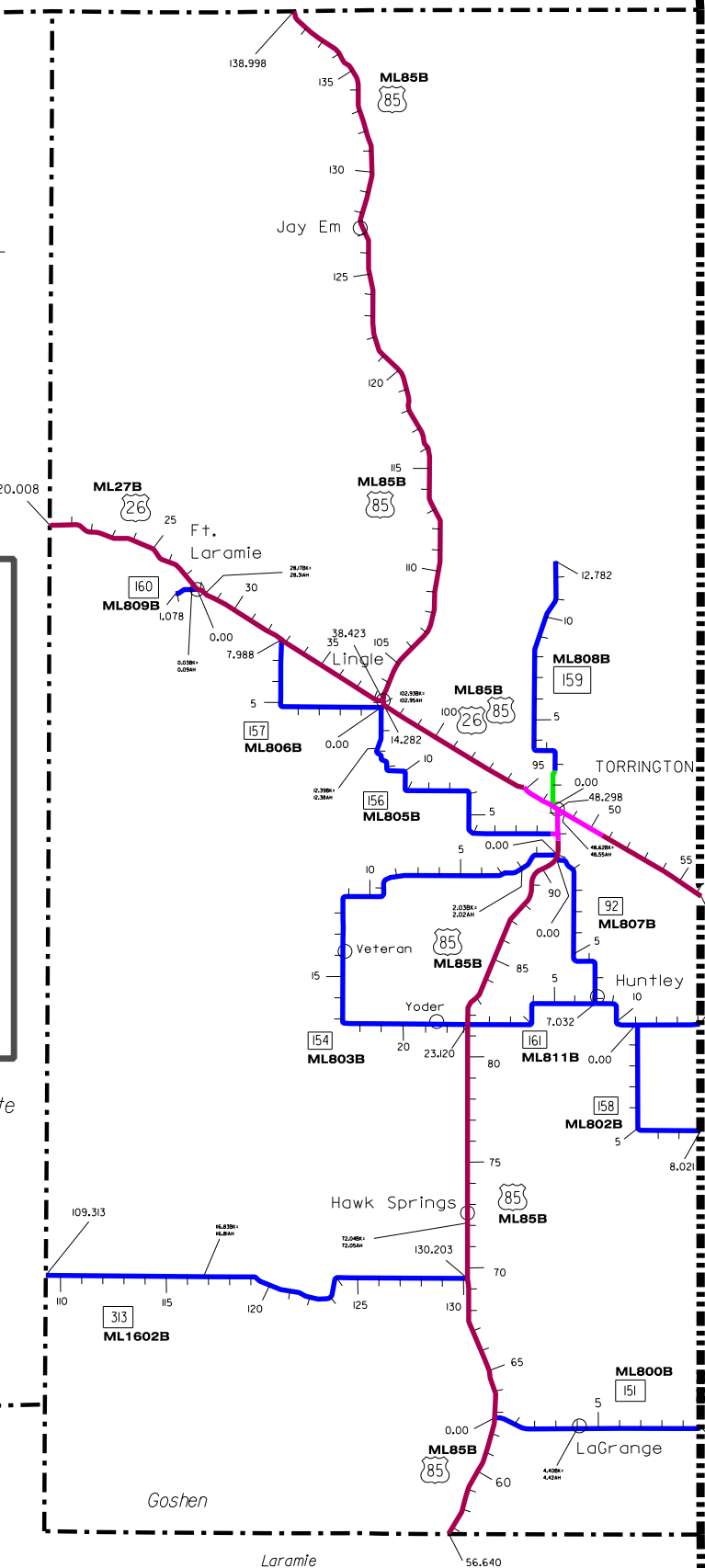

Goshen

class "classification break"

County 7

Maint. Section	class	RM	US 26
ML - 27B			
	2	20.008	Platte Co. Line
			County Line Draw [BXO;SS]
GO 02A		22.580	Cottonwood Cr. [BXP;SS]
2038		25.393	Interstate Canal [BXQ;SS]
		27.826	WCL Ft. Laramie
		27.867	WY 160 (RM 0.00)
		28.119	ECL Ft. Laramie
		28.165	BK= - 0.145 mi.
		28.310	AH Equation
		31.330	Sand Draw [BXR;SS]
		32.722	WY 157 (RM 7.99)
		37.370	County Rd (south & north)
		38.120	W.B. Road Close Gate R/R
		38.187	WCL Lingle, Begin Divided Section
	2	38.423	US 85 (RM 103.07) End Divided Section

Maint. Section	class	RM	US 26
ML - 28B			
	14	48.298	US 26,85 (RM 93.20) Cont. NHS
GO 02Z		48.616	BK= + 0.071 mi.
2038		48.545	AH Equation
		49.209	ECL Torrington
GO 02B	14	50.260	Arrowhead Rd
2038		50.710	EUL Torrington
		51.895	Torrington Prison Road
	2	56.264	Nebraska St. Line End WY NHS

Maint. Section	class	RM	US 26/85 & WY 92
ML - 85B			
	2	56.644	Laramie Co. Line / District Boundary Cont. NHS
GO 01A		62.447	Bear Cr. [BWG;SS]
2038		62.746	WY 151 (RM 0.00) S.B. Road Close Gate R/R
		69.496	WY 313 (130.20)
		72.510	RR at Grade Crossing #816466A
		72.565	Hawk Springs
		77.531	Lone Tree Cr. [BWH;SS]
		81.301	Irrigation Canal [BWI;SS]
		81.420	S.B. Road Close Gate R/R
		81.540	WY 152 (RM 0.00) & WY 161 (RM 0.00) WY 154 (RM 23.12)
		82.230	RR at Grade Crossing #816334P
	2	82.559	Springer Canal [BWJ;SS]

Maint. Section	class	RM	US 26/85 & WY 92
ML - 85B			
(CONTINUED)			
	2	88.680	S.B. Road Close Gate R/R
GO 01A		89.140	Old Highway
2038		90.825	WY 92 (RM 0.00) Begin WY 92
		91.020	WY 154 (RM 0.00)
	2	91.284	Cherry Cr. [BWK;SS]
		91.764	SUL Torrington
	14	91.870	RR at Grade Crossing #816439D
		92.018	WY 156 (RM 0.00) End WY 92
GO 01Z			SCL Torrington
2038		92.557	North Platte Rv. [JBI;SS]
		93.150	RR at Grade Crossing #089208M
		93.195	US 26 (RM 48.30) Begin US 26
		93.463	WY 159 (RM 0.00)
	14	93.628	WCL Torrington
		95.250	WUL Torrington
GO 01B	2	95.360	Torrington Port-of-Entry GO 01P
2038		97.990	Vaughn Rd
		100.330	Buttermilk Rd
		101.791	Rawhide Cr. [KMJ;SS]
		102.637	SCL Lingle
		102.850	WY 156 (RM 14.28)
		102.933	BK= - 0.013 mi.
		102.946	AH Equation
		103.070	US 26 (RM 38.42) End US 26
		103.255	NCL Lingle
		103.657	Interstate Canal [BWN;SS]
		103.830	N.B. Road Close Gate R/R
		106.760	County Rd (east)
		113.087	Unnamed Draw [BWO;SS]
		115.399	Dry Rawhide Cr. [BWP;SS]
		116.675	Rawhide Cr. [BWQ;SS]
		116.930	Six Mile Cr. [BWR;SS]
		124.064	Rawhide Cr. [DEE;SS]
		124.400	Maint. Break County Rd (west)
GO 01C		126.508	Rawhide Cr. [DEF;SS]
2035		127.360	Jay Em
	2	138.998	Niobrara Co. Line, Continue NHS

Maint. Section	class	RM	US 85 free right
OT - 813I			
GO 01K	14	0.000	US 85 (RM 93.20)
2038		0.040	US 26 (RM 43.80)

-cont- next column

Maint. Section	class	RM	WY 92
CREW			ML - 807B
	7	0.000	US 85,26 (RM 90.83)
GO 08A		7.750	RR at Grade Crossing #816323C
2038		8.288	WY 161 (RM 7.03)
		10.986	WY 158 South Spur (RM 0.00)
		13.793	Horse Cr. [CXX;SS]
		14.072	Nebraska State Line

Maint. Section	class	RM	WY 151
CREW			ML - 800B
	7	0.000	US 26,85 (RM 62.75)
GO 03A		1.447	Bear Cr. [DLR;SS]
2038		3.840	WCL LaGrange
		3.891	Horse Cr. [DLS;SS]
		4.340	ECL LaGrange
		4.402	BK= - 0.019 mi.
		4.421	AH Equation
		4.430	RR at Grade Crossing #816028X
		9.908	Nebraska State Line

Maint. Section	class	RM	WY 154
CREW			ML - 803B
	7	0.000	US 26,85 (RM 91.01)
GO 05A		1.490	County Rd (south)
2038		2.034	BK= + 0.014 mi.
		2.020	AH Equation
		4.354	Cherry Cr. [FBX;SS]
		5.660	RR at Grade Crossing #816371S
		12.906	Cherry Cr. [FBW;SS]
		13.834	Veteran
		15.647	Ft. Laramie Canal [CPC;SS]
		19.430	RR at Grade Crossing #816343N
		20.380	RR at Grade Crossing #816341A
		20.870	RR at Grade Crossing #816445G
		21.111	County Road (Old WY 152)
	*	22.130	Ft. Laramie Canal [COZ;SS]
	*	23.116	US 26,85 (RM 81.54)

* Added from WY 152 when given to County

Maint. Section	class	RM	WY 156
CREW			ML - 805B
	16	0.000	US 26,85 (RM 92.02)
		0.140	RR at Grade Crossing #906305D
GO 06A	16	0.200	RR at Grade Crossing #816442L
2038	●●	0.251	WUL Torrington
	7	6.120	County Rd (north)
		10.880	County Rd (west)
		12.119	Platte Rv. [EOY;SS]
		12.193	Platte Rv. Overflow [EOZ;SS]
		14.137	SCL Lingle
		14.156	WY 157 (RM 0.00)
		14.250	RR at Grade Crossing #089227S
		14.282	US 26,85 (RM 102.89)

Maint. Section	class	RM	WY 157
CREW			ML - 806B
	7	0.000	WY 156 (RM 14.156)
GO 07A		0.063	WCL Lingle
2038		2.000	North Platte Rv. [FEE;SS]
		4.660	County Rd (south)
		6.539	Unnamed Draw [CPG;SS]
		7.032	North Platte Rv. [FEG;SS]
		7.940	RR at Grade Crossing #089237X
		7.988	US 26 (RM 32.772)

Maint. Section	class	RM	WY 158
CREW			ML - 802B
	7	0.000	WY 92 (RM 10.986)
GO 14A		1.550	Horse Cr. [FBY;SS]
2038		8.021	Nebraska State Line

Maint. Section	class	RM	WY 159
CREW			ML - 808B
	16	0.000	US 85,26 (RM 93.46)
		0.430	27th avenue
GO 09Z		0.580	Dept. Shop - Torrington TT 02A
2038		1.430	NCL Torrington
	16	1.663	NUL Torrington
	●●		Class. Break
GO 09A	7	3.622	WY 159 (RM)
2038	●●		Class. Break
	8	4.193	County Rd (east)
		4.285	Interstate Canal [CPM;SS]
		12.782	End SHS

Maint. Section	class	RM	WY 160
CREW			ML - 809B
GO 10A	7	0.000	US 26 (RM 27.87)
2038		0.028	BK= - 0.062 mi.
		0.090	AH Equation
		0.110	RR at Grade Crossing #089243B
		0.124	WCL Ft. Laramie
		0.874	North Platte Rv. [CPN;SS]
		1.078	End SHS

Maint. Section	class	RM	WY 313
CREW			ML - 1602B
GO 15B	7	109.253	Platte Co. Line
2033		116.830	BK= + 0.02 mi.
			Maint. Brk. @ Equation
		116.810	AH Equation
GO 15A	7	130.203	US 85 (RM 69.50)
2038			W.B. Road Close Gate swing

Maint. Section	class	RM	WY 161
CREW			ML - 811B
GO 11A	7	0.000	US 85,26 (RM 81.54)
2038			& WY 152 (RM 0.00)
		2.743	Horse Cr. [CPO;SS]
		2.929	Horse Cr. [CPP;SS]
		4.329	E. Springer Lateral
		5.567	E. Springer Lateral [CPR;SS]
		6.860	E. Springer Lateral
		7.032	WY 92 (RM 8.288)

Hot Springs

class "classification break"

County 15

Maint. Section	class	RM	US 20 & WY 789	Maint. Section	class	RM	WY 120
		ML - 34B				ML - 33B	
-cont-			from Fremont County		2	0.000	US 20 (RM 132.528)
HS 02A	2	117.281	Fremont Co. Line, Cont. NHS	HS 01Z			Begin NHS
		127.393	Wind River Indian Res. Boundary	5040		0.078	End Divided Section
5040		127.480	County Rd (east)			0.939	WCL Thermopolis
		127.620	S.B. Road Close Gate R/R			3.592	Irrigation Ditch [CAK;SS]
		128.319	Big Horn Rv. [BRM;SS]	HS 01A		4.208	BK= + 0.935 mi.
		128.469	BNRR Sep. (Under) [CCB;SS]	5040		3.273	AH Equation
		129.884	WY 173 (RM 0.00)			5.150	Missouri Flat Rd
		130.200	Unnamed Draw [HLU;SS]			5.628	Owl Cr. [FBH;SS]
		130.860	Dept. Shop - Thermopolis TM 05A			8.129	WY 170 (RM 0.13)
		130.850	Begin Curb & Gutter				N.B. Road Close Gate R/R
		131.500	SCL Thermopolis			20.200	Hamilton Dome Rd
HS 02Z		132.528	Broadway Av. (RM 0.00)			20.421	Cottonwood Cr. [FLQ;SS]
5040		132.979	Hot Springs St. Park Boundary			25.779	WY 171 (RM 0.00)
		133.150	Old Dept. Shop site			25.810	Grass Cr. [FLA;SS]
		134.101	N. Boundary Hot Springs St. Park	HS 01B		32.290	WY 431 (RM 30.20)
			NCL Thermopolis	5036		33.997	Oil Draw
		135.044	Red Lane Gulch [CCC;SS]			34.510	Four Mile Rd
HS 02B		136.343	BK= + 0.012 mi.			36.723	Gooseberry Cr. [FRW;SS]
5040		136.331	AH Equation			37.100	Gooseberry Cr. Rest Area HS 01R
		137.780	County Rd (east & west)			40.490	Unnamed Draw [JRB]
		138.419	Owl Cr. [CCE;SS]			42.100	Buffalo Creek [JQY;SS]
		139.775	Unnamed Draw [CCF;SS]		2	43.100	Park Co. Line, Cont. NHS
		139.798	WY 172 (RM 0.00)				WY 170
		142.800	County Rd (west)				ML - 900B
		143.389	Coal Draw [CCG;SS]		7	0.129	WY 120 (RM 8.13)
		144.591	WY 175 (RM 0.00)	HS 03A		0.338	Unnamed Draw
		145.756	Sand Draw [CCH;SS]	5040		6.384	Shoshone Indian Res. Boundary
		146.527	Unnamed Draw [CCI;SS]			6.392	Owl Cr. [CPU;SS]
	2	147.908	Washakie Co. Line			9.743	WY 174 (RM 0.00)
			Cont. NHS			10.683	Owl Cr. [CPV;SS]
						11.646	Shoshone Indian Res. Boundary
						15.406	Hamilton Dome
							End SHS
							WY 171
							ML - 901B
				HS 04A	7	0.000	WY 120 (RM 25.67)
				5040		5.592	Spring Gulch [CPW;SS]
						8.629	Grass Cr.
							End SHS

Maint.

Section

CREW

class

RM

WY 172

ML - 902B

7	0.000	US 20 (RM 139.798)
HS 05A	0.260	RR at Grade Crossing #090474F
5040	0.781	Big Horn Rv. [CPX;SS]
	1.899	Kirby Cr. [CPY;SS]
	2.000	County Rd (north)
	2.090	Kirby Ditch [LCT;SS]
	11.263	End SHS

Maint.

Section

CREW

class

RM

WY 431

ML - 2200B

7	23.988	Washakie Co. Line
HS 07A	25.445	Gooseberry Cr. [CWY;SS]
5036	30.199	WY 120 (RM 32.29)

WY 173

ML - 903B

7	0.000	US 20 (RM 129.884)
HS 06A	0.806	BNRR Sep. [JOD;SS]
5040	1.449	Big Horn Rv. [JOE;SS]
	1.619	End SHS

WY 174

ML - 174B

8	0.000	WY 170 (RM 9.74)
HS 08A	0.597	End SHS
5040		

WY 175

ML - 904B

7	0.000	US 20 (RM 144.591)
HS 09A	0.301	WCL Kirby
5040	0.320	End SHS

	Rural & Urban Interstate #'s "1 & 11"
	Urban Principal Arterial Other & Expressway (NHS) #'s "12 & 14"
	Urban Minor Arterial, Collector & Local (non NHS) #'s "16, 17 & 19"
	Rural Principal Arterial Other (NHS) # "2"
	Rural Minor Arterial, Major & Minor Collectors & Local (non NHS) #'s "6, 7, 8 & 9"

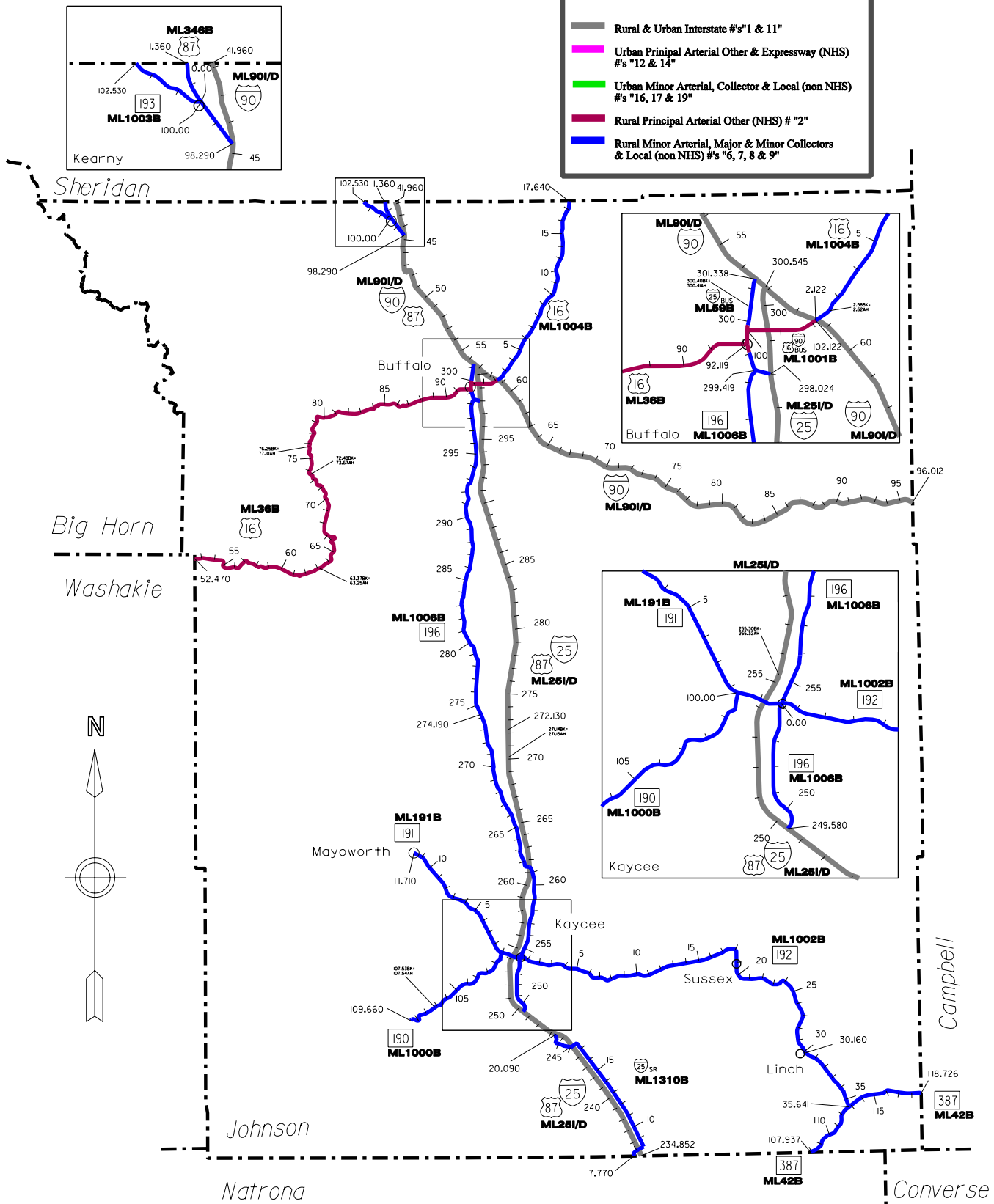

Johnson

class "classification break"

County 16

Maint. Section	class	RM	I-25 & US 87
			ML - 25
	1	234.852	Natrona Co. Line
JO 01A		235.375	Tisdale Mtn. Rd Int. [AJJ;NB, AJK;SB]
2040		241.824	Machinery Pass Sep. [AJR;NB, AJS;SB]
		244.960	Service. Rd Sep. [AJT;NB, AJU;SB]
		246.300	S. Fork Powder Rv. [AJV;NB, AJW;SB]
		246.560	Powder Rv. Int. [AJY;NB, AJZ;SB]
		247.530	Murphy Cr. [AKA;NB, AKB;SB]
		247.660	Co. Rd Sep. [AKC;NB, AKD;SB]
		249.690	WY 196 (RM 249.58); T.T.T. Int. [AKE;NB, AKF;SB]
		253.670	Barnum Rd Sep. [AKG;SS]
		253.960	Middle Fk Powder Rv. [AKH;NB, AKI;SB]
		254.130	S.B. Road Close Gate R/R
		254.250	WY 190/191 (RM 0.16); Kaycee Int. [AKJ;NB, AKK;SB]
			Kaycee Rest Area JO 01R
		254.260	N.B. Road Close Gate R/R
		255.349	BK= - 0.034 mi.
		255.315	AH Equation
		256.937	Oil Field Rd Underpass [AKL;SS]
		258.980	N. Fork Powder Rv. [AKM;NB, AKN;SB]
		261.430	US 87 Sep. [AKO;NB, AKP;SB]
		264.010	Antelope Cr. [KDS;NB, KDT;SB]
		265.476	Reno Rd Int. [AKQ;NB, AKR;SB]
		267.320	I-25 Divide RWIS site {17}
		269.216	Machinery Pass Sep. [AKS;NB, AKT;SB]
		271.877	Machinery Pass Sep. [AKU;NB, AKV;SB]
		272.130	District Boundary
		276.224	Machinery Pass Sep. [AKW;NB, AKX;SB]
JO 01B		278.262	S. Fork Crazy Woman Cr. [AKY;NB, AKZ;SB]
4036		278.836	Machinery Pass Sep. [ALA;NB, ALB;SB]
		279.564	Middle Fork Crazy Woman Cr. [ALC;NB, ALD;SB]
		280.177	Middle Fork Rd. Int. [ALE;NB, ALF;SB]
		289.550	Co. Stock Dr Overpass [ALG;NB, ALH;SB]
		291.077	Trabing Rd Int. [ALI;SS]
		291.750	Machinery Pass Sep. [ALJ;NB, ALK;SB]
		293.830	Bull Cr. [ALL;NB, ALM;SB]
		294.266	Overpass Sep. [ALN;NB, ALO;SB]
		296.271	Machinery Pass Sep. [ALP;NB, ALQ;SB]
		296.490	NB C.M.Sign (dynamic) SB C.M.Sign (dynamic)
		298.023	I-25 BUS (RM 298.02); So. Buffalo Int. [ALR;NB, ALS;SB]
			New Dept. Shop - Buffalo BF 04B
		298.200	S.B. Road Close Gate R/R
		298.564	Co. Rd Overpass Sep. [ALT;NB, ALU;SB]
	1	299.166	Clear Cr. [ALV;SS]

-cont- next column

Maint. Section	class	RM	I-25 & US 87
			ML - 25
			<i>(CONTINUED)</i>
	1	299.321	I-90 BUS (RM 100.61); Buf-Ucross Int. [ALW;NB, ALX;SB]
JO 01B		299.557	French Cr. Sep. [ALY;NB, ALZ;SB]
4036		300.563	I-90 (RM 56.85); Buff Tri-Level Int. [CQP;WBR, CQV;EB]
			I-90 & US 87
			ML - 90
			<i>from Sheridan County</i>
	1	41.958	Sheridan Co. Line
SH 01B		43.659	Piney Creek RWIS site {53}
4033		44.122	Piney Cr. [BCN;EB, BCO;WB]
		44.506	Lake DeSmet Ditch [BCP;EB, BCQ;WB]
		44.687	US 87 (RM 0.00); Piney Cr. Int. [BCR;EB, BCS;WB]
JO 03B		47.024	Machinery Pass Sep. [BCT;EB, BCU;WB]
4036		47.705	Shell Cr. Int. [BCV;EB, BCW;WB]
		48.100	Middle Fork Shell Cr [LIA;EB, LIB;WB]
		51.362	Lake DeSmet Int. [BCX;EB, BCY;WB]
		53.827	Rock Cr. Rd. Int. [BCZ;EB, CTS;WB]
		54.332	EB C.M.Sign (dynamic) WB C.M.Sign (dynamic)
		55.023	Rock Cr. Machinery Pass & Drainage Sep. [BDB;EB, BDC;WB]
		55.600	W.B. Road Close Gate R/R
		56.357	US 16.87 BUS (RM 301.34); N. Buffalo Int. [BDD;EB, BDE;WB]
		56.846	I-25 (RM 300.55) ; Buff Tri-Level Int. [CQP;WBR, CQV;EB], End US 87
		58.383	Clear Cr. [BDH;EB, BDI;WB]
		58.600	E.B. Road Close Gate R/R
		58.653	I-90 BUS (RM 102.12); US 16 Int. US 16 (RM 2.12), [BDJ;EB, BDK;WB]
		59.900	EB C.M.Sign (dynamic) WB C.M.Sign (dynamic)
		60.980	Co. Rd Sep. [BDL;EB, BDM;WB]
		63.510	Negro Cr. [BDN;EB, BDO;WB]
		65.227	Machinery Pass Sep. [BDP;EB, BDQ;WB]
		65.975	Red Hills Int. [BDR;EB, BDS;WB]
		67.391	Co. Rd Sep. [BDT;EB, BDU;WB]
		67.638	East Fork Dry Cr. [BDV;EB, BDW;WB]
		69.641	Dry Cr. Int. [BDX;EB, BDY;WB]
		73.013	Crazy Woman Int. [BDZ;EB, BEA;WB]
		73.183	Crazy Woman Cr. [BEB;EB, BEC;WB]
		75.412	Co. Rd Sep. [BED;EB, BEE;WB]
		77.914	Schoonover Rd Int. [BEF;EB, BEG;WB]
		79.293	Machinery Pass Sep. [BEH;EB, BEI;WB]

-cont- next page

Maint. Section	class	RM	I-90 & US 87
CREW			ML - 90
-cont-			(CONTINUED)
		80.238	Co. Rd Sep. [BEJ;EB, BEK;WB]
		82.828	Indian Cr. Int. [BEL;EB, BEM;WB]
		83.300	Powder River RWIS site {54}
		84.186	Co. Rd Sep. [BEN;EB, BEO;WB]
	1	85.085	Co. Rd Sep. [BEP;EB, BEQ;WB]
	1	88.673	Powder River Int. [BER;EB, BES;WB]
JO 03B			Powder River Rest Area JO 03R
4036		88.983	Powder Rv. [BET;EB, BEU;WB]
		90.801	Dead Horse Cr. [BEV;EB, BEW;WB]
		91.491	Dead Horse Int. [BEX;EB, BEY;WB]
		91.530	Dead Horse RWIS site {55}
		93.854	Co. Rd Sep. [BEZ;EB, BFA;WB]
		96.012	Campbell Co. Line

I-25/I-90 BUS & US 16/87 BUS			
ML - 59B			
JO 02A	6	298.024	I-25 (RM 298.02); South Buffalo Int. [ALR;NB, ALS;SB], Begin I-25 Bus.
4036		298.453	WY 196 (RM 299.42)
		298.668	SCL Buffalo
		298.670	Maint Break
JO 02Z	6	299.179	Clear Cr. [BMQ;SS]
4036		299.280	US 16 (RM 92.12)
	2		, Begin US 16
		299.697	I 90 BUS (RM 100.00)
	6		, Begin I-90 Bus.
			End US 16 & I-25 Bus.
		299.727	NCL Buffalo
		300.210	Old Highway
JO 02B		300.418	French Cr. [AXY;SS]
4036		301.338	I-90 (RM 56.36); N. Buffalo Int. [BDD;EB, BDE;WB]
	6		

US 16 & I-90 BUS			
ML - 36B			
			from Washakie County
-cont-		52.470	Washakie Co. Line
	2	63.270	Hazelton Rd
JO 04A		63.360	W.B. Road Close Gate R/R
4037		63.374	BK= + 0.127 mi.
		63.247	AH Equation
		69.300	Dept. Shop - Pole Creek PC 04A
		72.479	BK= - 1.191 mi.
		73.670	AH Equation
		76.245	BK= - 0.854 mi.
		77.097	AH Equation
		80.250	Maint. Break
		83.466	Big Horn Nat'l. Forest Boundary
JO 04B		85.400	EB Truck Run-Away Ramp
4036		88.200	W.B. Road Close Gate R/R
		90.830	WCL Buffalo

Maint. Section	class	RM	US 16 & I-90 BUS
CREW			ML - 36B
-cont-		91.540	Dept. Shop - Buffalo BF 04A
JO 04Z		91.570	CL Buffalo
4036		91.799	CL Buffalo
	2	92.119	I 25 BUS (RM 299.28)
			US 16 & I-90 BUS
			ML - 1001B
	2	100.000	US 16,87 BUS (RM 299.70)
JO 13Z			, Begin I-90 Bus.
4036		100.548	ECL Buffalo
		100.595	I-25 (RM 299.32); Buffalo-Ucross Int.
		100.740	French Cr. [CQQ;SS]
		101.295	W. Clear Cr. [MIA;MSS]
		101.480	Clear Cr. [MCI;SS]
		102.122	I-90 (RM 58.65) ; US 16 Int.
			, End I-90 Bus.

US 16			
ML - 1004B			
	7	2.122	I-90 (RM 58.65); US 16 Int.
JO 13A		2.262	Unnamed Draw [CQT;SS]
4036		2.300	N.B. Road Close Gate R/R
		2.582	BK= - 0.04 mi.
		2.622	AH Equation
		2.700	Kumor Road (north)
		4.895	Clear Cr. [FQH;SS]
		5.840	Road to Dam
		8.020	Watt Draw [FFO;SS]
		17.640	Sheridan Co. Line

US 87 & WY 193			
ML - 1003B			
	7	98.290	I-90 (RM 44.69); Piney Cr. Int.
SH 07A		99.650	Piney Cr. [DAA;SS]
4033		100.030	WY 346 (RM 0.00)
			, End US 87
		100.134	Piney Cr. [CQK;SS]
		100.171	Piney Cr. Overflow [IHZ;MSS]
		102.527	Sheridan Co. Line
			-cont- in Sheridan County

US 87			
ML - 346B			
SH 02C	9	0.000	US 87/WY 193 (RM 100.00)
4033		1.360	Sheridan Co. Line
			-cont- in Sheridan County

Maint. Section	RM	WY 190
		ML - 1000B
CREW	1.099	BK= - 98.901 mi.
class	7	100.000 AH Equation
JO 06A		WY 191 (RM 1.10)
2040	103.935	Alkali Cr. [LYX;SS]
	105.300	Cottonwood Cr. [LYW;SS]
	108.347	Red Fork Powder Rv. [LYV;SS]
	109.660	End SHS

Maint. Section	RM	WY 191
		ML - 191B
	0.000	WY 196 (RM 254.08)
	0.150	I-25 (RM 254.25); Kaycee Int.
class	8	Kaycee Rest Area JO 01R
JO 07A		Unnamed Draw [KQM;SS]
2040	1.099	WY 190 (RM 100.00 AH)
	5.649	N. Fork Powder Rv. [JAW;SS]
	11.710	Mayoworth

Maint. Section	RM	WY 192
		ML - 1002B
	0.000	WY 196 (RM 254.08) & WY 191 (RM 0.00)
class	7	0.150 Dept. Shop Kaycee KC 02A
JO 08B		0.500 E.B. Road Close Gate swing
2040	4.382	N. Fork Powder Rv. [CQF;SS]
	9.967	15 Mile Draw [JOF;SS]
	19.606	Powder Rv. [CQH;SS]
	19.641	Sussex
	20.707	Coal Cr. [CQI;SS]
	21.097	Carpenter Cr. [CQJ;SS]
	30.164	Linch
	35.600	W.B. Road Close Gate swing
	35.641	WY 387 (RM 112.791)

Maint. Section	RM	WY 387
		ML - 42B
class	7	0.150 Dept. Shop Kaycee KC 02A
JO 08A		0.500 E.B. Road Close Gate swing
2037	4.382	N. Fork Powder Rv. [CQF;SS]
	9.967	15 Mile Draw [JOF;SS]
	19.606	Powder Rv. [CQH;SS]
	19.641	Sussex
	20.707	Coal Cr. [CQI;SS]
	21.097	Carpenter Cr. [CQJ;SS]
	30.164	Linch
	35.600	W.B. Road Close Gate swing
	35.641	WY 387 (RM 112.791)

Maint. Section	RM	WY 196
		ML - 1006B
CREW	7	249.580 I-25 (RM 249.69); T.T.T. Int.
class	7	[AKE;NB, AKF;SB]
JO 12A		253.100 S.B. Road Close Gate swing
2040	253.617	Middle Fork Powder Rv. [DCE;SS]
	253.690	SCL Kaycee
	254.004	NCL Kaycee
	254.082	WY 191 (RM 0.00) & WY 192 (RM 0.00)
	254.300	N.B. Road Close Gate swing
	258.025	North Fork Powder Rv. [COQ;SS]
	261.430	US 87 Sep. (I-25)
	264.180	Antelope Creek [JSZ;SS]
	270.157	Unnamed Draw
	273.377	S. Fork Crazy Woman Cr. [FMB;SS]
	274.191	Beaver Cr. [FMC;SS] District Boundary
JO 12B		278.842 Middle Fork Crazy Woman Cr. [FMD;SS]
4036	284.713	Muddy Cr. [FHJ;SS]
	287.630	N. Fork Crazy Woman Cr. [FHU;SS]
	294.589	Bull Cr. [FKO;SS]
	297.040	County Rd (west)
	298.297	Steel Flume
	298.820	Steel Flume
class	7	299.419 I 25 BUS (RM 298.45)

Maint. Section	RM	WY 387
		ML - 42B
class	6	107.937 Natrona Co. Line
JO 05A		111.369 Meadow Cr. [CGS;SS]
2037	112.791	WY 192 (RM 35.64)
	116.846	J. J. Draw [DIU;SS]
	118.726	Campbell Co. Line

Maint. Section	RM	I-25 SV. RD.
		ML - 1310B
class	9	7.770 Natrona Co. Line
JO 01K		8.370 I-25 (RM 235.38) Tisdale Int.
2040	8	[AJJ;NB, AJK;SB] Class. Break
	18.100	I-25 (RM 244.96), Service. Rd Sep. [AJT;NB, AJU;SB]
	19.420	Bridge Powder Rv. [AJX;WSR]
class	8	20.090 I-25 (RM 246.56); Powder River Int.
		[AJY;NB, AJZ;SB] End Sv. Rd.

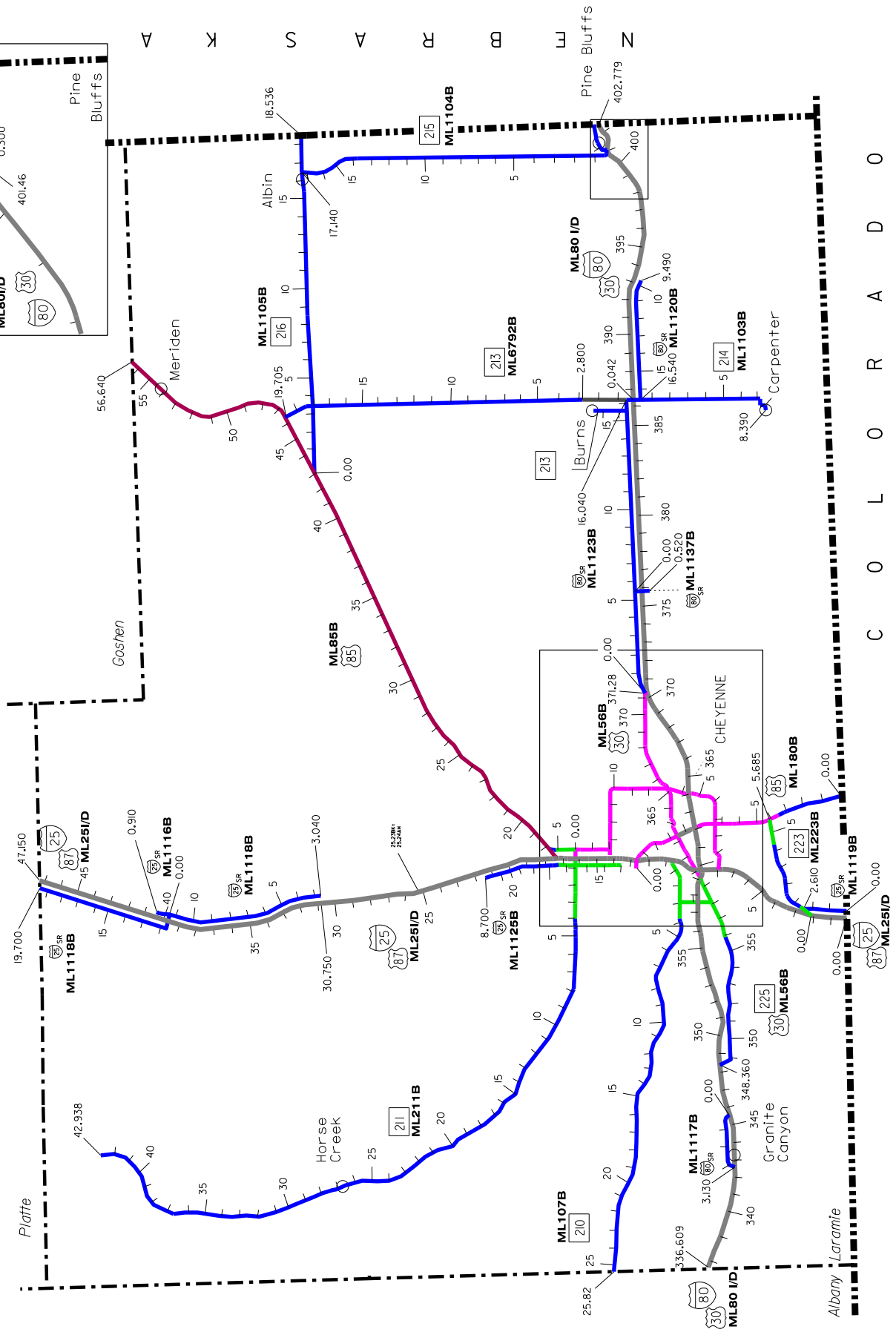
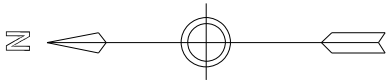
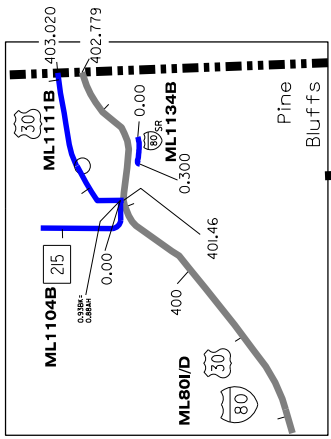

ROAD COLOR TABLE

- Rural & Urban Interstate #'s "1 & 11"
- Urban Principal Arterial Other & Expressway (NHS) #'s "12 & 14"
- Urban Minor Arterial, Collector & Local (non NHS) #'s "16, 17 & 19"
- Rural Principal Arterial Other (NHS) # "2"
- Rural Minor Arterial, Major & Minor Collectors & Local (non NHS) #'s "6, 7, 8 & 9"

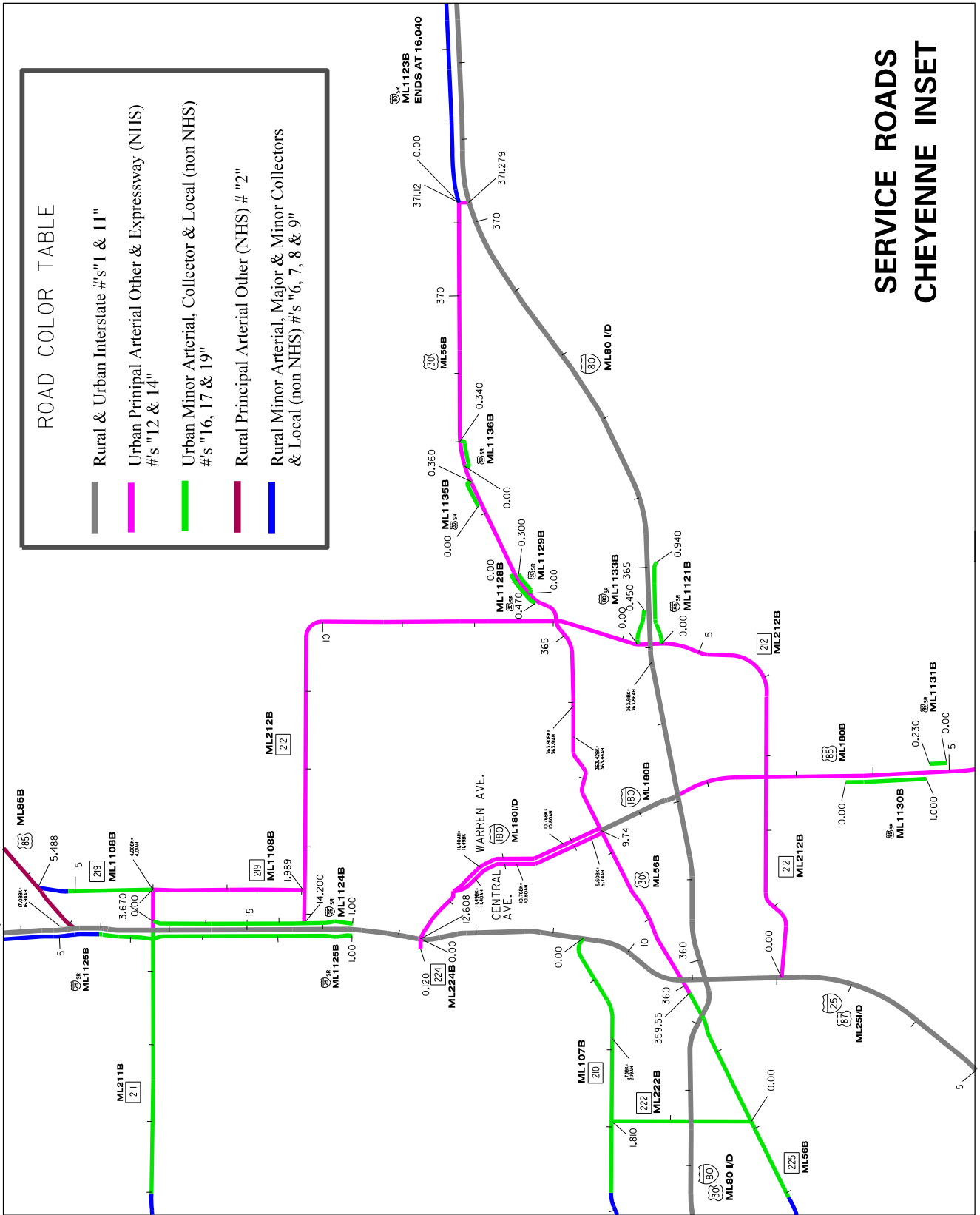

SERVICE ROADS CHEYENNE INSET

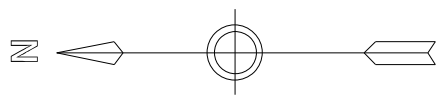

Laramie

class "classification break"

County 2

Maint. Section	class	RM	I-25 & US 87/85	Maint. Section	class	RM	I-25 & US 87
CREW		ML - 25		CREW		ML - 25	
	11	0.000	Colorado State Line				(CONTINUED)
		0.389	Machinery Pass Sep. [AAA;NB, AAB;SB]			14.354	NCL Cheyenne
		0.971	Duck Cr. [AAC;SS]	LA 03A		14.700	NB C.M. Sign (dynamic)
LA 03A		1.240	NB C.M. Sign (dynamic)	1034			SB C.M. Sign (dynamic)
1034		1.564	Lone Tree Cr. [AAE;SS]			16.230	WY 211 (RM 0.51); Iron Mountain Int.
		2.600	N.B. Road Close Gate R/R		11		[CRB;SS] NUL Cheyenne
		2.662	WY 223 (RM 0.00); Terry Rd Int.			17.236	US 85 (RM 16.939); Torrington Int.
			[AAG;NB, AAH;SB]	1			[ABQ;NB], End US 85
		3.289	UPRR Sep. (Under) [AAI;NB, AAJ;SB]			18.800	N.B. Road Close Gate R/R
			Wyo Hill (1) RWIS site {9}			19.255	Co. Rd Overpass [ABR;NB,ABS;SB]
		3.150	NB C.M. Sign (blankout)			21.318	Ridley Rd Int. [ABT;SS]
		3.340	SB C.M. Sign (blankout)			22.737	Machinery Pass Sep. [ABU;NB, ABV;SB]
		3.520	Wyo Hill (2) RWIS site {10}			23.657	Lodge Pole Cr. [ABW;NB, ABX;SB]
		3.850	NB C.M. Sign (blankout)			25.452	Missile Site "A" Int. [ABY;SS]
		4.016	C&S RR Co. Rd Sep. (Under)			28.152	Whitaker RWIS site {12}
			[AAK;NB, AAL;SB]			29.512	Whitaker Rd Int. [ABZ;SS]
			Wyo Hill (3) RWIS site {11}			30.750	District Boundary
		4.230	SB C.M. Sign (blankout)			31.024	Machinery Pass Sep. [ACA;NB, ACB;SB]
		4.774	Co. Rd. (RM 0.00); High Plains Int.	LA 03B		33.098	Machinery Pass Sep. [ACC;NB, ACD;SB]
			[MFT;SS]	2033		33.227	Horse Cr. [ACE;NB, ACF;SB]
			SE Welcome Center LA 03W			34.443	Nimmo Rd Int. [ACH;SS]
		4.900	S.B. Road Close Gate R/R			35.799	Little Bear Cr. [ACI;NB, ACJ;SB]
		5.940	SB C.M. Sign (dynamic)			37.663	Co. Rd Sep. [ACL;NB, ACM;SB]
		6.350	Port-of-Entry (N.B.) LA 03P			39.235	Indian Hills Int. [ACN;NB, ACO;SB]
		7.030	SUL Cheyenne			40.515	South Fork Bear Cr. [DCM;NB, DCN;SB]
		7.853	WY 212 (RM 0.00); College Drive Int.			41.836	Middle Fork Bear Cr. [DCO;NB, DCP;SB]
			[KEF;SS]			43.661	North Fork Bear Cr. [DCQ;NB, DCR;SB]
		8.090	S.B. Road Close Gate R/R			45.211	Cantler Draw [DCS;NB, DCT;SB]
		8.440	Clear Cr. [AAN;NB, AAO;SB]			46.149	Co. Rd Overpass [DCU;NB, DCV;SB]
		8.844	I-80 (RM 359.60) I-25 & I-80 Int			46.770	Bear Cr. RWIS site {76}
			[AAR;NB, AAS;SB]		1	47.151	Platte Co. Line
		9.143	US 30 (RM 360.10); UPRR & US 30 Int.				
			[AAV;NB, AAW;SB]				
		10.026	Military Reservation Boundary				
		10.373	Crow Cr. [AAY;NB, AAZ;SB]				
		10.586	Missile Drive Int. [ABB;NB, ABC;SB]				
		10.779	BNRR Sep. (Under) [ABE;NB, ABF;SB]				
		11.239	Randall Avenue Int. [MCJ;NB, MCK;SB]				
		12.120	SCL Cheyenne				
		12.134	Military Reservation Boundary				
		12.146	Country Club Rd Sep. [ABK;SS]				
		12.238	Lake Absaraca [ABL;NB, ABM;SB]				
		12.299	Lake Absaraca [ABN;NB, ABO;SB]				
		12.697	US 85 (RM 12.61); Central Avenue Int.				
			[EOI;SS], & WY 224 (RM 0.00)				
			, Begin US 85,				
			Headquarters Cheyenne HQ 01A				
		13.230	Western Hills Ped. Overpass [DFQ;SS]				
11		13.834	Vandehei Int. [ABP;SS]				

-cont- next column

Maint. Section	class	RM	I-80 & US 30
CREW		ML - 80	
	1	336.609	Albany County Line
		338.100	WB VSL sign
LA 01A		339.318	Remount Int. [AYB;EB, AYC;WB]
1035		339.860	EB VSL sign
		340.500	Remount RWIS site {50}
		340.649	UPRR Ozone Sep. (Under)
			[AYD;EB, AYE;WB]
		341.010	EB C.M.Sign (dynamic)
		341.600	WB VSL sign
		342.559	CO. RD. (RM 0.00); Harriman Int.
			[AYF;EB, AYG;WB]
		343.240	EB VSL sign
		343.670	WB C.M.Sign (dynamic)
		344.690	WB VSL sign
		345.500	Warren Int. [AYH;EB, AYI;WB]
		345.900	EB VSL sign
		346.404	UPRR Otto Sep.(Under) [AYJ;EB, AYK;WB]
		347.690	WB VSL sign
			Otto Road RWIS site {70}
		348.363	WY 225 (RM 348.36); Otto Int.
			[AYL;EB, AYM;WB]
		349.150	EB VSL sign
		353.000	WB VSL sign
			RM 353 RWIS site {71}
		353.990	Co. Rd Sep. [AYN;EB, AYO;WB]
		355.210	Co. Rd Sep. [AYP;EB, AYQ;WB]
●		356.190	WB C.M.Sign (dynamic)
11		356.740	WUL Cheyenne
		357.677	WY 222 (RM .79) RoundTop Int.
			[AYR;EB, AYS;WB]
		357.900	W.B. Road Close Gate R/R
		359.089	WY 225 (RM 359.55); Lincolnway Int.
			[AYU;EB, AYW;WB]
		359.599	I-25 (RM 8.84); I-25 & I-80 Int.
			[AAR;NB, AAS;SB]
		359.992	S.W. Drive Sep. [AYZ;EB, AZA;WB]
		360.160	Unnamed Draw [AZB;SS]
		360.386	BNRR Sep. (Under) [DJY;SS]
		360.410	WCL Cheyenne
		360.775	Parsley Blvd. Sep. [AZD;SS]
		361.033	Cribbon Ave Ped. Overpass [AZE;SS]
		361.791	Walterscheid. Sep.
			[AZF;EB, AZG;WB, AZH;WBR]
		362.000	CL Cheyenne
		362.037	US 85 (RM 8.50) & I-180; US 85 Int.
			[AZI;EB, AZJ;WB]
		362.649	Morrie Rd Sep. [ADR;EB, CBG;WB]
		363.750	E.B. Road Close Gate R/R
		363.910	BK= + 0.053 mi.
		363.857	AH Equation

→ -cont- next column

Maint. Section	class	RM	I-80 & US 30
CREW		ML - 80	
			(CONTINUED)
		363.869	Crow Cr.
			[DBZ;EB, DCA;WB, DCB;EBR, DCC;WBR]
		364.000	WY 212 (RM 5.62); Sun Valley Int.
			[DBW;SS]
		364.310	CL Cheyenne
LA 01A		364.800	ECL Cheyenne
1035		364.999	BNRR Sep. (Under) [DBN;EB, DBO;WB]
		367.424	Campstool Rd Int. [DBR;EB, DBS;WB]
		370.100	E.B. Road Close Gate R/R
		370.394	US 30 (RM 371.28); Archer Int.
	11		[CGC;SS]
	●	371.410	EUL Cheyenne
	1	371.890	W.B. Port-of-Entry LA 01P
		373.000	WB C.M.Sign (dynamic)
			RWIS site {72}
		375.379	Co. Rd Sep. [AZP;EB, AZQ;WB]
	→	377.350	CO. RD. (RM 0.00); Hillsdale Int.
			[AZR;EB, AZS;WB]
LA 01B		380.360	Co. Rd Sep. [AZT;EB, AZU;WB]
1039		383.356	Co. Rd Sep. [AZV;EB, AZW;WB]
		385.847	Unnamed Draw [AZX;EB, AZY;WB]
		386.389	WY 213 (RM 0.00); Burns-Carpenter Int.
			[AZZ;EB, BAA;WB]
			& WY 214 (RM 0.00)
		388.058	Unnamed Draw [BAB;SS]
		391.385	Egbert Int. [BAD;EB, BAE;WB]
		396.443	Co. Rd Sep. [BAF;EB, BAG;WB]
		400.580	Co. Rd Sep. [BAH;EB, BAI;WB]
		401.116	WCL Pine Bluffs
		401.164	Muddy Cr. [BAJ;EB, BAK;WB]
		401.200	E.B. Road Close Gate R/R
		401.300	W.B. Road Close Gate R/R
		401.456	US 30 (RM 401.46); West Pine Bluffs Int.
			[BAM;EB, BAN;WB]
			Pine Bluffs Rest Area LA 01R
		402.143	Beech Street Sep. [BAO;EB, BAP;WB]
		402.778	ECL Pine Bluffs
	1		Nebraska State Line

Maint. Section	class	RM	US 30 & WY 225
			ML - 56B
LA 02A	8	348.360	I-80 (RM 348.36); Otto Int. [AYJ;EB, AYK;WB]
1035			E.B. Road Close Gate swing
	8		W.B. Road Close Gate swing
	●	355.980	WUL Cheyenne
	17	358.014	WY 222 (RM 0.00)
		359.202	Begin Divided Section
	17		Begin 4-lane
	●	359.480	I-80 (RM 359.08); Lincolnway Int. [AYU;EB, AYS;WB], End WY 225
	14		Begin US 30 & I-80 Bus.
		360.098	I-25 (RM 9.14) UPRR & US 30 Sep.
		360.750	Cutler Rd.
		360.843	Westland Rd. End Divided Section
		360.890	BNRR Sep. (Under)
	→	361.173	WCL Cheyenne
		361.510	Missile Dr.
LA 02Z		361.541	Crow Cr. [FJK;SS]
1035		361.830	RR at Grade Crossing #245696X
		362.280	US 85 (RM 9.74); Central Ave.
		362.345	US 85 (RM 9.74); Warren Ave.
		363.187	Dunn Ave.
		363.320	Hugar Ave.
		363.385	Logan Ave.
		363.421	BK= - 0.015 mi. Big Horn Ave.
		363.436	AH Equation
		363.643	Converse Ave.
		363.909	Hot Springs Ave.
LA 02Z		364.785	Ridge Rd
1035		365.230	WY 212 (RM 6.88) End I-80 Bus.
	→	365.630	ECL Cheyenne
		366.109	Dry Cr. [AZL;SS]
LA 02B		366.701	End 4- lane
1035		367.930	Del Range Blvd.
		370.731	UPRR Sep. (Under) [AZO;SS]
	14	371.279	I-80 (RM 370.39); Archer Int. Underpass [CGC;SS]

Maint. Section	class	RM	US 85, US 87 BUS, I-180 & I-25 BUS
			ML - 180B
	6	0.000	Colorado State Line
	6	3.200	Chalk Bluffs Rd.
LA 05A	●	3.540	SUL Cheyenne
1035	14	3.801	Begin Divided Section
		4.116	WY 223 (RM 5.69)
			Cheyenne Port-of-Entry LA 05P
		4.130	S.B. Road Close Gate swing
		5.810	End Divided Section
		6.298	Wallick Rd.
		7.307	WY 212 (RM 2.71) Begin I-25 Bus.
		7.740	Allison Draw [JBH;SS]
		8.338	CO. RD. (RM 0.00) Begin Divided Section
		8.508	I-80 (RM 362.04); US 85 Int. Begin I-180 & US 87 Bus.
	14		Begin NHS
	→	8.510	SCL Cheyenne
	11	8.669	Deming Drive Sep. [DER;SS]
LA 05Z		8.717	Crow Cr. [DEP;SS]
1035		8.850	5th Street
		8.975	Pedestrian Overpass [DEO;SS]
		9.120	9th Street
		9.374	UPRR Sep. (Under) [EAI;NB, EAJ;SB]
	11	9.595	BK= -0.145 mi.
	●	9.740	AH Equation
	14		End I-180, End NHS
	14	9.740	US 30 (RM 362.35); Lincolnway
LA 05Z		10.676	Pershing Blvd.
1035		10.758	BK= -0.045
		10.803	AH Equation
		11.220	8th Ave.
		11.445	BK= + 0.046 mi.
		11.399	AH Equation
		11.790	WY 219 (RM 0.00) Yellowstone Ave.
	14	12.610	I-25 (RM 12.70); Central Avenue Int. WY 224 (RM 0.00), End I-25 & 87 Bus.

US 30			
<i>Pine Bluffs City Route</i>			
Maint. Section	class	RM	
			ML - 1111B
LA 22A	7	401.460	I-80 (RM 401.46); West Pine Bluffs Int. [BAM;EB, BAN;WB]
1039		401.522	WY 215 (RM 0.00)
		402.670	Dept. Shop - Pine Bluffs PB 01A south on Walnut St.
		403.017	Nebraska State Line

Maint. Section	class	RM	US 85
CREW		ML - 85B	
	2	16.939	I-25 (RM 17.24); Torrington Int.[ABQ;NB] Begin NHS
LA 05B		17.290	End Divided Section
1034		17.651	WY 219 (RM 5.49)
		17.790	N.B. Road Close Gate swing
		23.757	Lodgepole Cr. [FFH;SS]
		43.016	WY 216 (RM 0.00)
		46.500	Gun Barrel RWIS site {51}
		46.690	WY 213 (RM 19.705)
		52.587	Little Horse Cr. [BWE;SS]
		53.800	Meriden Rest Area LA 05R
		54.149	Horse Cr. [BWF;SS]
		54.220	Meriden
		56.644	Goshen Co. Line / District Boundary
	2		Cont. NHS

			WY 210
		ML - 107B	
	16	0.000	I-25 (RM 10.59)
LA 06A		0.160	Missile Drive to Warren Gate #2
1035		0.230	Crow Cr. [FLF;SS]
		1.727	BK= - 0.467 mi.
		2.194	AH and FE Warren AFB Boundary
		2.941	WY 222 (RM 1.81)
	16	2.950	W.B. Road Close Gate R/R
	●	3.920	UL Cheyenne
	7	4.320	Diamond Cr. [LMQ;SS]
		9.700	Unnamed Draw [CIZ;SS]
		14.416	Crystal Lake Rd.
		23.860	Granite Res. Rd.
		24.600	W.B. Road Close Gate swing
	7	25.815	Albany Co. Line

			WY 211
		ML - 211B	
	14	0.000	WY 219 (RM 4.01)
	●	0.510	I-25 (RM 16.23); Iron Mountain Int.
LA 07A	17		[CRB;SS]
1034	17	3.790	WY 222 (RM 8.29); Round Top Rd.
	●	4.070	UL Cheyenne
	7	9.260	Unnamed Draw [CRC;SS]
		17.030	RR at Grade Crossing #245526D
		17.291	S. Fork Lodgepole Cr. [CRD;SS]
		20.455	Middle Fork Lodgepole Cr. [CRE;SS]
		20.760	RR at Grade Crossing #245528S
		20.827	Dry Draw [CRF;SS]
		25.098	Dry Horse Cr. [CRG;SS]
		26.557	S. Fork Horse Cr. [CRH;SS]
		26.676	Horse Creek Townsite
		27.236	Horse Cr. [CRI;SS]
		42.600	RR at Grade Crossing #245662D
		42.690	Chugwater Cr. [DDL;SS]
	7	42.938	End SHS

Maint. Section	class	RM	WY 212 & I-25 BUS
CREW		ML - 212B	
	14	0.050	I-25 (RM 7.85);College Dr. Int.[KEF;SS]
LA 08A		0.250	Southwest Drive
1034		0.660	RR at Grade Crossing #245617J
		0.980	BK= 0.099 mi.
		0.881	AH Equation
		1.220	Parsley Blvd.
		2.230	Walterschied Rd.
		2.350	Allison Draw [KSA;SS]
		2.705	US 85 (RM 7.31) End I-25 bus
		3.250	Avenue "C"
		4.003	LCCC College
		4.520	Allison Draw [KSG;SS]
		5.094	Fox farm Rd. (RM 1.84)
		5.381	Crow Cr. [DBV;SS]
		5.622	I-80(RM 364.00);Sun Valley Int.[DBW;SS]
		5.951	UP & BNRR Sep. (Under) [DBX;SS]
		6.040	Henderson Ditch [DBY;SS]
		6.100	SCL Cheyenne
		6.509	12th Street
		6.875	US 30 (RM 365.23)
		7.148	Pershing Blvd.
		7.932	Dry Cr. [DEV;SS]
		8.147	Dell Range Blvd.
		8.160	CL Cheyenne
		8.270	CL Cheyenne
		8.370	NCL Cheyenne
		10.430	Ridge Rd.
		12.050	Powder House Rd.
		13.567	WY 219 (RM 2.00)
		14.200	I-25 SR ML1124B (RM 1.66)

Maint. Section	class	RM	WY 213
CREW			ML - 6792B
	7	0.000	I-80 (RM 386.39); Burns-Carpenter Int. [AZZ;EB, BAA;WB] & WY 214 (RM 0.00)
		0.100	I-80 SR ML1123B (RM 16.040)
		1.050	County Rd #212
		1.595	CL Burns
		2.089	County Rd #213
		2.224	East 3rd St.
		2.348	East 2nd St.
		2.604	UPRR Bridge [MDM;SS]
	7	3.050	CL Burns (Louth Rd)
		4.042	County Rd 215 (Hillsdale Ridge Rd)
LA 23A		4.567	Lodgepole Cr. [DOT;SS]
1039		5.038	County Rd 216 (Landfill Rd)
		6.036	County Rd 217 (Martin Rd)
		6.180	Unnamed Draw
		6.910	Spring Cr
		7.033	County Rd 218 (Deselms Rd)
		8.030	County Rd 219 (Lyon Rd)
		8.770	Unnamed Draw
		9.027	County Rd 220 (Anderson Rd)
		9.440	Antelope Draw
		11.029	County Rd 222 (King Rd)
		13.030	Chivington Draw
		14.019	County Rd 225 (Ogle Rd)
		15.018	County Rd 226 (Golden Prairie Rd)
		16.056	County Rd 227
	7	17.085	County Rd 228
	●	18.085	WY 216 (RM 3.85) & Class. Break
	8	19.705	US 85 (RM 46.69)

Maint. Section	class	RM	WY 214
CREW			ML - 1103B
	7	0.000	I-80 (RM 386.39); Burns-Carpenter Int. [AZZ;EB, BAA;WB] & WY 213 (RM 0.00)
LA 10A		0.212	Unnamed Draw
1039		2.123	Unnamed Draw [CRM;SS]
		2.870	Unnamed Draw [MFA;SS]
		4.340	Unnamed Draw [MFB;SS]
		8.334	Carpenter
		8.394	End SHS

Maint. Section	class	RM	WY 215
CREW			ML - 1104B
	7	0.000	US 30 (RM 401.52)
LA 11A		0.219	UPRR Sep. (Under) [FBF;SS]
1039		0.934	BK= + 0.05 mi.
		0.884	AH Equation
		0.893	Lodgepole Cr. [CRN;SS]
		1.671	Spring Cr. [CRO;SS]
		1.798	NCL Pine Bluffs
		10.030	Unnamed Draw [JZA;SS]
		13.160	Unnamed Draw [CRP;SS]
		15.860	Unnamed Draw
		17.140	WY 216 (RM 16.47)

Maint. Section	class	RM	WY 216
CREW			ML - 1105B
	7	0.000	US 85 (RM 43.02)
LA 12A		3.850	WY 213 (RM 18.09)
1039		15.828	WCL Albin
		16.150	RR at Grade Crossing #816056B
	7	16.180	ECL Albin
	●	16.465	WY 215 (RM 17.14)
	8	18.536	Nebraska State Line

Maint. Section	class	RM	WY 219
CREW			ML - 1108B
	14	1.989	End City, County / Begin State
LA 15A		1.990	WY 212 (RM 13.57); Four Mile Rd
1034	14	3.000	Riding Club Rd.
	16	4.007	WY 211 (RM 0.00)
	●	5.010	NUL Cheyenne
	7	5.480	US 85 (RM 17.65)

Maint. Section	class	RM	WY 222
CREW			ML - 222B
	17	0.000	US 30/WY 225 (RM 358.01)
LA 17A		0.779	I-80 (RM 357.68) RoundTop Int.
1035		1.812	WY 210 (RM 2.941) End SHS

Maint. Section	class	RM	WY 223
CREW			ML - 223B
	17	0.000	I-25 (RM 2.66); Terry Ranch Rd Int.
LA 18A		0.260	Service Rd Right
1035	●	0.640	Class Break
	7	0.858	UPRR Sep. (Under) [CYD;SS]
	●	4.000	S.B. Road Close Gate swing
	●	4.030	WUL Cheyenne
	17	5.685	US 85 (RM 4.12)

Maint. Section	class	RM	WY 224
CREW			ML - 224B
LA 19A	14	0.000	I-25 (RM 12.70) (NHS) & US 85 (RM 12.61)
1034		0.050	Bishop Blvd.
		0.119	FE Warren AFB Boundary End SHS, & NHS, Cheyenne Headquarters HQ 01A

I-25 SV. RD.			
ML - 1116B			
LA 03T	9	0.000	ML 1118 (RM 11.49)
2033		0.910	End Sv. Rd. @County Rd. <i>north of Interchange</i>

I-25 SV. RD.			
ML - 1118B			
LA 03K	9	3.040	District Boundary
2033		5.600	Horse Creek [ACG;ESR]
		8.230	Little Bear Cr. [ACK;ESR]
		11.490	ML 1116
		11.670	I-25 (RM 39.24)Indian Hills Int. N.
		12.960	S. Fork Bear Cr. [ACP;WSR]
		14.310	Middle Fork Bear Cr. [ACQ;WSR]
		16.150	N. Fork Bear Cr. [ACR;WSR]
		17.760	Cantel Draw [ACS;WSR]
	9	19.700	Platte Co. Line

I-25 SV. RD.			
ML - 1119B			
LA 03J	9	0.000	From Colo. State Line
1034		0.970	Duck Cr.
		1.570	Lone Tree Cr.
		2.610	WY 223 (RM 0.26); Terry Rd. Int.

I-25 SV. RD.			
ML - 1124B			
LA 03Q	17	1.000	end city/begin state
1034		1.080	Vandehei Av.
		1.650	NCL Cheyenne
		1.660	WY 212 (RM 14.20)
		3.710	NUL Cheyenne
			WY 211 (RM 0.46)

I-25 SV. RD.			
ML - 1125B			
LA 03N	17	1.000	end city/begin state
1034		1.143	Vandehei Av.
		1.800	NCL Cheyenne
	17	3.568	WY 211 (RM 0.50)
	●	4.879	NUL Cheyenne
	8	8.700	County Rd (Ridley Rd. Int)

Maint. Section	class	RM	I-80 SV. RD.
CREW			ML - 1117B
LA 01J	9	0.000	I-80 (RM 345.50) Warren Int.
1035		3.130	End Sv. Rd. Jct. Harriman Int. (I-80 RM 342.56)

I-80 SV. RD.			
ML - 1120B			
LA 01L	9	9.490	Begin Sv. Rd. @end Co. Rd
1039		14.790	Bridge
		16.540	WY 214 (RM 0.10)

I-80 SV. RD.			
ML - 1121B			
LA 08J	17	0.000	WY 212 (RM 5.53)
1035		0.790	End Sv. Rd. @Private Rd.

I-80 SV. RD.			
ML - 1123B			
LA 01M	7	0.000	US 30 (RM 371.12) Archer Int.
1035		0.160	E.B. Road Close Gate swing
		6.960	Maint. Break @ Hillsdale Int.
LA 01Q		15.450	Unnamed Draw [BJT;NSR]
1039	7	15.520	County Road to Burns
		16.040	WY 213 (RM 0.10)

I-80 SV. RD.			
ML - 1134B			
LA 01T	9	0.000	Beech St.
1039		0.300	Private Res.

I-80 SV. RD.			
ML - 1137B			
GRAVEL	9	0.000	ML 1123 (RM 4.99)
			south side of I-80
LA 01W		0.020	I-80 Co. Rd. Sep. (RM 375.38)
1035		0.520	Dead End

Maint.

Section	class	RM	US 30 SV. RD.
CREW			ML - 1128B
LA 02N	19	0.000	Polk Av.
1035		0.470	Cleveland St.

US 30 SV. RD.			
ML - 1129B			
LA 02J	19	0.000	US 30 (RM 365.80)
1035		0.530	Polk Av.

US 30 SV. RD.			
ML - 1135B			
LA 02K	19	0.000	Whitney Rd. (east)
1035		0.360	US 30 (RM 367.42)

US 30 SV. RD.			
ML - 1136B			
LA 02M	19	0.000	US 30 (RM 367.61)
1035		0.340	US 30 (RM 367.95)

US 85 SV. RD.			
ML - 1130B			
LA 05J	19	0.000	US 85 (RM 6.31)
1035		1.000	US 85 (RM 5.28)

US 85 SV. RD.			
ML - 1131B			
LA 05K	19	0.000	US 85 (RM 5.02)
1035		0.230	US 85 (RM 5.25)

ROAD COLOR TABLE

	Rural & Urban Interstate #s "1 & 11"
	Urban Principal Arterial Other & Expressway (NHS) #s "12 & 14"
	Urban Minor Arterial, Collector & Local (non NHS) #s "16, 17 & 19"
	Rural Principal Arterial Other (NHS) # "2"
	Rural Minor Arterial, Major & Minor Collectors & Local (non NHS) #s "6, 7, 8 & 9"

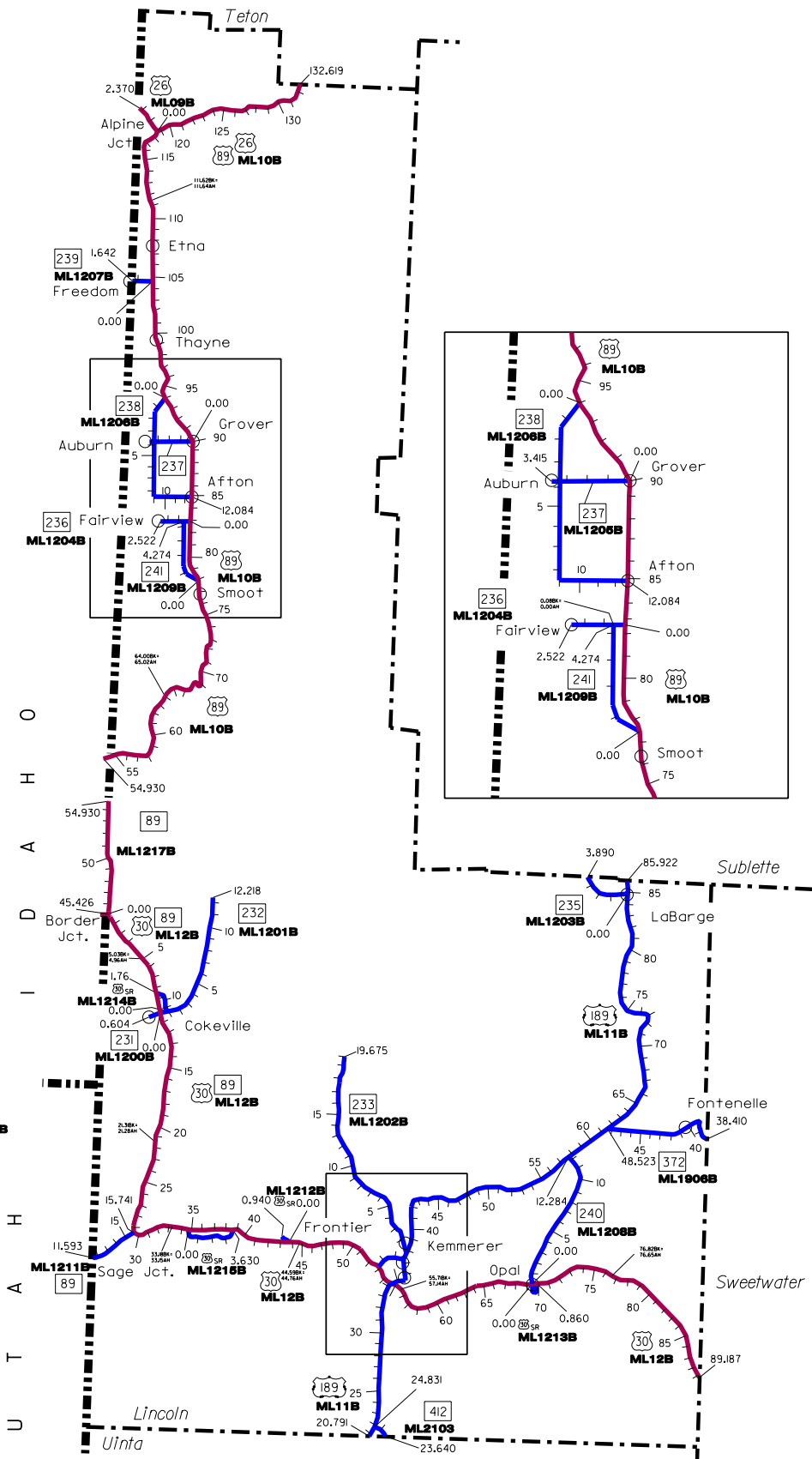
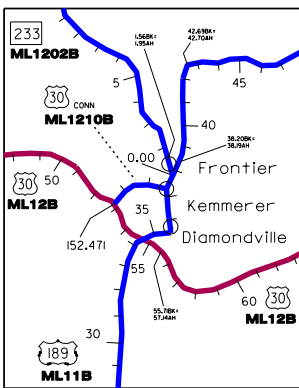
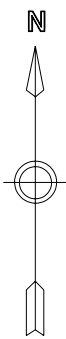

Lincoln

class "classification break"

County 12

Maint. Section	class	RM	WY 89
LN 01A	6	11.593	Utah State Line
3034		15.681	UPRR Sep. (Under) [BNY;SS]
		15.741	US 30 (RM 29.89); Sage Junction

WY 89			
ML - 1217B			
LN 01B	2	45.426	WY 89 (RM 0.24); Border Junction
3034			Begin NHS
		45.560	Border Jct. Wye.
		54.926	Idaho State Line

US 26/89			
ML - 10B			
LN 01C	2	54.926	Idaho State Line
3033			End WY 89 / Begin US 89
		61.475	Bridger Nat'l. Forest Boundary
		63.997	BK= - 1.025 mi.
		65.022	AH Equation
		70.784	County Rd
		71.307	Bridger Nat'l. Forest Boundary
		72.095	Salt River [FDU;SS]
		77.714	Smoot
		77.823	Cottonwood Cr. [DJG;SS]
		78.844	WY 241 (RM 0.00)
		82.095	Dry Cr. [DBM;SS]
		82.976	WY 236 (RM 0.00)
		84.202	SCL Afton
		84.981	WY 238 (RM 12.08)
		85.090	Begin Divided Section
		85.220	End Divided Section
		85.703	Swift Cr. [FCJ;SS]
		86.070	Dept. Shop - Afton AF 03A
		87.470	NCL Afton
		89.966	WY 237 (RM 0.00)
		94.120	WY 238 (RM 0.00)
		95.185	Salt Rv. [BOC;SS], Cont. NHS
		96.201	Salt Rv. [BOD;SS]
		97.490	Star Valley Rest Area LN 01R
		98.166	Etna Irrigation Canal [BOE;SS]
		99.423	Etna Irrigation Canal [KKL;SS]
		99.483	SCL Thayne
		100.352	Etna Irrigation District Canal [BOG;SS]
		100.839	NCL Thayne
		104.390	WY 239 (RM 0.00)
		107.880	Etna
		111.624	BK= - 0.018 mi.
	2	111.642	AH Equation

Maint. Section	class	RM	US 26/89
LN 01C	2	117.867	WCL Alpine
3033		117.757	Greys River Rd
		117.867	NCL Alpine
		118.000	Snake Rv. [BOH;SS]
		118.322	US 26 (RM 0.00)Alpine Spur
			Begin US 26
			Remote loader site AF 981
LN 01D	2	118.935	Targhee Nat'l. Forest Boundary
3039		118.980	E.B. Road Close Gate R/R
		119.000	NB C.M.Sign (dynamic)
	2	132.619	Teton Co. Line / Cont. NHS

US 26			
ML - 09B			
LN 13A	2	0.000	US 26/89 (RM 118.32); Alpine Junction
3033			Begin NHS
		0.550	Alpine Port-of-Entry LN 13P
		2.370	Idaho State Line
			End WY NHS

US 30 & US 189			
ML - 11B			
LN 02A	6	20.791	Uinta Co. Line
3040		21.414	WY 412 (RM 24.83)
		29.840	Shull Point Rd
		29.837	UPRR Sep. (Under) [EWR;SS]
		31.491	UPRR Sep. (Under) [EWS;SS]
		32.730	Elkol Rd
		33.220	SCL Kemmerer
		33.249	UPRR Sep. [EWT;SS]
		33.858	ECL Kemmerer
		34.510	US 30/189 Int. (RM 54.55) [DHA;SS]
			Begin US 30
		35.055	WCL Diamondville
		36.330	CL Kemmerer
LN 02Z	6	37.280	NCL Diamondville
3040		37.280	US 30 (RM 154.52) Connector
			End US 30
		37.349	UPRR Sep. (Under) [EFE;SS]
		37.561	Ham's Fork Rv. [EFH;SS]
		38.071	WY 233 (RM 0.00)
			Dept. Shop - Kemmerer KM 03A
		38.148	NCL Kemmerer
LN 02C	6	42.695	Pomeroy Basin Rd

-cont- next column

-cont- next page

Maint. Section	class	RM	US 30 & US 189
CREW		ML - 11B	
-cont-		(CONTINUED)	
LN 02C	6	42.940	Willow Cr. [LPG;SS]
3040		45.200	N.B. Road Close Gate R/R
		57.460	S.B. Road Close Gate R/R
		57.490	WY 240 (RM 12.28)
		61.390	WY 372 (RM 48.59)
LN 02B		66.487	Reservoir Rd
3041		70.160	Fontennelle Cr. Rd
		77.367	Muddy Cr. [FFP;SS]
		82.297	LaBarge Cr. [FFQ;SS]
		83.960	LaBarge Cr. Rd
		84.640	SCL LaBarge
		84.874	WY 235 (RM 0.00)
		84.890	Dept. Shop - LaBarge LB 03A
		85.467	Birch Cr. [FFV;SS]
	6	85.922	Sublette Co. Line / NCL LaBarge

Maint. Section	class	RM	US 30 & WY 89
		ML - 12B	
LN 03A	2	0.000	Idaho State Line
3034		0.240	WY 89 (RM 45.43); Border Jct.
			Begin WY 89
			Begin NHS
		5.026	BK= + 0.069 mi.
		4.957	AH Equation
		9.950	Smith's Fork Rv. [BQT;SS]
		10.348	NCL Cokeville
		10.387	Spring Cr. [BQU;SS]
		10.582	WY 231 (RM 0.00) & WY 232 (RM 0.00)
		10.841	SCL Cokeville
		13.909	Stock Pass [BQV;SS]
		14.007	Sublette Cr. [BQW;SS]
		18.267	Horse Cr. [BQX;SS]
		21.312	BK= + 0.034 mi.
		21.278	AH Equation
		29.891	US 26 (RM 15.74); Sage Jct. End WY 89
		30.500	Game Crossing [LFN;SS] Remote loader site CV 981
		33.180	BK= + 0.028 mi.
		33.152	AH Equation
		34.010	Sage Jct. RWIS site
		34.918	Stock Trail Sep. [BRA;SS]
		35.240	Game Underpass [LXU;SS]
		35.960	Game Underpass [LXT;SS]
		37.430	Game Underpass [LXS;SS]
LN 03B		38.370	Maint. Break
3040		38.220	Game Underpass [LXR;SS]
		39.695	UPRR Sep. (Under) [BRB;SS]
		38.99	Game Underpass [LXQ;SS]

-cont- next column

Maint. Section	class	RM	US 30 & WY 89
CREW		ML - 12B	
-cont-		(CONTINUED)	
LN 03B	2	40.620	Game Underpass [LXP;SS]
3040		44.589	BK= - 0.174 mi.
		44.763	AH Equation
		45.756	South Fork Twin Cr. [BRC;SS]
		52.161	UPRR Sep. (Under) [FLU;SS]
		52.330	Power Plant Rd.
		52.490	US 30 (RM 152.47) Connector Begin US 30 Bypass WCL Kemmerer
			Kemmerer Port-of-Entry LN 03P
		52.600	W.B. Road Close Gate R/R
		54.400	E.B. Road Close Gate R/R
		54.550	US 30 (RM 34.51) End US 30 Bypass
		55.128	ECL Kemmerer
		55.714	BK= - 1.425 mi.
		57.139	AH Equation
		58.028	Ham's Fork Rv. & UPRR Sep. [BRE;SS]
		69.317	WY 240 (RM 0.00)
		69.360	WCL Opal, Cont. NHS
		69.947	ECL Opal
		71.848	UPRR Sep. (Over)
LN 03C		75.400	Maint. Break
3038		76.819	BK= + 0.17 mi.
		76.649	AH Equation
	2	89.190	Sweetwater Co. Line

Maint. Section	class	RM	US 30 connector
		ML - 1210B	
LN 16A	6	152.471	US 30 (RM 52.49) Mainline
3040		152.400	W.B. Road Close Gate R/R
		154.328	WCL Kemmerer
		154.518	US 189 (RM 37.28)

Maint. Section	class	RM	US 30 connector
		ML - 1216B	
LN 19A	2	0.240	US 30 (RM 0.48), Border Jct. (NHS)
3034		0.470	WY 89 (RM 45.67), (NHS)

Maint. Section	class	RM	WY 231
CREW			ML - 1200B
LN 04A	7	0.000	US 30 (RM 10.58) & WY 232 (RM 0.00)
3034		0.196	Spring Cr. [CRS;SS]
		0.604	End SHS

Maint. Section	class	RM	WY 232
			ML - 1201B
LN 05A	7	0.000	US 30 (RM 10.58) & WY 231 (RM 0.00)
3034		0.090	ECL Cokeville
		0.140	Dept. Shop - Cokeville CV 03A
		2.920	Pine Creek Rd
		12.218	End SHS

Maint. Section	class	RM	WY 233
			ML - 1202B
LN 06A	7	0.000	US 30 (38.07)
3040		0.303	NCL Kemmerer
		0.610	Branch Ham's Fork Rv. [JXN;SS]
		0.710	Frontier
		1.100	Jct. Airport Spur
		1.562	BK= - 0.388 mi.
		1.950	AH Equation
		4.426	Ham's Fork Rv. [CRV;SS]
		19.670	End SHS

Maint. Section	class	RM	WY 235
			ML - 1203B
LN 07A	7	0.000	US 189 (RM 84.87)
3041		0.620	WCL LaBarge
		3.893	Sublette Co. Line

→ -cont- in Sublette County

Maint. Section	class	RM	WY 236
			ML - 1204B
LN 08A	7	0.000	US 26 (RM 82.98)
3033		0.081	BK= + 0.081 mi.
		0.000	AH Equation
			WY 241 (RM 4.27)
		1.547	Salt Rv. [EOQ;SS]
		2.522	Fairview
			End SHS

Maint. Section	class	RM	WY 237
CREW			ML - 1205B
LN 09A	7	0.000	US 26 (RM 89.97) Grover
3033		1.671	Spring Cr.
		2.062	E. Channel Salt Rv. [LMD;SS]
		2.123	W. Channel Salt Rv. [LMC;SS]
		2.494	Unnamed Draw
		3.279	WY 238 (RM 3.88)
		3.430	Auburn
			End SHS

Maint. Section	class	RM	WY 238
			ML - 1206B
LN 10A	7	0.000	US 89 (RM 94.12)
3033		0.070	Canal
		0.278	Salt Rv. [CSB;SS]
		3.878	WY 237 (RM 3.28)
		9.070	Irrigation Canal [CYJ;SS]
		9.354	Crow Cr. [CYT;SS]
		9.884	W. Channel Salt Rv. [FOL;SS]
		10.177	E. Channel Salt Rv. [CYW;SS]
		11.832	WCL Afton
		12.084	US 89 (RM 84.98)

Maint. Section	class	RM	WY 239
			ML - 1207B
LN 11A	7	0.000	US 26 (RM 104.39)
3033		0.943	Salt Rv. [CSD;SS]
		1.642	Idaho State Line

Maint. Section	class	RM	WY 240
			ML - 1208B
LN 12A	7	0.000	US 30 (RM 69.32)
3040		7.450	Exxon Rd
		12.284	US 189 (RM 57.49)

Maint. Section	class	RM	WY 241
			ML - 1209B
LN 15A	7	0.000	US 89 (RM 78.84)
3033		4.274	WY 236 (RM 0.00 AH)

Maint. Section	class	RM	WY 372
			ML - 1906B
LN 12B	7	38.409	Sweetwater Co. Line
3041		40.289	Fontenelle
		48.589	US 189 (RM 61.24)

-cont- from Sweetwater County

Maint.

Section	class	RM	WY 412
CREW		ML - 2103B	

-cont- UI 08A	7	from Uinta County	
3042		23.643	Uinta Co. Line
		24.831	US 189 (RM 21.41)

US 30 SV. RD.			
ML - 1212B			

LN 03N	8	0.000	US 30 (RM 43.80)
		0.330	Twin Cr. [ESZ;NSR]
3040		0.650	Railroad Sep. (Over)
		0.940	End Sv. Rd. Near Historical Site

US 30 SV. RD.			
ML - 1213B			

LN 03L	9	0.000	US 30 (RM 69.30)
		0.210	WCL Opal
3040		0.710	ECL Opal
		0.860	US 30 (RM 69.78)

Maint.

Section	class	RM	US 30 SV. RD.
CREW		ML - 1214B	

	9	0.000	WY 232 (RM 0.29)
GRAVEL		0.240	Spring Cr. [MRU;SS]
LN 05K		0.250	SCL Cokeville
3034		0.540	NCL Cokeville
		0.550	Collette Cr. [MRT;MSS]
		0.680	Smith Fork Rv. [MRV;SS]
		1.760	US 30 (RM 9.86)

US 30 SV. RD.			
ML - 1215B			

LN 03M	9	0.000	US 30 (RM 34.85)
3034		3.630	US 30 (RM 38.47)

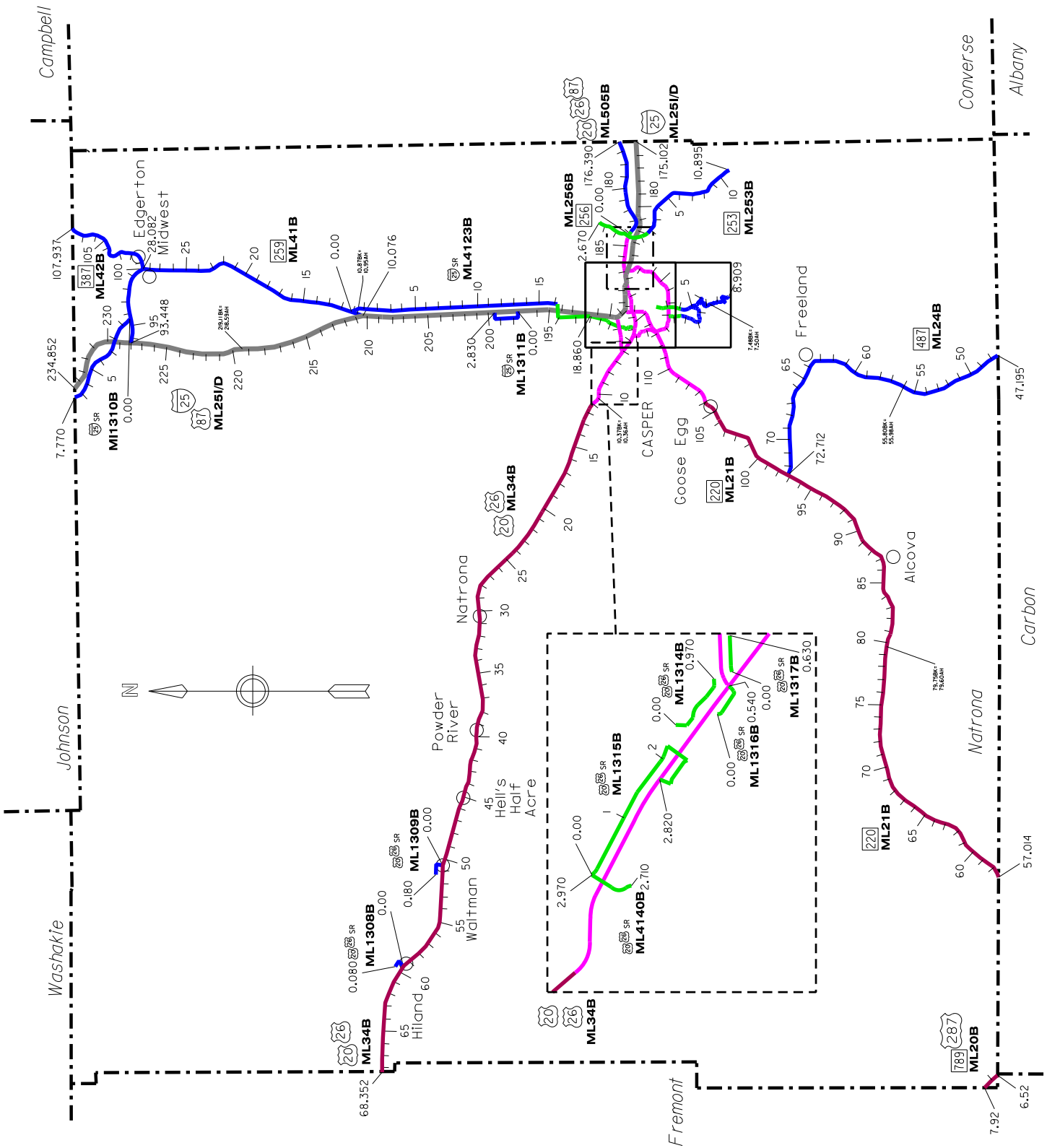

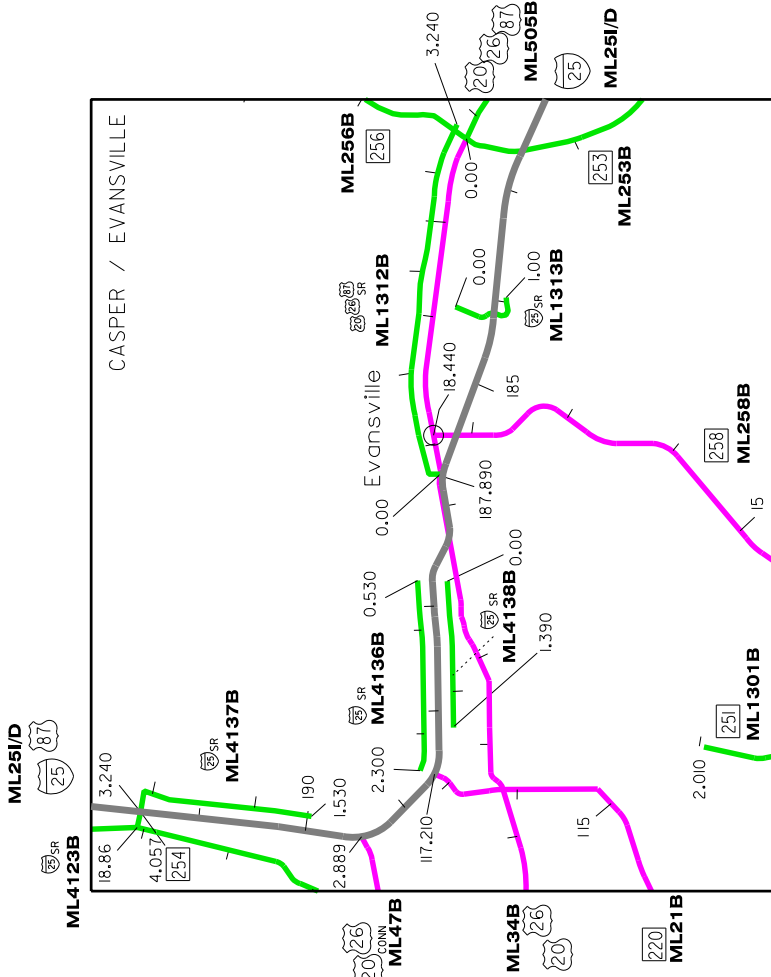

ROAD COLOR TABLE

Grey line	Rural & Urban Interstate #'s "1 & 11"
Magenta line	Urban Principal Arterial Other & Expressway (NHS) #'s "12 & 14"
Green line	Urban Minor Arterial, Collector & Local (non NHS) #'s "16, 17 & 19"
Red line	Rural Principal Arterial Other (NHS) # "2"
Blue line	Rural Minor Arterial, Major & Minor Collectors & Local (non NHS) #'s "6, 7, 8 & 9"

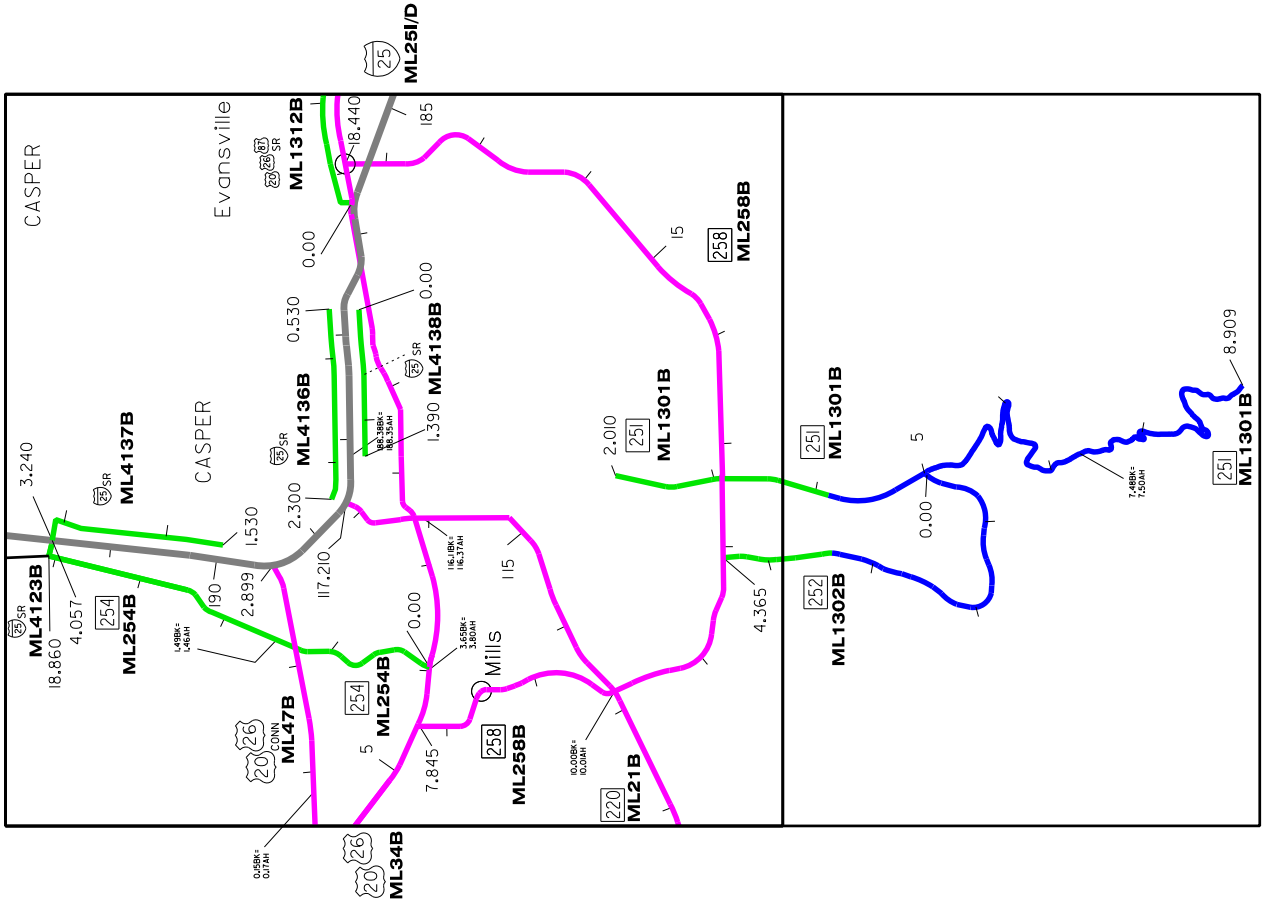

Natrona

class "classification break"

County 1

+ Indicates Non State System

Maint. Section	class	RM	I-25, US 20/26/87
ML - 25			
	1	175.102	Converse Co. Line
NA 01A		175.588	Co. Rd Sep. [AHO;NB, AHP;SB]
2031	1	179.531	Dry Muddy Cr. [AHQ;NB, AHR;SB]
●		182.060	EUL Casper
11		182.530	WY 253 (RM 0.48); Hat Six Int. [CSE;SS] EUL Casper
		182.680	S.B. Road Close Gate R/R
		184.040	Unnamed Draw
		184.148	Co. Rd Sep. [AHT;NB, AHU;SB] SB C.M. Sign (dynamic)
		185.354	WY 258(RM 18.22); Evansville Int. [LXB;NB, LXC;SB]
		185.740	C&NW RR Sep. [AHX;NB, AHY;SB]
		185.750	ECL Casper
		186.290	WCL Casper
		186.452	E. Yellowstone St. Int. [CWZ;SS]
		186.599	BNRR Sep. (Over) [AIA;SS]
		186.760	CL Casper
		186.785	Bryan Stock Trail Int. [AIB;SS] Dept. Shop - Casper DH 02A 0.2 mi. N. on Bryan Stock Trail
→		187.527	McKinley Street Int. [AIF;NB, DKU;SB]
		188.185	WY 255 (RM 0.65); Center Street Int. [AIH;NB, DKV;SB]
NA 01C		188.355	North Platte Rv. [AIJ;NB, DKW;SB]
2042		188.397	BK= + 0.044 mi.
		188.353	AH Equation
		188.600	WY 220 (RM 117.213); Poplar St. Int. [FDG;NB, FDH;SB]
		189.170	WCL Casper
		189.507	US 20/26 (RM 2.90) Shoshoni Int. [EWO;NB, EWP;SB] End US 20 & 26
		191.430	N.B. Road Close Gate R/R
		191.644	WY 254 (RM 4.06); Wardwell Rd Int. [AIS;NB, AIT;SB]
11		194.264	Eight Mile Sep. [AIU;NB, AIV;SB]
●		194.339	NUL Casper
1		197.522	Ormsby Rd Int. [AIW;NB, AIX;SB]
		204.620	Co. Rd Sep. [AIZ;NB, AJA;SB]
		207.160	Twenty Mile Hill RWIS site {16}
		210.120	N.B. Road Close Gate R/R
→		210.412	WY 259(RM 10.08);Horse Ranch Cr.Int. [DOI;NB, DOJ;SB]
NA 01B		214.730	Teapot Rock Sep. [DLV;SS]
2037		216.605	Ranch Rd Int. [LGC;SS]
1		218.747	S. Fork Castle Cr. [DLY;NB, DLZ;SB]

→ -cont- next column

Maint. Section	class	RM	I-25, US 20/26/87
ML - 25			
<i>(CONTINUED)</i>			
	1	219.111	BK= + 0.525 mi.
NA 01B		218.586	AH Equation
2037		221.346	Castle Cr. [DFD;SB, DFE;NB]
		222.231	Machinery Pass Sep. [DFE;SB, DFG;NB]
		223.780	Midwest Int. [DFH;SS]
		226.091	Machinery Pass Sep. [DFI;SB, DFJ;NB]
		227.644	N.B. Road Close Gate R/R
		227.985	WY 387 (RM 93.45); Smokey Gap Int. [DFK;SB, DFL;NB]
		228.284	S.B. Road Close Gate R/R
		230.068	US 87 Sep. [DFM;NB, DFN;SB]
		232.723	Dugout Cr. [DFO;NB, DFP;SB]
1		234.852	Johnson Co. Line
US 20/26 Connector			
ML - 47B			
	12	0.000	US 20/26 (RM 6.05);Mainline Begin NHS & WY 257 (RM 7.30)
NA 12A		0.148	BK= -0.020 mi.
2042		0.168	AH Equation
		0.189	Old Yellowstone Hwy. Sep [CDF;EB, CDG;WB]
		0.353	Railroad X-ing
		0.994	BNRR & Casper Cr.[CDI;WB, CTT;EB]
		2.086	WY 254 (RM 1.40)
		2.899	I-25 (RM 189.51) Shoshoni Int. End NHS
US 20/26/87			
ML - 505B			
	7	176.390	Converse Co. Line
NA 02A	●	183.720	EUL Casper
2031	16	183.896	Begin 4-Lane Section
●		184.064	WY 253 (RM 0.00) & WY 256 (RM 0.00)
14			EB C.M. Sign (dynamic)
		184.158	Claude Cr. [BLV;SS]
		185.277	Elkhorn Cr. [BLW;WB, CON;EB]
→		186.748	ECL Evansville
		186.820	End 4-Lane Section
NA 02Z		186.877	WY 258 (RM 18.43)
2031		186.990	Begin Divided Section
		187.254	WCL Evansville & ECL Casper End Divided Section
14		187.893	I-25 (RM 186.45) Yellowstone St. Int. [CWZ;SS]

Maint. Section	class	RM	US 20/26/87 & I-25 BUS
			ML - 34B
NA 05Z	14	0.000	I-25 (RM186.45) Yellowstone Int. [BMA;SS]
2042		0.050	US 20/26/87 (RM 187.99)
		0.160	BK= + 0.06 mi.
		0.100	AH Equation
		0.111	ECL Casper
		1.634	WY 251 (RM 0.00)
		1.700	WY 255 (RM 0.17)
			End US 87 Bus. & I-25 Bus.
		2.086	North Platte Rv. [DEN;SS]
		2.337	WY 220 (RM 116.476)
		2.854	WCL Casper
		3.649	BK= - 0.153 mi.
NA 05A		3.802	AH Equation
2042		3.860	Casper Cr. [DDF;SS]
		3.931	WY 254 (RM 0.00)
		4.099	C&NW RR Sep. [DDG;SS]
		4.518	WY 258 (RM 7.85); Mills Spur Begin NHS
		4.531	ECL Mills, Cont. NHS
		4.640	WCL Mills
		6.052	US 20/26 Connector (RM 0.00)
			WY 257 (RM 7.302)
		10.365	BK= + 0.008 mi.
	14	10.357	AH Equation
		11.760	WUL Casper
		12.000	EB & WB C.M. Sign (dynamic)
	2	12.889	County Rd (north & south)
		12.900	W.B. Road Close Gate R/R
		16.379	Johnson Lateral [CBI;SS]
		18.390	Bucknum Rd
		19.976	Casper Canal [CBK;SS]
		20.879	S. Fork Casper Cr. [CBL;SS]
		27.944	Middle Fork Casper Cr. [EWK;SS]
		28.998	Middle Fork Casper Cr. [EWL;SS]
		29.811	Middle Fork Casper Cr. [EWM;SS]
		30.000	RWIS site {}
		30.460	Natrona
		39.608	Powder Rv.
		40.146	Wyatt Draw [CBR;SS]
		41.191	S. Fork Powder Rv. [CBT;SS]
		45.158	Hell's Half Acre
		50.689	Waltman Town / District Boundary
		53.210	Waltman Rest Area NA 05R
NA 05B			Web Cam
5037		57.420	Hiland RWIS site {19}
		59.499	Hiland
	2	68.352	Fremont Co. Line / Cont. NHS

Maint. Section	class	RM	US 287 & WY 789
			ML - 20B
FR 02A	2	6.518	Fremont Co. Line (NHS)
2036		7.917	Fremont Co. Line (NHS)
			→ -cont- in Fremont County
			WY 220
			ML - 21B
	2	57.014	Carbon Co. Line / Cont. NHS
		57.623	Rush Cr. [BUC;SS]
NA 04A		62.734	Sweetwater Rv. [BUD;SS]
2036		62.830	Independence Rock Rest Area NA 04R
		65.670	Buzzard Rd
		65.869	Dry Cr. [BUE;SS]
		72.289	Horse Cr. [BUF;SS]
		79.750	BK= + 0.147 mi.
		79.603	AH Equation
		80.100	Pathfinder Hill RWIS site {6}
		80.180	Maint. Break
		85.814	Casper Canal [BUG;SS]
NA 04B		86.480	W.B. Road Close Gate R/R
2031		86.636	Eagle Cr. [BUH;SS]
		94.329	North Platte Rv. [LIK;SS]
		96.590	EB C.M. Sign (dynamic)
		96.813	Bates Cr. [BUJ;SS]
		97.250	W.B. Road Close Gate swing
		97.305	WY 487 (RM 72.71)
		97.810	WB C.M. Sign (dynamic)
		101.110	Unnamed Draw [GUY;SS]
	2	101.356	Cottonwood Cr. [BUK;SS]
		106.074	SUL Casper
		108.050	WY 257 (RM 0.00)
	14	108.110	Begin 4-Lane
		108.200	S.B. Road Close Gate R/R
		110.520	WB C.M. Sign (drum)
		112.249	EB C.M. Sign (dynamic)
		110.896	WCL Casper
		113.360	WY 258 (RM 10.01); Mills Spur Rd End NHS
NA 04Z		113.700	WB C.M. Sign (dynamic)
2031		114.820	Garden Cr. [KWN;SS]
		115.237	End 4-Lane
		116.110	BK= - 0.259 mi.
		116.369	AH Equation
		116.405	North Platte Rv. [BUN;SS]
		116.476	US 20/26, I-25 BUS (RM 2.337)
		116.731	BNRR Sep. (Under) [BUO;SS]
	14	117.213	I-25 (RM 188.60); Poplar St. Int.

Maint. Section	class	RM	WY 251
CREW			ML - 1301B
	+	0.000	US 20/26 BUS (RM 1.63) City Section
	+	0.100	BK= + 0.10 mi.
	+	0.000	AH Equation
NA 08Z	16	2.010	End City / Begin State
2031		3.028	WY 258 (RM 12.65)
→	16	3.577	SCL Casper
●●		4.067	SUL Casper
NA 08A	7	4.467	S.B. Road Close Gate swing
2031		4.943	WY 252 (RM 0.00); Gothmore Park Spur
		5.490	Road Closed "Flashing Beacon"
		7.484	BK= - 0.012 mi.
		7.496	AH Equation
		8.746	Road Closed "Flashing Beacon"
		8.909	End SHS

Maint. Section	class	RM	WY 256
CREW			ML - 256B
	17	0.000	US 20/26 (RM 184.06) & WY 253 (RM 0.00)
NA 15A		0.190	RR at Grade Crossing #089336V
2031		0.570	North Platte Rv. [CSG;SS]
		2.665	End SHS
			WY 257
			Casper West Belt
		***	ML - 257B
		0.000	WY 220 (RM 108.08)
NA 17A		1.895	North Platte River [MBT;SS]
2042		2.644	Oregon Trail Turnout
		3.767	Unnamed Draw (Wetland Area)
		4.256	Overflow Drain
		6.052	Robertson Rd.
		7.302	US 20/26 (RM 6.05)

			WY 252
			Gothmore Park Spur
			ML - 1302B
	7	0.000	WY 251 (RM4.94); Mainline
NA 14A	7	0.400	S.B. Road Close Gate swing
2031	●●	3.361	SUL Casper
→	16	3.990	SCL Casper
NA 14Z			
2031	16	4.365	WY 258 (RM 11.91)

			WY 258
			Casper Outer Belt
			ML - 258B
	14	7.845	NCL Mills
NA 16Z			US 20/26 BUS (RM 4.52)
2031			Begin NHS
→		8.737	SCL Mills & NCL Casper
		9.150	EB C.M. Sign (dynamic)
		8.745	Platte Rv. [CWD;SS]
NA 16Y		10.009	WY 220 (RM 113.26)
2031			End NHS
		11.909	WY 252 (RM 4.37)Spur
		12.610	WY 251 (RM 3.03)
		12.652	CL Casper
		13.520	Mckinley St
		13.770	RWIS site {74}
		16.588	WB C.M. Sign (dynamic)
		15.530	CL Casper
		17.250	Ped. Overpass [FGN;SS]
		17.940	WB C.M. Sign (dynamic)
		18.010	2nd St
		18.080	NCL Casper
		18.220	I-25 (RM 185.35); Evansville Int.
		18.346	SCL Evansville
	14	18.440	US 20,26 (RM 186.88)

			WY 253
			ML - 253B
	17	0.000	US 20/26 (RM 184.064) & WY 256 (RM 0.00)
NA 09A		0.479	I-25 (RM 182.53); Hat Six Int.
2031			[CSE;SS]
●●	17	1.080	SUL Casper
	8	2.799	Dry Muddy Cr. [CSF;SS]
		10.895	End SHS

			WY 254
			ML - 254B
	16	0.000	US 20/26 (RM 3.93)
		0.060	Casper Cr. [DEZ;SS]
NA 10A		0.188	RR at grade crossing #064979U
2042		0.790	NCL Mills
		1.398	US 20/26 (RM 2.09); Salt Cr. Int.[CYF;SS]
		1.491	BK= + 0.03 mi.
		1.461	AH Equation
	16	1.590	Casper Port-of-Entry NA 10P
		1.880	North Yard (Dept.) CA 02A
●●		3.900	Class Break
	17	4.057	I-25 (RM 191.64); Wardwell Rd Int.
			[AIS;NB, AIT;SB]

			WY 259
			ML - 41B
	6	10.076	I-25 (RM 210.41); Horse Ranch Cr. Int.
			[DOI;NB, DOJ;SB]
NA 13A		14.823	East Teapot Cr. [LBC;SS]
2037		15.578	Teapot Cr. [LBD;SS]
		27.846	Salt Cr. [LDB;SS]
		28.082	WY 387 (RM 100.00)

Maint. Section	CREW	class	RM	WY 387
ML - 42B				
NA 06A	2037	6	93.448	I-25 (RM 227.99); Smokey Gap Int. [DFK;SB, DFL;NB]
			97.911	Bothwell Draw [AJH;SS]
			98.360	Salt Cr. [AJG;SS]
			99.370	Dept. Shop - Midwest MW 02A
			100.000	WY 259 (RM 28.21) Conn.; Midwest Jct.
			100.878	WCL Edgerton
			101.437	NCL Edgerton
			101.930	N.B. Road Close Gate R/R
			103.767	Coal Draw [DDA;SS]
			107.937	Johnson Co. Line

Maint. Section	CREW	class	RM	WY 487
ML - 24B				
NA 07A	2041	6	47.200	Carbon Co. Line
			55.790	Sand Cr. [DLP;SS]
			55.795	BK= - 0.186 mi.
			55.981	AH Equation
			61.072	Bates Cr. [DLQ;SS]
			66.130	Little Red Cr. [FGC;SS]
			72.680	E.B. Road Close Gate R/R
			72.712	WY 220 (RM 97.305)

Maint. Section	CREW	class	RM	US 20/26 SV. RD.
ML - 1308B				
NA 05M	5037	9	0.000	US 20/26 (RM 59.50); HILAND
			0.080	US 20/26 (RM 59.58); HILAND

Maint. Section	CREW	class	RM	US 20/26 SV. RD.
ML - 1309B				
NA 05N	5037	9	0.000	US 20/26 (RM 50.69); WALTMAN
			0.180	Arminto Rd

Maint. Section	CREW	class	RM	I-25 SV. RD.
ML - 1310B				
NA 01M	2037	8	0.000	WY 387 (RM 96.28)
			0.023	N.B. Road Close Gate R/R
			1.890	Bridge
			3.120	I-25 Machinery Pass Sep.(RM 230.07) [DFM;NB, DFN;SB]
			5.580	Dougout Cr. [AJI;WSR]
			7.770	Johnson Co. Line

Maint. Section	CREW	class	RM	I-25 SV. RD.
ML - 1311B				
NA 01G	2042	9	0.000	From Dead End N.
			0.750	Ormsby Rd
				Unnamed Draw [AIY;ESR]
			2.830	End Sv. Rd. @Access Opposite I-25 (RM 199.52)

Maint. Section	CREW	class	RM	US 20/26/87 SV. RD.
ML - 1312B				
NA 02K	2031	19	0.000	US 20/26/87 (RM 187.26); In Evansville
			0.010	CL Evansville / Casper
			0.510	ECL Evansville
			1.980	Elkhorn Cr. [BLX;NSR]
			3.210	WY 256
			3.240	End Sv. Rd. @Dead End

Maint. Section	CREW	class	RM	US 20/26 SV. RD.
ML - 1314B				
NA 18A	2042	19	0.000	Old Yellowstone Hwy
			0.970	Old Yellowstone Hwy

Maint. Section	CREW	class	RM	US 20/26 SV. RD.
ML - 1315B				
NA 19A	2042	19	0.000	SV. RD. ML 4140
			1.180	Co. Rd. #119
			2.280	US 20/26 (RM 6.22)
			2.820	US 20/26 (RM 6.67)

Maint. Section	CREW	class	RM	US 20/26 SV. RD.
ML - 1316B				
NA 20A	2042	19	0.000	Zero Rd
			0.540	WY 257 (RM 7.19)

Maint. Section	CREW	class	RM	US 20/26 SV. RD. (CHASE RD)
ML - 1317B				
NA 12B	2042	19	0.000	Old Yellowstone Highway
			0.630	End SR @private resident

Maint. Section	CREW	class	RM	I-25 SV. RD.
ML - 4123B				
NA 01K	2042	9	0.000	WY 259 (RM 10.58)
			0.750	Sheep Cr. [AJC;ESR]
			0.800	Horse Cr. [AJB;ESR]
			16.110	Salt Cr. Hwy.
			16	NUL Casper
			18.860	Wardwell Rd

Maint. Section	CREW	class	RM	I-25 SV. RD. ("F" ST)
ML - 4136B				
NA 01F	2042	17	0.000	US 20/26 (RM 189.81) East Yellowstone
			0.230	RR at grade crossing # 095107P
			0.530	Bryan Stock Trail
			2.030	Bridge North Platte Rv. [AIK;ESR]
			2.300	Rancho Rd. / Poplar Street

Maint.

Section

class

RM

I-25 SV. RD. (RANCHO RD)

ML - 4137B

NA 01J

17

1.530 NCL Casper @JCS Way

2042

3.240 Wardwell Rd

I-25 SV. RD.

ML - 4138B

NA 01E

17

0.000 Jct. Bryan Stock Trail

2042

1.390 Center St. (RM 0.63)

US 20/26 SV. RD.

ML - 4140B

NA 21A

17

2.710 Seven Mile Rd.





2042

2.900 US 20/26 (RM 8.40)

2.970 Sv. Rd. ML 1315

Converse

Weston

ROAD COLOR TABLE	
	Rural & Urban Interstate #'s "1 & 11"
	Urban Principal Arterial Other & Expressway (NHS) #'s "12 & 14"
	Urban Minor Arterial, Collector & Local (non NHS) #'s "16, 17 & 19"
	Rural Principal Arterial Other (NHS) # "2"
	Rural Minor Arterial, Major & Minor Collectors & Local (non NHS) #'s "6, 7, 8 & 9"

N

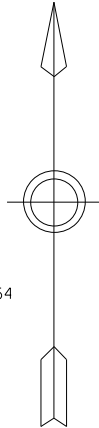

S
O
U
T
H

D
A
K
O
T
A

N
E
B
R
A
S
S
K
A

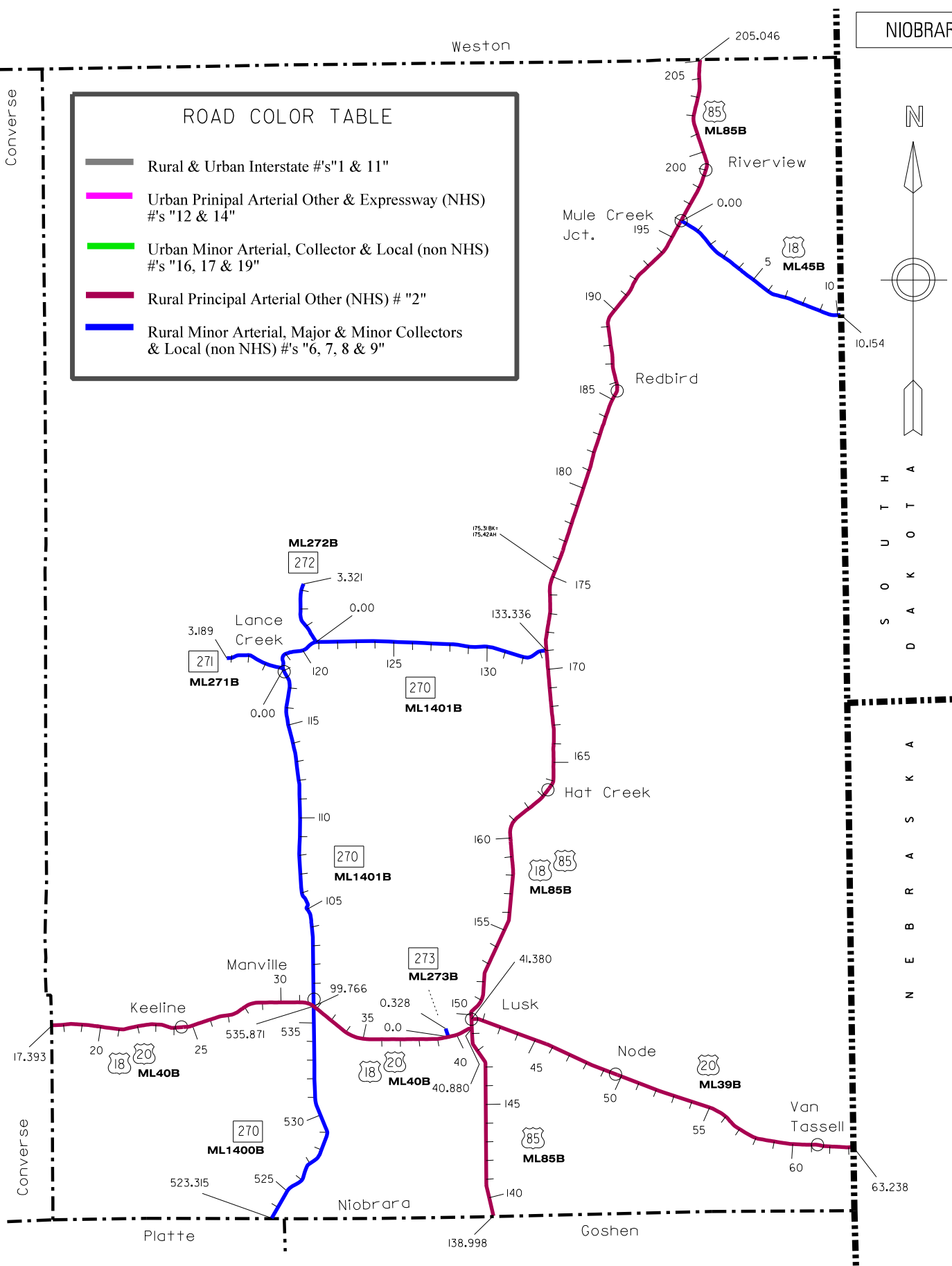

Niobrara

class "classification break"

County 14

Maint. Section	class	RM	US 85/18/20
ML - 85B			
	2	138.998	Goshen Co. Line, Cont. NHS
NI 01A		147.270	County Rd (northeast)
2035		148.570	S.B. Road Close Gate R/R
		148.990	SCL Lusk
NI 01Z		149.272	US 18/20 (RM 40.884) EAST
2035		149.773	Begin US 18 & 20
		150.008	US 18/20 (RM 41.39) WEST
		150.082	End US 20
		150.082	C&NW RR Sep. (Over) [FDD;SS]
		150.082	Niobrara Rv. [FDE;SS]
		150.180	Dept. Shop - Lusk LK 02A
		150.321	NCL Lusk
NI 01B		150.400	N.B. Road Close Gate R/R
2035		170.954	WY 270 (RM 133.34)
		173.738	SB C.M. Sign (dynamic)
		175.313	Old Woman Cr. [BW;SS]
		175.313	BK= - 0.111 mi.
		175.424	AH Equation
		185.100	Red Bird
		185.547	Old Woman Cr. [FEW;SS]
		195.050	Mule Cr. [FGP;SS]
		196.015	S. B. Road Close Gate R/R
		196.042	District Boundary
NI 01C			US 18 (RM 0.00); Mule Cr. Junction
4041			End US 18
			Mule Cr. Rest Area NI 01R
		196.150	N.B. Road Close Gate R/R
		199.797	Cheyenne Rv. [FRA;SS]
		202.001	Bobcat Cr. [FRB;SS]
		202.780	Robbers Roost Cr. [JOH;SS]
	2	205.062	Weston Co. Line
			Cont. NHS
US 18			
ML - 45B			
NI 03A	2	0.000	US 85 (RM 196.042) Mule Cr. Jct.
4041		6.330	Begin NHS
		10.154	Old Highway
			South Dakota State Line
			End WY NHS

Maint. Section	class	RM	US 18/20
ML - 40B			
	2	17.390	Converse Co. Line
NI 02A			Cont. NHS
2035		24.590	Keeline
		30.790	W.B. Road Close Gate R/R
		31.781	WY 270 (RM 535.87)
			& WY 270 (RM 99.77)
		32.800	Stockpass [HTF;SS]
		33.195	Manville Rd
		38.770	W.B. Road Close Gate R/R
		39.230	EB C.M. Sign (dynamic)
		39.290	Lusk Rest Area NI 02R
		39.591	WY 273 (RM 0.00)
		40.605	WCL Lusk
NI 02X		40.790	Lusk Port-of-Entry NI 02P
2035	2	40.884	US 85/18/20 (RM 149.272) South
US 20			
ML - 39B			
	2	41.380	US 85/18/20 (RM 149.27) north
NI 02Z			End US 18 & US 85
2035			Both NHS
		41.718	Niobrara Rv. [LJA;SS]
		41.850	E.B. Road Close Gate R/R
		41.891	ECL Lusk
		49.687	Node
NI 02B		55.690	S. Fork Niobrara Rv. [FDY;SS]
2035		57.848	C&NW RR Sep. (Under) [EOS;SS]
		60.616	WCL Van Tassell
		60.920	Niobrara Rv. [CFC;SS]
		61.170	Railroad X-ing #188616
		61.885	ECL Van Tassell
		62.575	Van Tassell Cr. [FDZ;SS]
	2	63.238	Nebraska State Line
			End WY NHS

Maint.

Maint. Section	class	RM	WY 270
			ML - 1400B
NI 04A	7	523.315	Platte Co. Line
		533.980	Unnamed Draw [JUH;SS]
2035		535.800	S.B. Road Close Gate swing
		535.870	US 18,20 (RM 31.78) & WY 270 (RM 99.77)

Maint.

Maint. Section	class	RM	WY 272
			ML - 272B
NI 08A	8	0.000	WY 270 (RM 120.86)
		2.063	Lance Cr. [BTK;SS]
2035		3.321	End SHS

WY 270

Maint. Section	class	RM	WY 270
			ML - 1401B
NI 05A	7	99.780	US 18,20 (RM 31.781) & WY 270 (RM 535.87)
		100.000	SCL Manville
2035		100.300	N.B. Road Close Gate R/R
		100.380	RR at Grade Crossing #188641D
		100.510	NCL Manville
		116.020	Cherry Creek Bridge [KJT;SS]
		118.090	WY 271 (RM 0.00) Airport Spur
		118.920	Carbon Black Draw
		120.860	WY 272 (RM 0.00)
		122.910	Provost Draw [LOU;SS]
		132.650	Old Woman Cr. [LUI;SS]
		133.300	E.B. Road Close Gate swing
		133.336	US 85/18/20 (RM 170.954)

WY 273

Maint. Section	class	RM	WY 273
			ML - 273B
NI 09A	9	0.000	US 18/20 (RM 39.591)
		0.330	End SHS
2035			Country Club

WY 271

Airport Spur

Maint. Section	class	RM	WY 271
			ML - 271B
NI 06A	8	0.000	WY 270 (RM 118.09)Mainline
		0.171	Lance Cr. [LMG;SS]
2035		0.521	Oil Cr.
		2.527	Sheep Cr.
		2.855	Little Lightning Cr. [LMJ;SS]
		3.189	End SHS

M O N T A N A

PARK

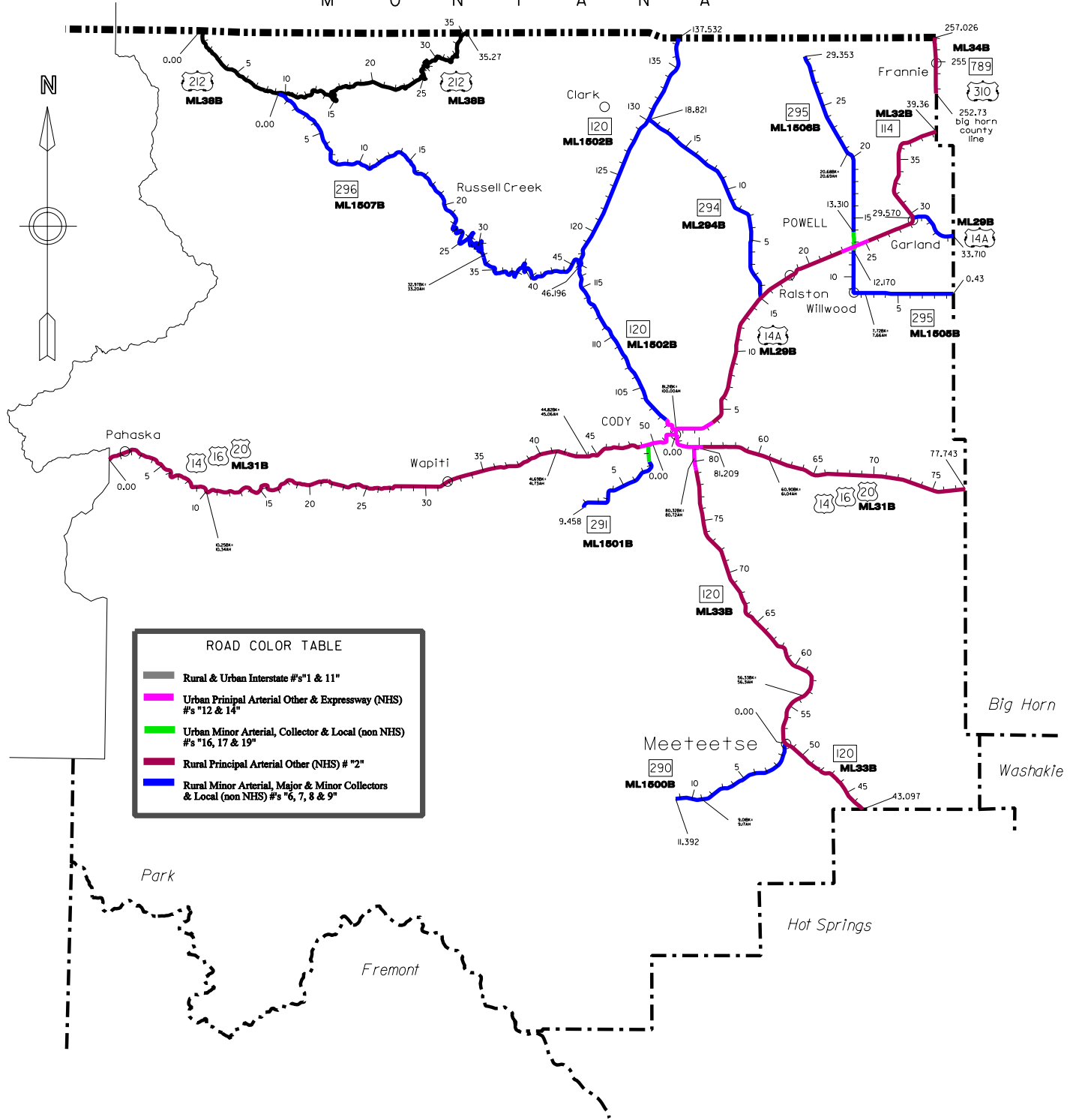

Park

— class "classification break"

County 11

+ Indicates Non State System

Maint. Section	class	RM	US 14/16/20 & WY 120
CREW		ML - 31B	
	2	0.000	W. Boundary Shoshone Nat'l. Forest E. Boundary Yellowstone Park Begin NHS
PA 01A		0.280	Unnamed Draw [JIG;SS]
5032		2.000	Road Closure @Pahaska Lodge <i>Seasonal Closure</i>
		2.040	Pahaska
		2.264	N. Fork Shoshone Rv. [JIM;SS]
		3.701	Grinnel Cr. [JIO;SS]
		4.680	50 Mile Cr. [JIP;SS]
		6.196	Morman Cr. [JIR;SS]
		8.339	Libby Cr. [JIU;SS]
		10.037	Goff Cr. [JIV;SS]
		10.248	BK= - 0.172 mi.
		10.420	AH equation
		12.382	Gunbarrel Cr. [JJA;SS]
		13.556	Cliff Cr.
		14.490	Newton Cr. [JJC;SS]
		15.830	N. Fork Shoshone Rv. [KTB;SS]
		15.990	N. Fork Shoshone Rv. [KTC;SS]
		17.022	Moss Cr. [JF;SS]
		19.740	Clearwater Cr. [JJI;SS]
		20.308	N. Fork Shoshone Rv. [JJJ;SS]
		22.048	Elk's Fork Rv. [JJK;SS]
		24.841	Clocktower Cr. [JBQ;SS]
		27.471	Shoshone Nat'l. Forest Boundary
		31.830	Wapiti
		32.011	N. Fork Shoshone Rv. [DZU;SS]
		36.402	Trout Cr. [DZO;SS]
		40.930	Rattlesnake Canyon Rd
		41.689	BK= - 0.043 mi.
		41.732	AH Equation
		44.820	BK= - 0.242 mi.
		45.062	AH Equation
		45.367	Tunnel [BZQ;SST]
		45.780	Tunnel [BZR;SST]
		45.847	Tunnel [BZS;SST]
	2	46.685	Shoshone Rv. [BZT;SS]
	●	48.748	WUL Cody
	→ 14	48.993	WCL Cody
		49.370	Historical Pullout
PA 01Z		49.510	Demaris Dr.
5032		49.867	WY 291 (RM 0.00)
		50.400	Gulch St
		50.740	Sulphur Cr [FGI;SS]
		51.390	Cody Ave
		51.890	11th St
	14	52.357	US 14A (RM 0.00) BEGIN WY 120

→ -cont- next column

Maint. Section	class	RM	US 14/16/20 & WY 120
CREW		ML - 31B	
		<i>(CONTINUED)</i>	
-cont-		52.870	Newton Ave
PA 01Z	14	52.950	SCL Cody & Stamped Ave.
5032		53.190	END Curb & Gutter Section
	→	53.732	Beck Lake [BZU;SS], Cont. NHS
PA 01B		54.040	26th St
5032		54.576	WY 120 (RM 81.21), Cont. NHS End WY 120
		55.112	Beacon Hill Rd
		55.140	Dept. Shop - Cody CD 05A
	14	55.200	ECL Cody
	●	56.370	EUL Cody
	2	57.163	Sage Cr. [BZW;SS]
		58.630	Sage Cr. Rd
		60.901	BK= - 0.142 mi.
		61.043	AH Equation
		61.670	Oregon Basin Rd
		74.724	Dry Cr. [CAA;SS]
	2	77.743	Big Horn Co. Line/ Cont. NHS
		US 14A & WY 120	
		ML - 29B	
	14	0.000	US 14A (RM 52.36) Begin NHS
PA 02Z		0.250	Salsbury Ave
5032		0.436	WY 120 (RM 100.00) End WYO 120
		0.550	Begin Divided Section
		0.685	End Divided Section
		1.150	Blackburn Ave
	→ 14	2.440	ECL Cody
	●	3.600	EUL Cody
PA 02A	2	3.766	Sage Cr. [CAD;SS]
5032		4.120	County Rd (south)
		6.515	Shoshone Rv. [CAE;SS]
		6.810	Historical Pullout
		10.940	Iron Cr. [LXN;SS]
		12.180	Unnamed Draw [LXO;SS]
		13.513	Garland Canal [LXU;SS]
		14.147	County Rd (east)
		14.720	Eagle Cr.
		15.040	WY 294 (RM 0.00)
		18.114	Ralston
		18.680	RR at Grade Crossing #090690Y
		18.700	Alkali Cr. [LSI;SS]
	2	18.834	Garland Canal [LSJ;SS]
	●	22.630	WUL Powell
	14		Cont. NHS
	→	22.930	WCL Powell, Cont. NHS

Maint. Section	CREW	class	RM	US 14A, WY 120 & WY 114
ML - 29B				
<i>(CONTINUED)</i>				
PA 02Y	14		22.930	WCL Powell, Cont. NHS
5032			23.820	Begin Divided Section
			24.040	WY 295 (RM 12.64) NORTH
PA 02X			24.080	WY 295 (RM 12.57) SOUTH
5035			24.730	ECL Powell
	14		24.830	End Divided Section
PA 02B			25.330	EUL Powell
5035			29.004	Bitter Cr. [CAH;SS]
			29.520	WY 114 (RM 29.57)
	6		30.140	BNRR Sep. (Under) [FCK;SS]
			33.710	Big Horn Co. Line

US 212
ML - 38B
(+ Park Service Highway)

+	0.000	Montana State Line (West)
+	1.037	Index Cr.
+	1.951	Fox Cr.
+	4.462	Clark's Fork Rv.
+	6.378	Crazy Cr.
+	7.990	Gilbert Cr.
+	8.755	BK= - 0.354 mi.
+	9.109	AH Equation
+	9.395	WY 296 (RM 0.00)
+	10.589	Lake Cr.
+	18.330	Beartooth Cr.
+	20.230	Little Beartooth Cr.
+	21.030	Little Beartooth Cr.
+	23.280	Long Lake
+	35.270	Montana State Line (East)

US 310 & WY 789
ML - 34B

-cont-				from Big Horn County
	2		252.727	Big Horn Co. Line Cont. NHS
BH 03D			254.645	SCL Frannie
5035			254.712	Frannie Port-of-Entry BH 03P Web Cam
			255.393	NCL Frannie
			257.012	Sage Cr. [CDE;SS]
			257.026	Montana State Line
				End WY NHS

Maint. Section	CREW	class	RM	WY 120
ML - 33B				
		2	43.100	Hot Springs Co. Line / Cont. NHS
			49.720	S.B. Road Close Gate R/R
PA 03A			50.200	Dept. Shop - Meeteetse MT 05A
5036			51.050	Old dept. shop site
			51.380	SCL Meeteetse
			51.633	WY 290 (RM 0.00)
			51.718	NCL Meeteetse
			51.733	Greybull Rv. [LBB;SS]
			52.426	Spring Cr. [CAU;SS]
			54.258	Meeteetse Cr. [CAV;SS]
			54.320	Rd West
			56.325	BK= + 0.015 mi.
			56.310	AH Equation
			58.000	Burlington Rd
			58.250	N.B. Road Close Gate R/R
			58.402	Cottonwood Cr. [CAW;SS]
			61.530	Meeteetse Rim RWIS site {18}
			62.357	Little Dry Cr. [CAX;SS]
			66.020	Dry Cr. [HJS;SS]
			66.600	County Rd (east)
			69.000	Oregon Basin Rd
			72.909	Sage Cr. [CAY;SS]
		2	74.000	Maint. Break
PA 03B			79.160	SUL Cody
5032		14	79.903	Cody Canal [DIW;SS]
			80.315	BK= - 0.409 mi.
			80.724	AH Equation
			81.073	Alkali Lake [BQY;SS]
			81.160	S.B. Road Close Gate R/R
		14	81.209	BK= - 18.79 mi.
				US 14/16/20 (RM 81.21)

WY 120
ML - 1502B

PA 08Z	14		100.000	AH Equation
5032				US 14A (RM 0.44)
			100.384	NCL Cody
	14		100.530	Shoshone Rv. [FUV;SS]
PA 08A			101.460	NUL Cody
5032		6	102.681	Heart Mountain Canal [FLK;SS]
			105.003	Cottonwood Cr. [FLL;SS]
			106.234	Cottonwood Cr. [FLM;SS]
			107.713	Cottonwood Cr. [FLN;SS]
			108.205	Unnamed Draw
			116.910	WY 296 (RM 46.20)
			128.885	Clark's Fork Rv. [CTH;SS]
			129.501	Clark's Fork Rv. [CTI;SS]
			130.100	WY 294 (RM 18.82)
			135.140	Big Sand Coulee [LBY;SS]
	6		137.532	Montana State Line

Maint. Section	CREW	class	RM	WY 114
				ML - 32B
		2	29.544	US 14A (RM 29.52)
			30.140	BNRR Overpasss [FCK;SS]
			34.229	Deaver Canal [CAI;SS]
PA 05A			36.649	County Rd (north)
5035			36.620	RR at Grade Crossing #091482B
			36.650	Deaver Canal [CAI;SS]
			39.355	Big Horn Co. Line
				Cont. NHS

→ -cont- in Big horn Co.

				WY 290
				ML - 1500B
		7	0.000	WY 120 (RM 51.63)
			0.456	SCL Meeteetse
PA 06A			6.040	Wood Rv. [LIN;SS]
5036			9.009	BK= - 0.164 mi.
			9.173	AH Equation
			11.392	End SHS

				WY 291
				ML - 1501B
PA 07Z		16	0.000	US 14/16/20 (RM 49.867)
5032				
			0.360	SCL Cody
		16	0.400	Trailer Park
PA 07A			1.660	SUL Cody
5032		7	3.142	Cody Canal W. Sulphur [JLW;SS]
			4.640	County Rd (south)
			4.854	Cody Canal [JLX;SS]
			5.491	Diamond Cr.
			7.060	Cody Canal [JLZ;SS]
			9.460	End SHS

				WY 294
				Badger Basin Rd
				ML - 294B
		7	0.000	US 14A (RM 15.04)
			0.020	RR at Grade Crossing #090695H
PA 09A			0.299	Garland Canal [CTM;SS]
5032			3.976	Alkali Cr. [CTN;SS]
			10.620	Big Sandy Coulee [FIZ;SS]
			13.470	Unnamed Draw [FJA;SS]
			18.820	WY 120 (RM 130.10)

Maint. Section	CREW	class	RM	WY 295
				ML - 1505B
				from Big Horn County
		7	0.432	Big Horn Co. Line
PA 10A			2.983	Roan Wash [CTO;SS]
5035			7.715	BK= + 0.051 mi.
			7.664	AH Equation
			8.226	Willwood Draw [FKB;SS]
			8.682	Willwood
		7	9.551	Shoshone Rv. [CTQ;SS]
			11.860	SUL Powell
		16	12.170	SCL Powell
				End State / Begin City
		+	12.510	RR at Grade Crossing #090681A
				RR at Grade Crossing #090682G
		+	12.549	Garland Canal [CTR;SS]
		+	12.570	US 14A (RM 24.08)

				WY 295
				ML - 1506B
		+	12.638	US 14A (RM 24.00)
PA 10Z		16	13.310	Begin State / End City
5035				7th St
		16	13.820	NCL Powell
PA 10B			14.050	NUL Powell
5035		7	18.196	Frannie Canal [EOV;SS]
			29.353	End SHS
				Elk Basin

				WY 296
				Chief Joseph
				ML - 1507B
		7	0.000	US 212 (RM 9.40)
			1.108	Lake Cr. [CTZ;SS]
PA 16A			3.411	Muddy Cr. [CTY;SS]
5032			6.211	Clark's Fork Rv. [CTX;SS]
			7.600	Crandall Cr. [CAN;SS]
			20.400	Dept. Shop - Russell Creek RC 05A
			22.982	Sunlight Cr. [EUO;SS]
			23.480	Sunlight Basin Rd
			25.080	Dead Indian Cr. [FOK;SS]
			32.960	Chief Joseph RWIS site {59}
			32.971	BK= - 0.229 mi.
			33.200	AH Equation
			38.200	Shoshoni NF Boundry
			46.120	Pat O'Hara Cr. [AGE;SS]
			46.200	WY 120 (RM 116.91)

ROAD COLOR TABLE	
	Rural & Urban Interstate #'s "1" & "11"
	Urban Principal Arterial Other & Expressway (NHS) #'s "12 & 14"
	Urban Minor Arterial, Collector & Local (non NHS) #'s "16, 17 & 19"
	Rural Principal Arterial Other (NHS) # "2"
	Rural Minor Arterial, Major & Minor Collectors & Local (non NHS) #'s "6, 7, 8 & 9"

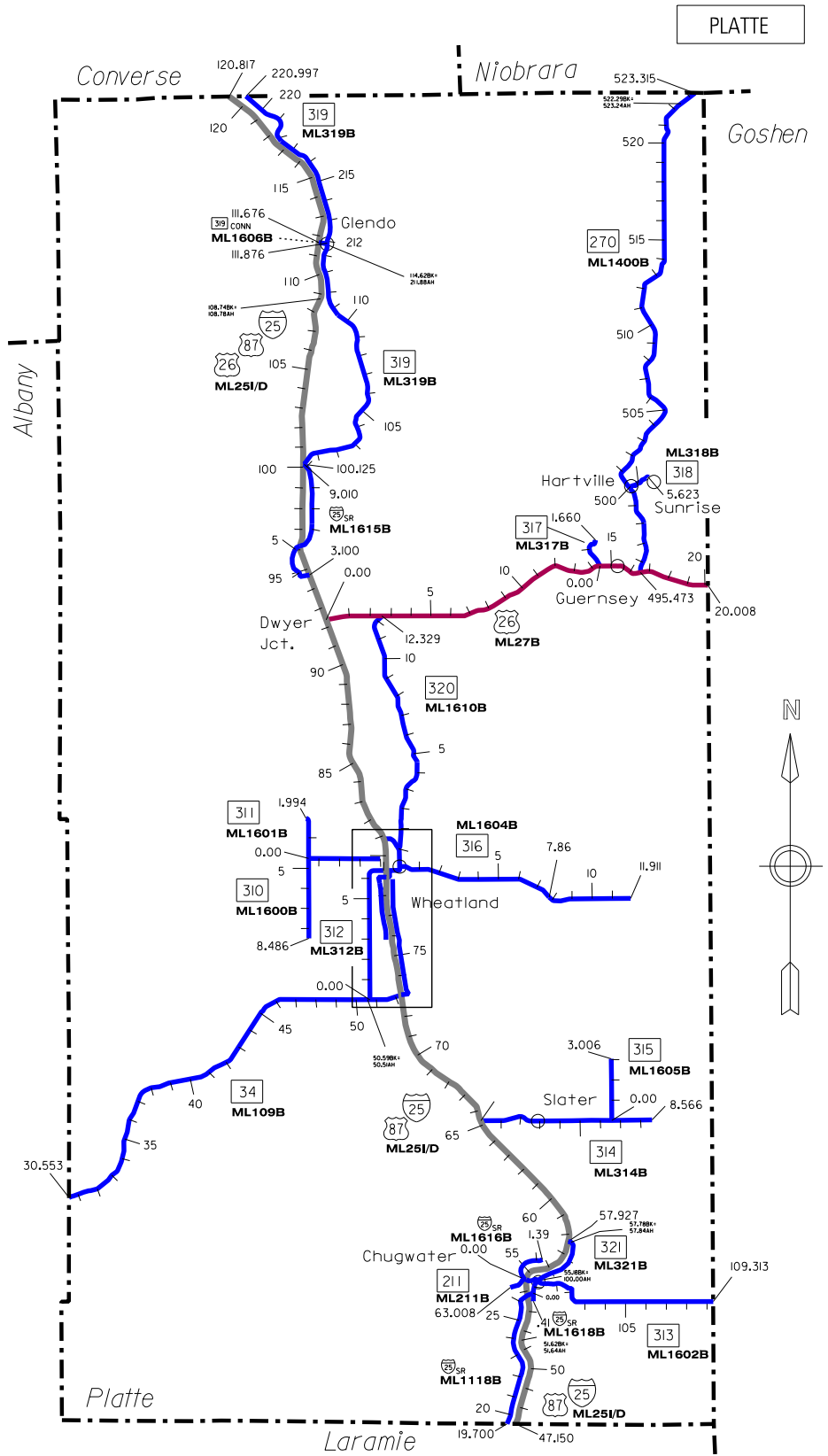
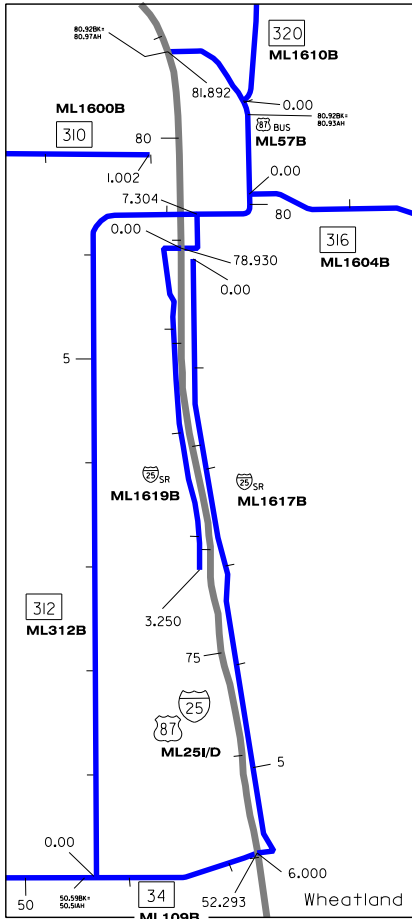

Platte

County 8

— class "classification break"

+ Indicates Non State System

Maint. Section	class	RM	I-25 & US 87
		ML - 25	
	1	47.151	Laramie Co. Line
		47.250	Co. Line Int. Underpass [DCW;SS]
PL 01A		50.655	Co. Rd Overpass [DCX;NB, DCY;SB]
2033		51.619	BK= - 0.016 mi.
		51.635	AH Equation
			NB C.M. Sign (dynamic)
		53.488	SCL Chugwater
		53.877	Old US 87 Sep. [ACT;NB, ACU;SB]
		54.031	Chugwater Cr. [ACV;NB, ACW;SB]
		54.140	BNRR Sep. (Under) [ACY;NB, ACZ;SB]
		54.340	S.B Road Close Gate R/R
		54.500	CL Chugwater
		54.590	WY 313 (RM 54.59); Chugwater Int. [ADB;NB, ADC;SB]
			& WY 211 (RM 63.95)
			Chugwater Rest Area PL 25R
		54.830	N.B. Road Close Gate R/R
		55.013	CL Chugwater
		56.460	NCL Chugwater
		57.649	WY 321 (RM 57.93); Ty Basin Int. [ADD;NB, ADE;SB]
		59.013	Unnamed Draw [ADF;NB, ADG;SB]
		59.400	SB C.M. Sign (dynamic)
		64.037	Richeau Cr. [ADH;NB, ADI;SB]
		65.253	WY 314 (RM 0.00); Slater Rd Int. [CUG;SS]
		66.200	Hunton Int. [ADJ;SS]
		68.454	Antelope Int. [ADK;NB, ADL;SB]
		69.700	NB C.M. Sign (dynamic)
		70.621	Bordeaux Int. [ADM;NB, AND;SB]
		70.800	Bordeaux RWIS site {13}
		71.500	SB C.M. Sign (dynamic)
		72.360	Maint. Break
		73.025	WY 34 (RM 52.29); WY 34 Int. [ADO;NB, ADP;SB]
PL 01B		76.617	Rock Cr. [CBU;SS]
2039		77.000	SB C.M. Sign (dynamic)
		77.820	S.B. Road Close Gate R/R
		78.347	SCL Wheatland
		78.931	US 87 BUS (RM 78.93);S.Wheatland Int. [CKR;SS]
		79.278	South Street Overpass [BRH;NB, CBF;SB]
		79.447	#2 Canal [BPF;NB, BTF;SB]
		79.594	Pedestrian Underpass
		79.846	Oak Street Underpass [CGT;SS]
		80.096	NCL Wheatland
		80.853	US 87 BUS (RM 81.89);N. Wheatland Int. [BTH;NB, BTI;SB]

Maint. Section	class	RM	I-25 & US 87
		ML - 25	
		<i>(CONTINUED)</i>	
	1	80.920	BK= - 0.053 mi.
		80.973	AH Equation
		81.503	BNRR Sep. (Under) [ADT;NB, ADU;SB]
		82.020	N.B. Road Close Gate R/R
		82.198	Fairview Sep. [ADV;SS]
PL 01B		84.003	Laramie Rv. [ADW;NB,ADX;SB]
2039		84.744	Laramie Rv. Int. [ADY;NB, ADZ;SB]
		87.032	Laramie Rv. [AEA;NB, AEB;SB]
		87.505	N. Laramie Rv. Int. [AEC;NB, AED;SB]
		88.625	Fish Cr. [AEE;NB, AEF;SB]
		92.371	US 26 (RM 0.00); Dwyer Jct. Int. [AEG;NB, AEH;SBR], Begin US 26
			Dwyer Jct. Rest Area PL 01R
		92.860	N.B. Road Close Gate R/R
		94.825	El Rancho Int. [AEJ;NB, AEK;SB]
		95.140	Spring Cr. [AEL;NB, AEM;SB]
		95.696	Spring Cr. [AEO;NB, AEP;SB]
		96.423	Co. Rd Sep. [AEQ;NB, AER;SB]
		96.721	Cottonwood Cr. [AET;NB, AEU;SB]
		98.506	Co. Rd Sep. [AEV;NB, AEW;SB]
		98.710	Coleman RWIS site {14}
		100.125	WY 319 (RM 100.13); Cassa Int. [AEX;NB, AEY;SB]
		100.560	South Bear Cr. [AEZ;NB, AFA;SB]
		103.993	Middle Bear Cr. [AFB;NB, AFC;SB]
		104.043	Middle Bear Int. [AFD;NB, AFE;SB]
		108.736	BK= - 0.045 mi.
		108.781	AH Equation
		109.118	Machinery Pass Sep. [AFF;NB, AFG;SB]
		109.486	Horseshoe Cr. [AFH;NB, AFI;SB]
		110.552	Horseshoe Cr. Sep. [AFJ;NB, AFK;SB]
		111.396	SCL Glendo
		111.675	WY 319 (RM 111.68); Glendo Int. [AFL;NB, AFM;SB]
PL 01C		112.176	NCL Glendo
2034		114.675	Co. Rd Overpass [CHD;NB, CZH;SB]
		117.465	Elkhorn Co. Rd Sep [CZI;NB, CZJ;SB]
		117.683	Elkhorn Cr. [CZK;NB, CZL;SB]
		119.866	Machinery Pass Sep. [CZM;NB, CZN;SB]
	1	120.817	Converse Co. Line

→ -cont- next column

Maint. Section	class	RM	US 26
			ML - 27B
	2	0.000	I-25 (RM 92.37); Dwyer Jct. [AEG;NB, AEH;SBR], Begin NHS
PL 04A		1.300	County Rd (north)
2039		2.600	WY 320 (RM 12.33)
		3.280	Dwyer Rd.
		4.096	BNRR Sep. (Under) [BPG;SS]
		12.180	Wendover Rd.
		14.400	W.B. Road Close Gate R/R
		14.417	WY 317 (RM 0.00)
		14.740	North Platte Rv. [EOE;SS]
		14.780	WCL Guernsey
		15.501	ECL Guernsey
		16.222	BNRR Sep. (Under) [BXM;SS]
		16.500	Yard (Dept.) GU 02A
		16.549	WY 270 (RM 495.47)
		17.800	Guernsey Rest Area PL 04R
		18.706	Whalen Draw [BXN;SS]
		20.008	Co. Line Draw [BXO;SS]/Goshen Co Line Cont. NHS

Maint. Section	class	RM	WY 34
			ML - 109B
	6	30.553	Albany Co. Line / District Boundary
		32.380	W.B. Road Close Gate R/R
PL 03A		32.567	South Sybille Cr. [DZQ;SS]
2039		34.012	Sybille Cr. [EVZ;SS]
		35.883	Blue Grass Cr. [EVL;SS]
		36.850	Wheatland Tunnel Rd.
		41.629	Sybille Cr. [EVK;SS]
		44.450	County Rd. (south)
		44.844	Canal #3 [EVJ;SS]
		44.981	Sand Cr. [EVI;SS]
		45.179	Canal #3 [DJV;SS]
		46.450	County Rd. (north & south)
		46.532	Lateral #1 [EVH;SS]
		50.590	BK= +0.081 mi
		50.509	AH Equation
		50.640	W.B. Road Close Gate R/R
		50.655	WY 312 (RM 0.00)
		52.293	I-25 (RM 73.03); WY 34 Int. [ADO;NB, ADP;SB]

Maint. Section	class	RM	US 87 Bus.
			ML - 57B
	6	78.931	I-25 (RM 78.93); S. Wheatland Int. [CKR;SS]
PL 19A		79.070	Dept. Shop - Wheatland WL 02A
2039		79.404	WY 310 (RM 0.00) & WY 312 (RM 7.30)
		80.017	Wheatland Canal #2 [KBR;SS]
		80.096	WY 316 (RM 0.00)
		80.474	Oak St.
		80.670	CL Wheatland
		80.920	BK= - 0.014 mi.
		80.934	AH Equation
		80.964	CL Wheatland
		81.027	WY 320 (RM 0.00)
		81.714	NCL Wheatland
		81.891	I-25 (RM 80.85); N. Wheatland Int. [BTH;NB, BTI;SB]

Maint. Section	class	RM	WY 211
			ML - 211B
	7	63.008	Begin SHS
PL 13A		63.034	WCL Chugwater
2033		63.160	NCL Chugwater
		63.954	I-25 (RM 54.59); Chugwater Int. [ADB;NB, ADC;SB]

Maint. Section	class	RM	WY 270
			ML - 1400B
	7	495.470	US 26 (RM 16.549)
PL 05A		499.830	SCL Hartville
2039		500.000	WY 318 (RM 4.53)
		500.020	N.B. Road Close Gate swing
		500.210	WCL Hartville
		517.810	Miller Draw [FGF;SS]
		522.289	BK= -0.947 mi.
		523.236	AH Equation
		523.315	Niobrara Co. Line

Maint. Section

CREW	class	RM	WY 310
			ML - 1600B
	+	0.000	US 87 bus. (RM 79.40) & WY 312 (RM 7.30)
		0.500	Oak Street
	+	0.628	Oak Street Underpass [CGT;SS]
PL 06A	7	1.002	WCL Wheatland
2039			End City Section / Begin State
		1.438	WY DVLPMT #2 Canal [CBA;SS]
		4.160	WY DVLPMT Canal [CBB;SS]
		4.499	WY 311 (RM 0.00)
		4.510	WY DVLPMT Canal [CBX;SS]
		8.490	End SHS @Co. Rd. to Reservoir

**WY 311
North Spur**

CREW	class	RM	WY 311
			ML - 1601B
PL 14A	7	0.000	WY 310 (RM 4.50)
2039		1.990	End SHS @Co. Rd.

WY 312

CREW	class	RM	WY 312
			ML - 312B
	8	0.000	WY 34 (RM 50.655)
		2.927	Rock Cr. [CCD;SS]
PL 07A		5.990	County Rd. (west)
2039		6.226	WCL Wheatland
		7.176	South Street Overpass
		7.304	US 87 Bus. (RM 79.40)

WY 313

CREW	class	RM	WY 313
			ML - 1602B
	7	100.000	WY 321 (RM 55.18)
		100.050	RR at Grade Crossing #245470L
PL 08A		100.270	E.B. Road Close Gate swing
2033		100.483	Chugwater Cr. [CUF;SS]
		100.739	ECL Chugwater
		109.253	Goshen Co. Line

WY 314

CREW	class	RM	WY 314
			ML - 314B
	8	0.000	I-25 (RM 65.25); Slater Rd Int. [CUG;SS]
PL 09A		1.969	Richeau Cr. [CUH;SS]
2033		2.840	RR at Grade Crossing #245478R
		3.000	Slater
		3.284	Chugwater Cr. [CUI;SS]
		6.563	WY 315 (RM 0.00) North Spur
		8.566	End SHS

Maint. Section

CREW	class	RM	WY 315
			North Spur
			ML - 1605B
PL 15A	8	0.000	WY 314 (RM 6.56)
2033		2.840	RR at Grade Crossing #245478R
		3.000	Slater
		3.010	End SHS

WY 316

CREW	class	RM	WY 316
			ML - 1604B
	+	0.000	US 87 Bus. (RM 80.10)
	+	0.070	8th St.
	7	0.091	End City Section / Begin State
PL 10Z		0.120	RR at Grade Crossing #245492L
2039		0.210	Rock Cr. [KET;SS]
		0.530	Front St.
		0.810	Airport Rd.
		0.820	ECL Wheatland
PL 10A	7	3.202	Chugwater Cr. [LHG;SS]
2039		7.858	Class. Break
	8	11.911	End SHS

WY 317

CREW	class	RM	WY 317
			ML - 317B
PL 11A	8	0.000	US 26 (RM 14.417)
2039		1.660	Guernsey Reservoir
			End SHS

WY 318

CREW	class	RM	WY 318
			ML - 318B
PL 05B	7	4.529	WY 270 (RM 500.00)
2039		5.180	ECL Hartville
		5.630	End SHS

WY 319

CREW	class	RM	WY 319
			ML - 319B
	8	100.125	I-25 (RM 100.13); Cassa Int.
PL 16A			[AEX;NB, AEY;SB]
2039		104.822	South Bear Cr.
		105.830	Cassa
		106.347	Middle Bear Cr. [CUM;SS]
		108.035	North Bear Cr. [CUN;SS]
		112.454	Horseshoe Cr. [FJB;SS]
		114.189	Whiskey Cr. [CZF;SS]
		114.282	SCL Glendo
		114.309	BNRR Sep. [MIO;SS]
		114.622	BK= - 97.26 mi.
			Maint. Brk. @ Equation
		211.876	AH Equation WY 319 (RM 111.88)
			Glendo Connector
PL 18A		212.413	NCL Glendo
2034		214.289	Dry Wash [CZG;SS]
		217.893	Elkhorn Cr. [CYY;SS]
	8	220.997	Converse Co. Line

Maint. Section	class	RM	WY 319 Glendo Connector
PL 20A	8	111.680	I-25 (RM 111.68); Glendo Int.
2034		111.830	RR at Grade Crossing #089268W
		111.880	WY 319 (RM 211.88)

Maint. Section	class	RM	WY 320
PL 17A	7	0.000	US 87 Bus. (RM 81.03)
2039		0.057	CL Wheatland
		0.480	County Rd. (west)
		1.217	Wheatland Cr. [CNI;SS]
		2.180	Power Plant Rd.
		2.370	N.B. Road Close Gate swing
		2.518	Wheatland Cr. [CUE;SS]
		3.913	Laramie Rv. [FEJ;SS]
		4.500	UVA Rd.
		5.036	North Laramie Rv. [FFM;SS]
		12.329	US 26 (RM 2.60)

Maint. Section	class	RM	WY 321
PL 02A	9	54.590	I-25 (RM 54.59); Chugwater Int.
2033			[ADB;NB, ADC;SB]
			& WY 211 (RM 63.95)
		54.840	WCL Chugwater
		55.180	WY 313 (RM 100.00)
		55.660	Dept. Shop - Chugwater CW 02A
		55.700	N.B. Road Close Gate swing
		56.640	NCL Chugwater
		57.781	BK= - 0.057 mi.
		57.838	AH Equation
		57.927	I-25 (RM 57.65); Ty Basin Int.
		57.927	End SHS @Cattleguard

Maint. Section	class	RM	I-25 SV. RD.
PL 01K	9	19.700	Laramie Co. Line
2033		26.000	CL Chugwater
		26.430	I-25 Overpass
		26.580	Chugwater Cr. [ACX;ESR]
		26.900	Railroad Sep. (Under) [ADA;ESR]
		27.060	S.B. Road Close Gate swing
		27.220	WY 313 (RM 55.01)

Maint. Section	class	RM	I-25 SV. RD.
PL 01N	9	3.100	I-25 (RM 94.83); El Rancho Int.
2039		3.560	Spring Cr. [AEN;WSR]
		5.030	I-25 Sep. (RM 96.44)
		5.360	Cottonwood Cr. [AES;ESR]
		9.010	WY 319 (RM 100.20)

Maint. Section	class	RM	I-25 SV. RD.
PL 01J	9	0.000	WY 211 (RM 63.81)
2033		0.510	CL Chugwater
		1.390	End Sv. Rd. @Trail

Maint. Section	class	RM	I-25 SV. RD.
PL 01M	9	0.000	16th & Cole Streets
2039		0.130	15th st.
		0.200	14th st.
		0.550	South CL Wheatland
		2.020	Gibson Rd.
		3.040	Snook Rd.
		3.740	Yard (Dept.) WL 02B
		6.110	I-25 (RM 73.03) WY 34 Int.

Maint. Section	class	RM	I-25 SV. RD.
PL 01H	9	0.000	South Chugwater Rd.
2033		0.410	CL of Chugwater

Maint. Section	class	RM	I-25 SV. RD.
PL 22A	8	0.000	I-25 (RM 78.93)
2039		0.700	CL Wheatland
		0.090	Class. Break
	9	2.450	Rock Cr. [ADQ;WSR]
		3.250	End Sv. Rd. @Dead End

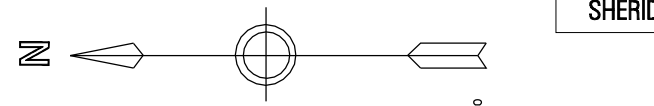

	Rural & Urban Interstate #'s "1 & 11"
	Urban Principal Arterial Other & Expressway (NHS) #'s "12 & 14"
	Urban Minor Arterial, Collector & Local (non NHS) #'s "16, 17 & 19"
	Rural Principal Arterial Other (NHS) # "2"
	Rural Minor Arterial, Major & Minor Collectors & Local (non NHS) #'s "6, 7, 8 & 9"

M O N T A N A

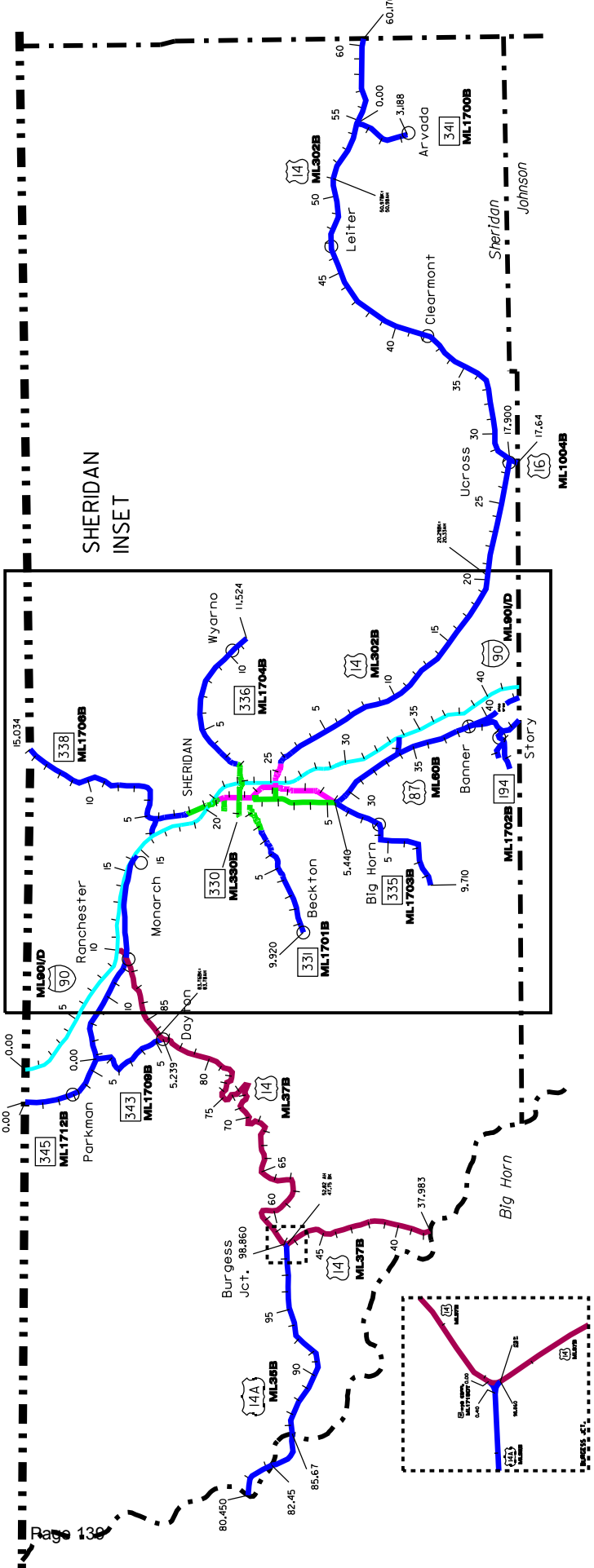

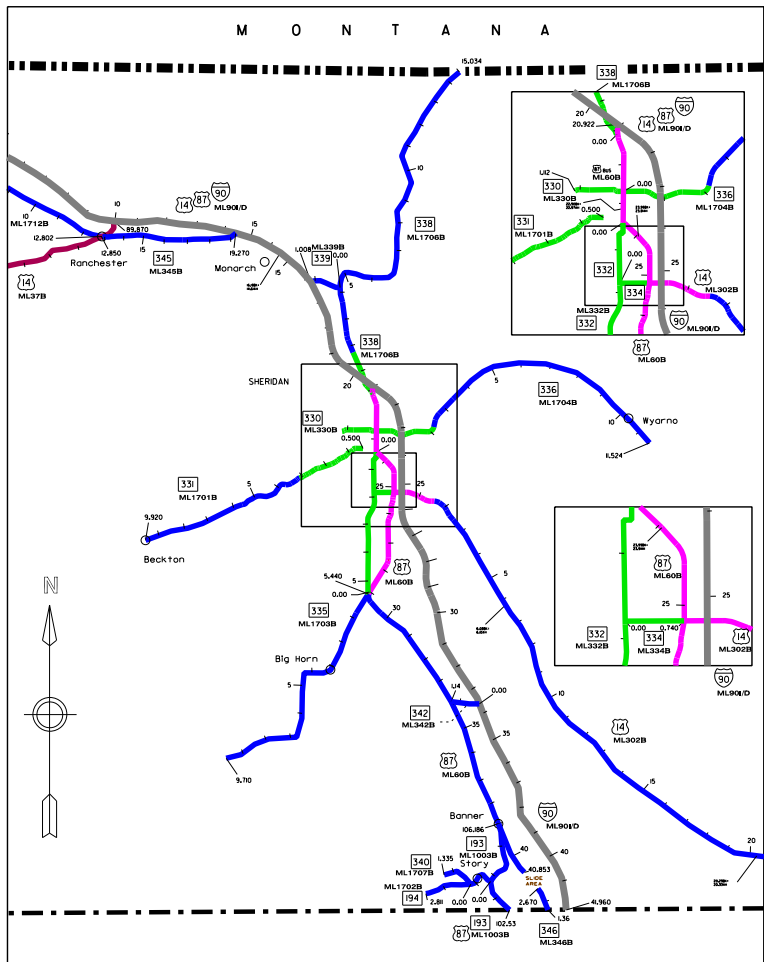

SHERIDAN INSET

Sheridan

County 3

— class "classification break"

+ Indicates Non State System

Maint. Section	class	RM	I-90, US 87 & US 14
ML - 90			
	1	0.000	Montana State Line
		0.100	State Line RWIS site {52}
		1.794	Parkman Int. [EEO;EB, EOP;WB]
SH 01A		4.190	Machinery Pass Sep. [EUI;EB, EUJ;WB]
4033		6.300	Machinery Pass Sep. [EUK;EB, EUL;WB]
		8.414	Machinery Pass Sep. [EVD;EB, EVE;WB]
		9.300	W.B. Road Closed Gate R/R
		9.882	US 14 (RM 89.87); Ranchester Int. [DZX;EB, DZY;WB], Begin US 14
		11.014	County Rd Overpass [DZZ;EB, EAA;WB]
		11.861	Machinery Pass Sep. [EAB;EB, EAC;WB]
		13.288	Co. Rd Sep. [EAG;EB, EAH;WB]
		14.155	Machinery Pass Sep. [EAE;EB, EAF;WB]
		16.185	BK= + 1.576 mi.
		14.609	AH Equation
		14.618	WY 345 (RM 19.27); Acme Int. [BAV;EB, BAW;WB]
		14.890	BNRR Sep. (Under) [BAX;EB, BAY;WB]
		15.010	Tongue Rv. [BAZ;EB, BBA;WB]
		16.341	WY 339 (RM 1.01); Dietz Int. [LLW;SS]
			Sheridan Port-of-Entry SH 01P
		16.600	W.B. Road Closed Gate R/R
		17.700	Co. Rd Sep. [BBB;EB, BBC;WB]
	1	18.178	EB C.M.Sign (dynamic)
	—		WB C.M.Sign (dynamic)
	11	18.390	Co. Rd Sep. [BBD;EB, BBE;WB]
		18.930	NUL Sheridan
		19.460	Co. Rd Sep. [BBF;EB, BBG;WB]
		20.531	Old Highway Sep. [BBH;EB, BBI;WB]
		20.592	Big Goose Cr. [BBJ;EB, BBK;WB]
		20.920	I-90 BUS (RM 20.92); N. Sheridan Int. [BBL;EB, BBM;WB]
		21.100	BNRR & Co. Rd Sep. [BBN;EB, BBO;WB]
		21.970	Co. Rd Sep. [BBP;EB, BBQ;WB]
		23.156	WY 336 (RM 0.95); 5th St. Int. [KKY;EB, KKZ;WB]
			Sheridan Info. Center & Rest Area SH 01R
		23.540	Co. Rd Sep. [BBT;EB, BBU;WB]
	11	23.730	BNRR Sep. (Under) [BBV;EB, BBW;WB]
	—	24.510	Machinery Pass Sep. [BBX;EB, BBY;WB]
		25.200	E.B. Road Closed Gate R/R
		25.300	US 14 BUS (0.29); US 14 Int. [BBZ;EB, BCA;WB]
			End US 14 & 87

Maint. Section	class	RM	I-90, US 87 & US 14
ML - 90			
<i>(CONTINUED)</i>			
	11	25.300	US 14 BUS (0.29); US 14 Int. [BBZ;EB, BCA;WB], End US 14 & 87
		26.770	EB C.M.Sign (dynamic)
			WB C.M.Sign (dynamic)
SH 01B	—	29.230	SUL Sheridan
4033	1	32.981	Meade Cr. [BCB;EB, BCC;WB]
		33.598	WY 342 (RM 0.00); Meade Rd Int. [BCD;EB, BCE;WB]
		36.097	Pompey Cr. Rd Sep. [BCF;EB, BCG;WB]
		36.339	Machinery Pass Sep. [BCH;EB, BCI;WB]
		37.155	Prairie Dog Co. Rd Int [BCJ;EB, BCK;WB]
		37.561	Machinery Pass Sep [BCL;EB, BCM;WB]
	1	41.958	Johnson Co. Line
			-cont- Johnson Co.
US 14A			
ML - 35B			
-cont-			from Big Horn county
	6	80.450	Big Horn Co. Line/District Boundry
		82.450	Sheridan Co. Line
		82.400	W.B. Road Close Gate R/R
SH 06A		85.670	Big Horn Co. Line
4038		93.680	N. Fork Tongue River [HPP;SS]
		98.100	W.B. Road Close Gate R/R
			<i>Seasonal Closure</i>
		98.640	Dept. Shop - Burgess Jct. BJ 04A
		98.690	Wye Connector (RM 0.410)
		98.860	US 14 (RM 47.75); Burgess Jct. End US 14A / Begin NHS US 14
US 14 Y Conn.			
OT - 1718			
SH 24A	6	0.000	Begin East Wye US 14 (RM 57.06)
4038		0.370	End East Wye US 14A (RM 98.69)

Maint. Section	class	RM	US 14/14A
CREW		ML - 37B	
SH 04A 4038	2	37.983	Big Horn Co. Line / District Boundary Cont. NHS
		38.210	Hunt Mtn. Rd.
		42.510	Wolf Rd.
		46.100	W.B. Road Closed Gate R/R
		47.750	US 14A/14 (RM 98.86); Burgess Jct. BK= - 9.07 mi.
		56.820	AH
		57.060	Overhead Sign Wye Connector (RM 0.00)
		58.406	Medicine Wheel Visitor Center SH 04R
		60.164	South Fork Tongue Rv. [JBZ;SS]
		69.868	BK= - 2.742 mi.
		72.610	AH Equation
		76.590	Big Horn Nat'l. Forest
		77.320	Maint. Break
		81.400	W.B. Road Closed Gate R/R
SH 04B 4033	2	82.801	WCL Dayton
		82.847	Little Tongue Rv. [CDP;SS]
		83.535	Tongue Rv. [CDQ;SS]
		83.553	NCL Dayton
		83.643	WY 343 (RM 5.24)
		83.760	BK= - 0.02 mi.
		83.780	AH Equation
		88.454	WCL Ranchester
		88.600	Unnamed Draw [HQC;SS]
		89.380	BNRR Sep. (Under) [CDR;SS]
		89.548	WY 345 (RM 12.80) Begin US 87
		89.548	WY 345 (RM 12.85); ECL Ranchester
		89.870	I-90 (RM 9.882); Ranchester Int. End NHS

Maint. Section	class	RM	US 14/87 BUS & US 14/16
CREW		ML - 302B	
SH 03A 4033	14	0.000	US 87 (RM 25.16); East Spur & WY 334 (RM 0.74)
		0.279	I-90 (RM 25.30); US 14 Int. End US 14 bus & US 87 Bus. Begin US 14
		1.480	Wakely Rd.
		1.610	EUL Sheridan
		2.090	Deadman Cr. [IZV;SS]
		4.910	Prairie Dog Cr. [DLG;SS]
		5.280	Upper Cat Rd. (east)
		6.081	BK= - 0.023 mi.
		6.104	AH Equation
		7.280	Meade Cr Rd (east)
		10.480	Upper Prairie Dog Rd.
		14.910	Dow Prong Rd (north)
		19.370	Lower Piney Rd (south)
		20.275	BK= - 0.053 mi.
SH 03B 4036	7	20.328	AH Equation
		21.420	Piney Cr. [DLH;SS]
		25.417	Boxelder Cr. [DLI;SS]
		27.765	US 16 (RM 17.90); Ucross Jct. Begin US 16
		27.835	Piney Cr. [FLE;SS]
		27.960	Ucross
		28.316	Coal Cr. [FLD;SS]
		29.421	Donkey Cr. [IYX;SS]
		33.081	Unnamed Draw
		35.890	Ulm Rd
		36.087	Lonetree Cr. [FDP;SS]
		37.750	Town Draw [FJO;SS]
		37.800	SCL Clearmont
		38.650	NCL Clearmont
39.464	Whitmeyer Draw [CKO;SS]		
41.410	Blackstump Draw [CKP;SS]		
43.839	Deadman Cr. [LCN;SS]		
45.983	Clear Cr. [BTG;SS]		
46.950	Leiter		
50.988	BK= - 0.014 mi.		
50.974	AH Equation		
52.668	BNRR Sep. (Under) [FHX;SS]		
54.720	US 14/16 (RM 0.00); Arvada Spur		
55.063	Powder Rv. [FHY;SS]		
60.170	Campbell Co. Line		

Maint. Section	class	RM	US 14/87 BUS, I-90 BUS & US 87
		ML - 60B	
	14	20.922	I-90 (RM 20.92); N. Sheridan Int.
		21.140	WY 338 (RM 0.00)
SH 02Z			End Divided Section
4033		21.650	RR at Grade Crossing #098901V
		21.662	WY 337 (RM 0.00)
			Begin 4-Lane
		21.702	NCL Sheridan
		22.220	Begin Divided Section
SH 02A		22.605	WY 330 (RM 0.00)
4033			& WY 336 (RM 0.00)
		22.792	Motel Ped. Overpass
		22.894	Little Goose Cr. [BMS;SS]
		22.899	BK= - 0.069 mi.
		22.968	AH Equation
			End Divided Section
		23.337	WY 331 (RM 0.00)
		23.461	WY 332 (RM 0.00)
		23.990	BK= + 0.079 mi.
		23.911	AH Equation
		24.200	SCL Sheridan
		24.314	Little Goose Cr. [DEM;SS]
		25.159	US 14 BUS (RM 0.00)
			& WY 334 (RM 0.74)
			End US 14 Bus., US 87 Bus. & I-90 Bus.
			Begin US 87
		25.870	Sheridan Jr College
		27.698	Little Goose Cr. [CZY;SS]
	14	29.110	WY 335 (RM 0.00)
	●	29.150	SUL Sheridan
	7	29.677	Little Goose Cr. [CZZ;SS]
		32.770	Kruse Creek Rd.
	7	33.926	WY 342 (RM 1.14)
		35.617	Bird Farm Rd.
	●	38.900	US 87/WY 193 (RM 106.19)
	9	40.850	Roadway Ends @Slide Area
		US 16	
		ML - 1004B	
-cont-		from Johnson county	
JO 13A	7	17.640	Johnson Co. Line
4036		17.900	US 14 (RM 27.765)

Maint. Section	class	RM	WY 193
		ML - 1003B	
-cont-		from Johnson county	
	7	102.527	Johnson Co. Line
SH 07A		103.582	S. Piney Cr. [FFA;SS]
4033		103.919	WY 194 (RM 0.00)
		103.982	N. Piney Cr. [FFB;SS]
		104.340	Scenic Overlook
		106.142	US 87 (RM 38.90)
		WY 194	
		<i>Fish Hatchery road</i>	
		ML - 1702B	
	7	0.000	WY 193 (RM 103.92); Mainline
SH 17A		0.350	Prairie Dog Cr. [CQO;SS]
4033		0.593	WY 340 (RM 0.00)
		1.079	Prairie Dog Cr. [BMW;SS]
		2.811	End SHS
		WY 330	
		ML - 330B	
	16	0.000	US 14 (RM 22.61)
			& WY 336 (RM 0.00)
SH 08Z		0.080	Val Vista St.
4033		0.190	Big Goose Cr. [CUO;SS]
		1.040	Kentucky St.
		1.110	WCL Sheridan
			End SHS / Begin Non-State
	+	3.070	WUL Sheridan
		WY 331	
		ML - 1701B	
	+	0.000	US 14 (RM 23.34)
	+	0.500	Big Goose Cr. [DKQ;SS]
	16	0.723	End City / Begin State
SH 09A			Highland Ave.
4033	16	0.860	WCL Sheridan
	●	3.100	WUL Sheridan
	7	4.060	Big Goose Cr. [CUQ;SS]
		6.480	Big Goose Cr. [CUR;SS]
	7	9.916	Beckton, End SHS

Maint. Section	class	RM	WY 332
CREW			ML - 332B
	+	0.000	US 14,87,I-90 bus. (RM 23.46)
	16	0.560	SCL Sheridan
SH 10A			End City / Begin State
4033		1.350	Airport Spur Road
		1.620	WY 334 (RM 0.00);East Spur
		5.440	WY 335 (RM 0.00)

Maint. Section	class	RM	WY 334
			ML - 334B
	16	0.000	WY 332 (RM 1.62); Mainline
SH 19A			Dept. Shop - Sheridan DH 04A
4033		0.360	Little Goose Cr. [JNN;SS]
		0.740	US 14 (RM 25.16)
			US 14 Bus. (RM 0.00)

Maint. Section	class	RM	WY 335
			ML - 1703B
	17	0.000	US 87 (RM 29.11)
SH 11A	●	0.050	SUL Sheridan
4033	7	0.160	WY 332 (RM 5.440)
		3.135	Big Horn
		7.040	Little Goose Canyon Rd (south)
		7.200	Colorado Colony Ditch [DAH;SS]
		9.710	End SHS

Maint. Section	class	RM	WY 336
			ML - 1704B
SH 12Z	16	0.000	US 14 (RM 22.61)
4033			& WY 330 (RM 0.00)
		0.140	RR at Grade Crossing #104171R
	16	0.630	ECL Sheridan
SH 12A	●	0.951	I-90 (RM 23.156); 5th Street Int.
4033	17	1.180	<i>Sheridan Info. Center & Rest Area</i> <i>SH 01R (I-90 MP 23.15)</i>
	17	1.250	Maint. Break
		1.450	New Dept. Shop - Sheridan DH 04B
	●	2.180	EUL Sheridan
	7	3.412	Prairie Dog Cr. [CUT;SS]
		4.450	Lower Prairie Dog Rd (north)
		5.570	Wildcat Cr. [CUU;SS]
		7.040	RR at Grade Crossing #098799S
		7.250	RR at Grade Crossing #098798K
		8.437	Dutch Cr. [CUV;SS]
		9.580	Negro Draw [ILJ;SS]
		10.350	WYARNO
	7	11.524	End SHS

Maint. Section	class	RM	WY 338
			ML - 1706B
	17	0.000	US 14 (RM 21.14)
SH 14A		0.160	Big Goose Cr. [FEC;SS]
4033	17	0.596	Old Highway Sep.
	●	1.710	NUL Sheridan
	7	3.285	Big Goose Cr. & BNRR Sep. [FEF;SS]
		4.145	WY 339 (RM 0.00); Jensik Connector
		10.500	Ash Cr Oil Field Rd.
		10.730	Tongue Rv. [FLO;SS]
		11.130	Ash Cr [FSC;SS]
		13.220	Young's Cr. [FQM;SS]
	7	15.030	Montana State Line

Maint. Section	class	RM	WY 339
			ML - 1705B
	7	0.000	WY 338 (RM 4.15); Mainline
SH 20A		0.020	BNRR at Grade Crossing #104137J
4033		0.060	Big Goose Cr. [CVC;SS]
		1.008	I-90 (RM 16.341); Dietz Int.[LLW;SS]

Maint. Section	class	RM	WY 340
			ML - 1707B
SH 15A	7	0.000	WY 194 (RM 0.59)
4033		1.355	End SHS

Maint. Section	class	RM	WY 341
			<i>Arvada Spur</i> ML - 1700B
SH 16A	7	0.000	US 14/16 (RM 54.82)
4036		1.850	RR at Grade Crossing #098763J
		3.188	Arvada / End SHS

Maint. Section	class	RM	WY 342
			ML - 342B
SH 21A	8	0.000	I-90 (RM 33.598); Meade Rd. Int.
4033		1.136	US 87 (RM 33.93)

Maint. Section	class	RM	WY 343
			ML - 1709B
SH 22A	7	0.000	WY 345 (RM 5.80)
4033		0.020	RR at Grade Crossing #104141Y
		5.239	US 14A/14 (RM 83.643)

Maint.

Section	class	RM	WY 345
CREW			ML - 1712B
	7	0.000	Montana State Line
SH 80A		5.795	WY 343 (RM 0.00)
4033		9.621	Unnamed Draw [BAQ;SS]
		11.386	Five Mile Cr. [BAR;SS]
		12.264	NCL Ranchester
		12.400	N.B. Road Closed Gate R/R
		12.802	US 14/14A (RM 89.548)

			WY 345
			ML - 345B
	9	12.849	US 14/14A (RM 89.55)
SH 80B		12.890	ECL Ranchester
4033		14.295	Six Mile Cr. [BAS;SS]
		15.530	Early Cr. [BAT;SS]
		18.096	Slater Cr. [BAU;SS]
		19.267	I-90 (RM 14.618); Acme Int. End SHS

			WY 346
			ML - 346B
-cont-			from Johnson county
SH 02C	9	1.360	Johnson County line
4033		2.670	Roadway Ends @Slide Area

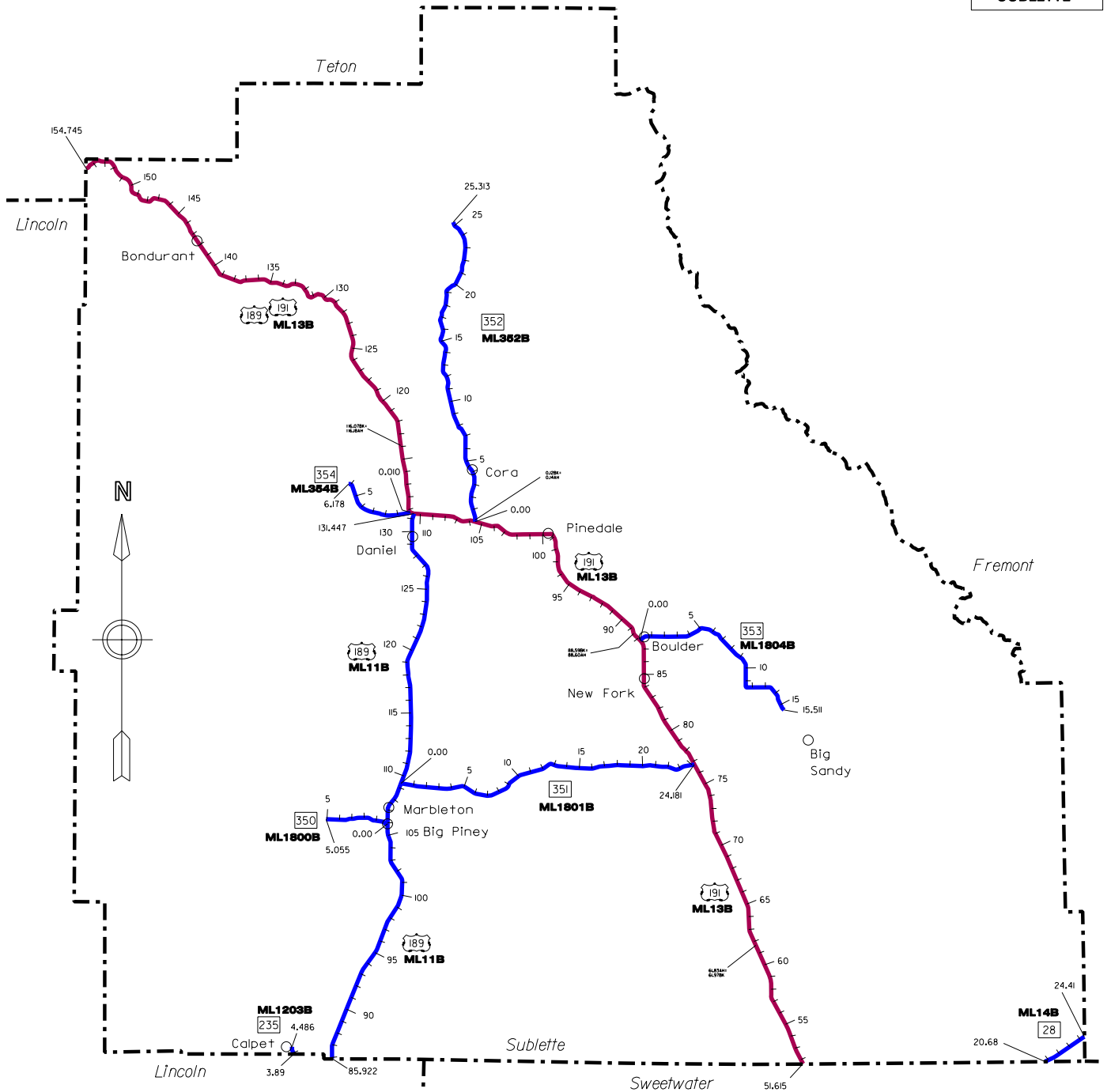

ROAD COLOR TABLE	
	Rural & Urban Interstate #'s "1 & 11"
	Urban Prinipal Arterial Other & Expressway (NHS) #'s "12 & 14"
	Urban Minor Arterial, Collector & Local (non NHS) #'s "16, 17 & 19"
	Rural Principal Arterial Other (NHS) # "2"
	Rural Minor Arterial, Major & Minor Collectors & Local (non NHS) #'s "6, 7, 8 & 9"

Sublette

class "classification break"

County 23

Maint. Section	class	RM	US 189
ML - 11B			
	6	85.922	Lincoln Co. Line
			NCL Labarge
SB 01A		90.080	Unnamed Draw [FJF;SS]
3041		90.770	Unnamed Draw [FJH;SS]
		93.395	Dry Wash [BQD;SS]
		96.520	Oil Field Rd
		97.494	Dry Piney Cr.
		104.620	South Piney Rd
		104.842	South Piney Cr. [BQF;SS]
		105.420	County Rd
		105.810	SCL Big Piney
		105.943	WY 350 (RM 0.00)
		106.096	North Piney Cr. [BQG;SS]
SB 01B		106.315	NCL Big Piney
3035		106.929	SCL Marbleton
		107.470	NCL Marbleton
		107.960	Meadow Cr.
		107.970	Airport Rd
		109.384	WY 351 (RM 0.00)
		116.332	Muddy Cr. [JAZ;SS]
		120.394	S. Cottonwood Cr. [KEY;SS]
		120.569	N. Cottonwood Cr. [KEZ;SS]
		123.327	Green River Supply Canal [BQL;SS]
		123.699	Green River Supply Canal [BQM;SS]
		127.380	Cottonwood Rd
		128.180	Desmet Rd
		128.887	Horse Cr. [BQN;SS]
		129.560	Daniel
		129.713	Prairie Rv. [DMA;SS]
		130.374	S. Fork Green Rv. [DMB;SS]
		130.515	N. Fork Green Rv. [DMC;SS]
		130.902	Faler Cr. [DMD;SS]
	6	131.448	US 191/189 (RM 110.47) Daniel Jct.

US 191/189 Y Conn

OT - 1805

SB 01N	6	0.000	US 189 (RM 131.31)
3035		0.306	US 191/189 (RM 110.24)

US 191 & 189

ML - 13B

SB 02A	2	51.615	Sweetwater Co. Line
3037		75.500	Remote loader site FS 982
		76.750	WY 351 (RM 24.18)
		84.260	East Fork Rv. [BNQ;SS]
SB 02B		84.450	Fish Hatchery Rd
3035	2	87.789	WY 353 (RM 0.00); Boulder

-cont- next column

Maint. Section	class	RM	US 191/189
ML - 13B			
<i>(CONTINUED)</i>			
	2	88.229	Boulder Cr. [BRN;SS]
SB 02B		88.589	BK= - 0.010 mi.
3035		88.600	AH Equation
		92.648	Pole Cr. [DGW;SS]
		92.778	Wenz Airport Rd
		95.478	S. Bench Rd
		98.478	Fayette-Pole Cr Rd
		98.968	SCL Pinedale
SB 02Z		99.388	Fremont Lake Rd
3035		99.878	Pine Cr. [BRP;SS]
		100.268	WCL Pinedale
		100.590	Dept. Shop - Pinedale PN 03A
		100.780	Barber Cr [JBF;SS]
		101.028	Ehman Ln
SB 02D		101.178	New Fork Rv. [JBE;SS]
3035		102.578	Duck Cr. [JBD;SS]
		104.403	Wildlife Crossing [MJE;SS]
		105.518	WY 352 (RM 0.00)
		105.838	Duck Cr.
		105.888	Stock Pass [JOI;SS]
		106.303	Wildlife Crossing [MJD;SS]
		106.803	Wildlife Crossing [MJC;SS]
		110.466	US 189 (RM 131.45); Daniel Jct.
			Begin US 189
		110.748	WY 354 (RM 0.01)
		111.903	Wildlife Crossing [MJB;SS]
		112.275	Animal Over Pass
		112.603	Wildlife Crossing [MJA;SS]
		113.103	Wildlife Crossing [MIZ;SS]
		113.928	Fish Hatchery Rd
		110.790	N.B. Road Close Gate R/R
		116.065	BK= - 0.11 mi.
		116.175	AH Equation
		120.176	Green Rv. [DAC;SS]
		123.627	Hay Gulch [BRU;SS]
		127.010	Rim RWIS site {2}
		127.448	North Beaver Cr. [BRV;SS]
		129.446	Teton-Bridger Nat'l. Forest Boundary
		138.640	Muddy Cr. [BRW;SS]
		138.978	Hoback Rv. [DJB;SS]
		142.746	Bondurant
		145.148	Lower Hoback Rv. [DIZ;SS]
		147.600	Maint. Break
		147.800	Hoback Rv. [BRZ;SS]
SB 02C		148.776	Cliff Cr. [BSA;SS]
3039		150.947	Hoback Rv. [BSB;SS]
		151.260	Hoback Rv. [BSC;SS]
		152.026	Hoback Rv. [BSD;SS]
		153.756	Hoback Rv. [BSE;SS]

Maint.

Section	class	RM	WY 28
CREW			ML - 14B
-cont-			from Sweetwater county
SW 07A	6	20.678	Sweetwater Co. Line
3037		24.408	Fremont Co. Line
			District Boundary

WY 235

Section	class	RM	WY 235
			ML - 1203B
-cont-			from Lincoln county
LN 07A	7	3.893	Lincoln Co. Line
3041		3.991	Unnamed Draw
		4.486	Calpet
			End SHS

WY 350

Section	class	RM	WY 350
			ML - 1800B
SB 05A	7	0.000	US 189 (RM 105.94)
3041		1.390	WCL Big Piney
		5.055	End SHS

WY 351

Section	class	RM	WY 351
			ML - 1801B
	7	0.000	US 189 (RM 109.38)
SB 06A		0.386	Muddy Cr. [CVE;SS]
3035		7.298	Green Rv. [CVF;SS]
		12.891	New Fork Rv. [KFL;SS]
		12.910	Paridise Rd
		24.181	US 191/189 (RM 76.75)

WY 352

Section	class	RM	WY 352
			ML - 352B
	7	0.000	US 191/189 (RM 105.54)
SB 07A		0.124	BK= - 0.012 mi.
3035		0.136	AH Equation
		4.180	Cora
		7.800	Forty Rod Rd
		22.212	Bridger Nat'l. Forest Boundary
		23.678	Bridger Nat'l. Forest Boundary
		25.313	End SHS @
			Bridger Nat'l. Forest Boundary

Maint.

Section	class	RM	WY 353
CREW			ML - 1804B
	7	0.000	US 191/189 (RM 87.80)
SB 08A		2.330	Unnamed Draw [IMW;SS]
3035		6.700	Silver Cr.[CVH;SS]
		14.400	East Fork Rv. [CVI;SS]
		15.511	End SHS



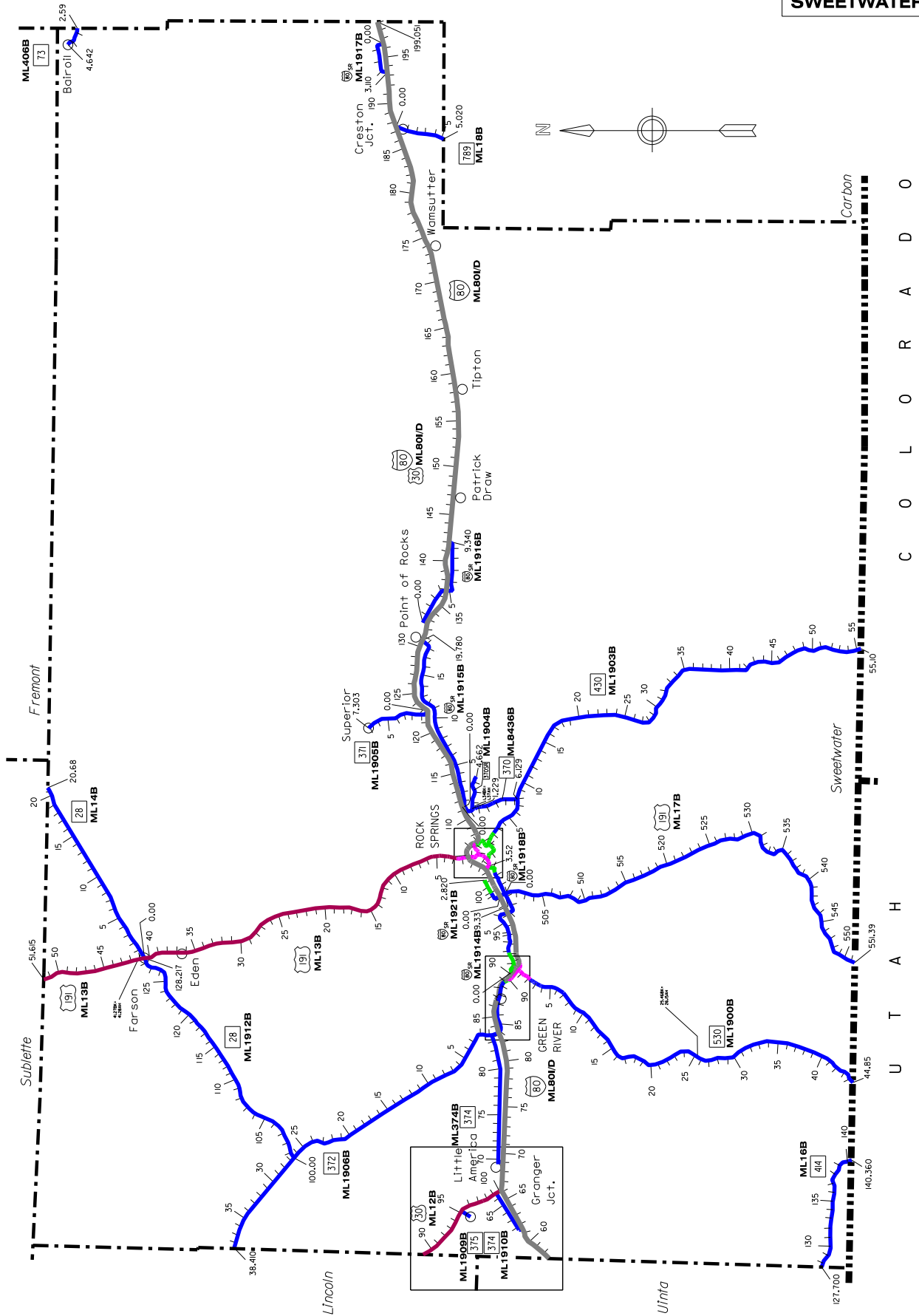

WY 354

Section	class	RM	WY 354
			ML - 354B
SB 09A	7	0.011	US 191/189 (RM 110.75); Daniel Jct.
3035		1.258	Green Rv. [CVJ;SS]
		6.178	End SHS



S U B L E T T E C O U N T Y F R E M O N T C O U N T Y L I N C O L N C O U N T Y U I N T A C O U N T Y

ROAD COLOR TABLE

	Rural & Urban Interstate #'s "1 & 11"
	Urban Principal Arterial Other & Expressway (NHS) #'s "12 & 14"
	Urban Minor Arterial, Collector & Local (non NHS) #'s "16, 17 & 19"
	Rural Principal Arterial Other (NHS) # "2"
	Rural Minor Arterial, Major & Minor Collectors & Local (non NHS) #'s "6, 7, 8 & 9"

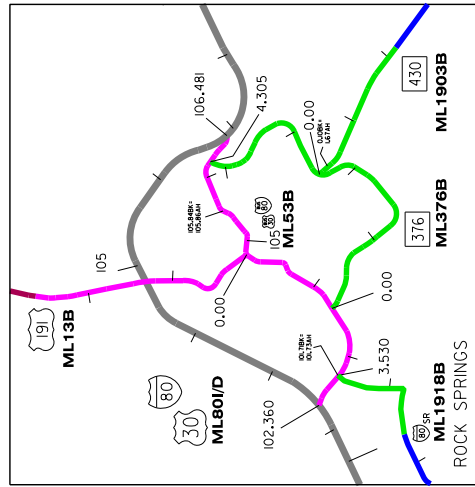
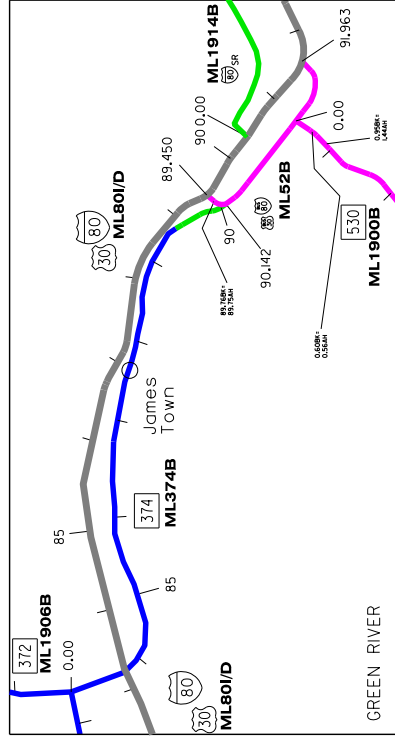
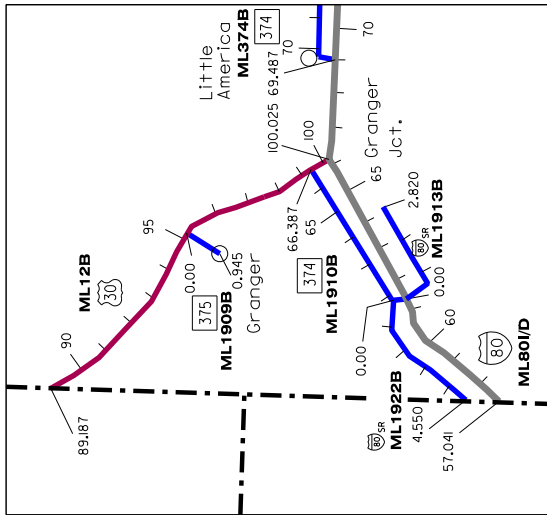

Sweetwater

County 4

— class "classification break"

+ Indicates Non State System

Maint. Section	class	RM	I-80. US 30 & WY 789
CREW			ML - 80
	1	57.041	Uinta Co. Line
SW 01C		58.863	Machinery Pass Sep. [AOG;EB, AOH;WB]
	3038	61.591	WY 374 (RM 61.59); Cedar Mtn Rd Int. [AOI;EB, AOJ;WB]
		66.168	US 30 (RM 100.03); Granger Jct. Int. [CWL;NB, IYG;SB], Begin US 30
		68.972	WY 374 (RM 69.49); Little America Int. [AOL;EB, AOM;WB]
		69.700	WB C.M.Sign (dynamic)
		72.296	Westvaco Int. [AON;EB, AOO;WB]
		76.627	UPRR Maint. Sep. (Under)
		77.343	Machinery Pass Sep. [AOP;EB, AOQ;WB]
		77.478	Black's Fork Rv. [AOR;EB, AOS;WB]
		79.542	Co. Rd Sep. [AOT;EB, AOU;WB]
	82.307	UPRR Sep. (Under) [AOV;EB, AOW;WB]	
		Peru Hill RWIS site {1}	
	→	83.007	WY 372 (RM 0.00); LaBarge Int. & WY 374 (RM 83.67), [CXU;SS]
		85.697	Covered Wagon Rd Int. [AOX;EB, AOY;WB]
SW 01D	3031	86.380	Green Rv. [AOZ;EB, APA;WB]
		87.459	Blue Rim Rd Sep. [APB;EB, APC;WB]
		88.800	EB VSL signs
	1	88.900	EB C.M.Sign (dynamic)
	—	89.000	WUL Green Rv.
	11		E.B. Road Close Gate R/R
		89.445	I80/US 30 BUS (RM 89.45); W. Green River Int. [KED;EB, KEE;WB]
		89.500	EB C.M.Sign (dynamic)
		89.647	WCL Green Rv.
		89.693	Co. Rd Sep. [APG;EB, APH;WB]
		EB C.M.Sign (dynamic)	
	90.080	EB VSL signs	
	90.214	Tunnel [API;EBT, API;WBT]	
	90.450	WB VSL signs	
	90.500	Cemetery Separation RWIS site {25}	
	90.648	Cemetery Rd Sep. [APK;EB, APL;WB]	
		WB C.M.Sign (dynamic)	
	91.000	W.B. Road Close Gate R/R	
	91.532	I80/US 30 BUS (RM 91.96); E. Green River Int. [LEU;EB, LEV;WB]	
	92.654	ECL & EUL Green River	
	92.750	EB VSL signs	
	92.800	WB C.M.Sign (dynamic)	
	97.000	WB C.M.Sign (dynamic)	
11	→	97.055	Machinery Pass Sep. [APP;EB, APQ;WB]

→ -cont- next column

Maint. Section	class	RM	I-80. US 30 & WY 789
CREW			ML - 80
			(CONTINUED)
	11	97.900	Rock Springs West RWIS site {26}
			WB VSL signs
		99.900	EB VSL signs
SW 01D	3031	99.138	US 191 (RM 500.00); Flaming Gorge Int. [CVS;SS]
		100.270	WUL Rock Springs
		101.162	Stock Drive Underpass [APR;SS]
		101.449	WCL Rock Springs
		101.687	WB VSL signs
		101.710	BK= - 0.041 mi.
		101.728	AH Equation
		101.986	Alkali Flat [APS;SS]
		102.358	I-80/US 30 BUS (RM 102.36); Dewar Dr Int. [LYB;EB, LYC;WB]
		103.200	EB & WB VSL signs
	103.820	College Drive Int. [FHW;SS]	
	104.500	EB & WB VSL signs	
	104.674	UPRR & Co. Rd Killpecker Cr. Sep. (Under) [LRY;WB, LRX;EB]	
	→	104.825	US 191 (RM 1.32); Elk Street Int. [LEN;WB, LEM;EB]
	105.199	CL Rock Springs	
SW 01G	3032	105.730	EB VSL signs
		105.858	Co. Rd Sep. [LYN;EB, LYO;WB]
		106.357	CL Rock Springs
		106.701	Swanson Rd Sep. [LYD;EB, LYE;WB]
		106.800	WB VSL sign
		107.056	I-80 & US 30 BUS (RM 106.48); Pilot Butte Int. [LYF;EB, LYG;WB]
	11	107.259	ECL Rock Springs
	—	107.720	EUL Rock Springs
	1	110.300	EB & WB C.M.Sign (dynamic)
			WB VSL signs
	110.801	Gunn Draw [AQK;EB, AQL;WB]	
	111.161	WY 370 (RM 0.00); Baxter Rd Int. [AQM;EB, AQN;WB]	
		E.B. Road Close Gate R/R	
	111.500	Baxter Rd. RWIS site {27}	
	117.392	Dry Lake Stockpass [AQO;EB, AQP;WB]	
	118.661	Machinery Pass Sep [AQQ;EB, AQR;WB]	
	→	122.272	WY 371 (RM 0.00); Superior Int. [AQS;EB, AQT;WB]
SW 01E	3043	124.308	Machinery Pass Sep [AQU;EB, AQV;WB]
		124.500	MM 124.5 RWIS site {28}
		127.552	Machinery Pass Sep [AQW;EB, AQX;WB]
	1	129.800	Point of Rocks RWIS site {29}

→ -cont- next page

Maint. Section	class	RM	I-80. US 30 & WY 789
CREW		ML - 80	
-cont-		<i>(CONTINUED)</i>	
		130.840	Point of Rocks Int. [AQY;EB, AQZ;WB] Remote Loader site PD 981
	1	132.278	10 Mile Draw [ARA;SS]
SW 01E		132.592	UPRR Sep. (Over) (Jim Bridger Spur)
3043		135.045	Black Butte CO. Rd [ARC;EB, ARD;WB]
		136.958	County Rd Sep. [ARE;EB, ARF;WB]
		139.509	Red Hill Int. [ARG;EB, ARH;WB]
		141.830	Bittercreek RWIS site {30}
		142.170	Bitter Cr. Int. [ARI;EB, ARJ;WB]
		143.500	Bitter Cr. Rest Area WBL SW 80R
		144.200	Bitter Cr. Rest Area EBL SW 80S
		145.257	Co. Rd Sep. [ARK;EB, ARL;WB]
		146.848	Patrick Draw Int. [ARM;EB, ARN;WB] Dept. Shop Patrick Draw PD 03A
		148.089	Co. Rd Sep. [ARO;EB, ARP;WB]
		150.807	Table Rock Int. [ARQ;EB, ARR;EB]
		152.455	Bar X Int. [ARS;EB, ART;WB]
		154.060	BLM Rd Int.
		156.030	G.L. Rd Int.
		156.720	Tipton RWIS site {31}
	1	158.545	Tipton Int. [ARW;EB, ARX;WB] Remote loader site WS 981
		165.582	Red Desert Int. [ARY;EB, ARZ;WB]
		165.710	Unnamed Draw [MFK;SS]
SW 01A		166.920	Booster Rd
3044		168.940	Frewen Rd
		170.680	Rasmussen Rd Int. [LZR;EB, LZS;WB]
		172.362	Machinery Pass Sep. [ASD;EB, ASE;WB]
		173.413	Wamsutter Int. [LZT;EB, LSU;WB] Dept. Shop Wamsutter WS 03A
		173.886	Co. Rd Sep. [LZV;EB, LZW;WB]
		177.516	Latham Draw
		180.677	Machinery Pass Sep. [ASL;EB, ASM;WB]
		184.270	Continental Divide RWIS site {32}
		184.288	Cont. Divide Int. [ASN;EB, ASO;WB]
		187.204	WY 789 (RM 0.00); Creston Jct. Int. [ASP;EB, ASQ;WB], Begin WY 789 District Boundary
SW 01B		187.430	W.B. Road Close Gate R/R
1041		193.041	Piker Springs Sep. [ASR;EB, ASS;WB]
		193.287	Piker Springs Cr. [AST;EB, ASU;WB]
		196.157	Riner Int. [ASV;EB, ASW;WB]
		197.956	Machinery Pass Sep [ASX;EB, ASY;WB]
		198.447	Filmore Cr. [ASZ;EB, ATA;WB]
	1	199.051	Carbon County Line

Maint. Section	class	RM	I-80 & US 30 BUS
CREW		ML - 52B	
	14	89.450	I-80 (RM 89.45); W. Green River Int. [KED;EB, KEE;WB]
		89.600	WCL Green River
SW 14Z			End Divided Section
3031		89.693	WY 374 (RM 90.14)
		91.100	UPRR Sep. (At Grade Serv. Rd.)
		91.220	WY 530 (RM 0.00)
		91.650	Begin Divided Section
		91.963	I-80 (RM 91.53); E. Green River Int. [LEU;EB, LEV;WB]
		I-80 & US 30 BUS	
		ML - 53B	
	14	102.360	I-80 (RM 102.36); Dewar Drive Int. [APV;EB, APW;WB]
SW 15Z		103.587	WY 376 (RM 0.00)
3031		103.750	BK= - 0.019 mi.
		103.769	AH Equation
		104.290	Bitter Cr. [FSE;SS]
		104.800	RR at Grade Crossing #810360J
		104.830	US 191 (RM 0.00)
		105.250	Bitter Cr. [DKE;SS]
SW 15Y		105.842	BK= - 0.018 mi.
3032		105.860	AH Equation Ninth St.
		106.087	WY 376 (RM 4.31)
		106.312	Begin Divided Section
	14	106.481	I-80 (RM 107.06); Pilot Butte Int. [AQH;EB, AQI;WB]
		US 30	
		ML - 12B	
	2	89.190	Lincoln Co. Line Cont. NHS
SW 03A		93.850	Dept. Shop - Granger GN 03A
3038			Off System Approx. 0.5 mi. S.
		94.855	NCL Granger
		95.173	UPRR Sep. (Under) [JBB;SS]
		95.342	WY 375 (RM 0.00)
		95.546	Black's Fork Rv. [JBC;SS]
		96.135	SCL Granger
		99.539	WY 374 (RM 66.39)
		100.025	I-80 (RM 66.17); Granger Jct. Int. [CWL;NB, IYG;SB] End NHS

Maint. Section	class	RM	US 191
			ML - 13B
	14	0.000	I-80 BUS (RM 104.83)
SW 04Z		0.100	Bitter Cr. [DNR;SS]
3032		0.640	(old) Dept. Shop
		1.315	I-80 (RM 104.83); Elk Street Int.
			[AQA;WB, LEM;EB]
	14	2.274	NCL Rock Springs
SW 04A		2.560	NB C.M.Sign (dynamic)
3032	2	2.300	NUL Rock Springs
		2.900	Dept. Shop - Rock Springs DH 03A
			North Yard (Dept.)
			Remote loader site RS 981
		4.509	Reliance Rd
		4.540	RR at Grade Crossing #810356U
		4.695	Killpecker Cr. [BRJ;SS]
		12.120	Maint. Break
SW 04B		13.140	Blue Rim Rd
3037		36.110	Eden
		39.816	Little Sandy Rv. [BRK;SS]
		40.453	WY 28 (RM 0.00) ML 14B
			WY 28 (RM 128.22) ML 1912B
			RWIS site {62}
			Farson
		40.801	Big Sandy Rv. [BRL;SS]
		41.000	Dept. Shop - Farson FS 03A
		41.272	BK= - 0.011 mi.
		41.283	AH Equation
		41.960	Farson Cutoff Rd
		42.460	County Rd
		49.060	Eden Reservoir Rd
	2	51.615	Sublette Co. Line

Maint. Section	class	RM	US 191
			ML - 17B
	6	500.000	I-80 (RM 99.14); Flaming Gorge Int.
SW 13A			[CVS;SS]
3031		500.303	UPRR Sep. (Under) [CWA;SS]
		500.620	Bitter Cr. [CWB;SS]
		500.800	SB C.M.Sign (dynamic)
		502.460	S.B. Road Close Gate R/R
		513.182	County Reservoir Rd
		550.680	Basin Rd
		551.388	Utah State Line
		244.200	NB C.M.Sign (dynamic)
			<i>Across state line</i>

Maint. Section	class	RM	WY 28
			ML - 14B
	6	0.000	US 191 (RM 40.45)
SW 07A			& WY 28 (RM 128.22) Farson
3037		0.700	EB C.M.Sign (dynamic)
		3.231	Little Sandy Rv. [DZW;SS]
		4.400	Eden Reservoir Rd
		5.350	E.B. Road Close Gate R/R
		6.167	Eden Canal [FBD;SS]
		20.678	Sublette Co. Line
			-cont- in Sublette Co.

Maint. Section	class	RM	WY 28
			ML - 1912B
	7	100.000	WY 372 (RM 26.76)
SW 18A		100.020	Remote loader site FS 981
3037		102.805	Green River [FBS;SS]
		128.970	Big Sandy Rv. [FFC;SS]
		128.217	US 191 (RM 40.45)
			& WY 28 (RM 0.00) Farson

Maint. Section	class	RM	WY 73
			ML - 406B
-cont-			from Carbon county
CB 14A	7	2.587	Carbon Co. Line
2036		4.310	Bairoil Corp. Limits
		4.642	Bairoil
			End SHS

Maint. Section	class	RM	WY 370
			ML - 1904B
	7	0.000	I-80 (RM 111.16); Baxter Rd Int.
SW 10A			[AQM;EB, AQN;WB]
3032		0.060	I-80 SR ML1915
		0.661	UPRR Sep. (Under) [DCL;SS]
		1.040	Bitter Cr. [EOT;SS]
		1.229	WY 370 -cont-'s on ML8436
			-cont- WY 370 SR

Maint. Section	class	RM	WY 370
			ML - 8436B
			<i>(CONTINUED)</i>
	7	1.229	WY 370 (RM 1.229)
SW 10B		2.261	Unnamed Draw
3032		5.172	Unnamed Draw
		6.129	WY 430 (RM 7.835)

Maint. Section	class	RM	WY 371
			ML - 1905B
SW 11A	7	0.000	I-80 (RM 122.27); Superior Int. [AQS;EB, AQT;WB]
3043		6.779	SCL Superior
		7.160	NCL Superior
		7.303	End SHS

Maint. Section	class	RM	WY 372
			ML - 1906B
SW 12A	7	0.000	WY 374 (RM 83.56)
3038		12.670	RR at Grade Crossing #810373K
		12.900	Soda Ash Rd
		26.758	WY 28 (RM 100.00)
SW 12B	7	26.800	Maint. Break
3041		33.700	Exxon Rd
		36.010	Shute Creek RWIS site {60}
		38.409	Lincoln County Line

-cont- in Lincoln Co.

Maint. Section	class	RM	WY 374
			ML - 374B
SW 02A	7	69.487	I-80 (RM 68.97); Little America Int. [AOL;EB, AOM;WB]
3038		69.582	Little America Rd
		72.165	Unnamed Draw [BKB;SS]
		72.310	FMC Rd
		72.910	Tenneco Rd
		73.960	Allied Rd
		77.300	UPRR Sep. (Over) [FEI]
		78.127	Black's Fork Rv. [BKC;SS]
		81.090	Unnamed Draw [DEB;SS]
		82.667	UPRR Sep. (Under) [BKD;SS]
		83.555	WY 372 (RM 0.00)
		83.670	I-80 (RM 83.01); LaBarge Int. [CXU;SS]
SW 02B	7	86.330	Class Break
3031	6	87.165	Green River [CXW;SS]
		88.149	Greasewood Draw [CXV;SS]
		88.595	Unnamed Draw [CHM;SS]
		89.470	WUL Green River
	16	90.030	WCL Green River
		90.142	I 80 BUS (RM 89.69)

Maint. Section	class	RM	WY 374
			ML - 1910B
SW 02C	7	61.590	I-80 (RM 61.59); Cedar Mtn Rd Int. [AOI;EB, AOJ;WB]
3038		66.387	US 30 (RM 99.54)

Maint. Section	class	RM	WY 375
			ML - 1909B
SW 16A	7	0.000	US 30 (RM 95.34)
3038		0.945	Granger

Maint. Section	class	RM	WY 376
			ML - 376B
SW 17Z	16	0.000	US 30 BUS (RM 103.59)
3032		0.080	Bitter Cr. [DBP;SS]
		0.260	UPRR Sep. [DBL;SS]
		1.280	SCL Rock Springs
		1.460	SCL Rock Springs
		2.350	WY 430 (RM 0.00)
		2.520	Hampshire St. Overpass [DEU;SS]
		2.600	UPRR Maint. Sep. (Under) [DET;SS]
		4.090	UPRR & Bitter Cr. Sep. (Under) [DEW;SS]
		4.310	US 30 BUS (RM 106.09)

Maint. Section	class	RM	WY 414
			ML - 16B
UI 10A	7	127.696	from Uinta county Uinta Co. Line
3042		130.027	Burnt Fork Cr. [CGZ;SS]
		140.360	Utah State Line

Maint. Section	class	RM	WY 430
			ML - 1903B
SW 09Z	16	0.000	WY 376 (RM 2.35); Merchant St.
3032		0.074	Old Highway
		0.098	BK= - 1.576 mi.
		1.674	AH Equation
	16	1.806	Dead Horse Canyon Cr.[CVV;SS]
		2.224	SCL & SUL Rock Springs
		7.835	WY 373 (RM 7.835)
SW 09A	7	15.501	Salt Wells Cr. [CVW;SS]
3032		30.139	North Alkali Cr. [CVX;SS]
		55.100	Colorado State Line

Maint. Section	class	RM	WY 530
ML - 1900B			
SW 08Z	14	0.000	I 80 BUS (RM 91.22)
3038		0.319	UPRR Sep. (Under) [DDH;SB, JQL;NB]
		0.597	BK= + 0.039 mi.
		0.558	AH Equation
		0.776	Green River [CVL;NB, DNJ;SB]
		0.948	BK= - 0.489 mi.
	14	1.437	AH Equation
		2.737	SCL & SUL Green River
SW 08A	7	14.020	Black's Fork Rv. [CDA;SS]
3038		24.290	Unnamed Draw [KSW;SS]
		24.975	Buckboard Wash
		25.457	BK= - 0.776 mi.
		26.233	AH Equation
		29.390	Dry. Cr.
		31.149	Squaw Hollow
		31.600	Squaw Hollow Rd
		32.893	BK= +0.03 mi
		32.863	AH Equation
		35.152	Reservoir Draw
		36.511	Anvil Draw
		37.070	Anvil Wash
		37.551	Unnamed Draw
		39.034	Twin Buttes Draw
		44.208	Henry's Fork Rv. [CVT;SS]
	7	44.788	Utah State Line

WY 789			
ML - 18B			
SW 05A	6	0.000	I-80 9RM 187.20); Creston Jct. Int. [ASP;EB, ASQ;WB]
1037		0.200	S.B. Road Close Gate R/R
		1.339	UPRR Sep. (Under) [CLL;SS]
		5.018	Carbon Co. Line

I-80 SV. RD.			
ML - 1913B			
SW 01U	9	0.000	I-80 (RM 61.59)
3038		2.820	End Sv. Rd. @Dead End

I-80 SV. RD.			
ML - 1914B			
SW 21A	19	0.000	Cemetery Rd. Sep. I-80 (RM 90.65)
3031		1.940	CL & UL Green River
	9	7.220	Machinery Pass Sep. (RM 97.05)
		9.330	US 191 (RM 500.03)

Maint. Section	class	RM	I-80 SV. RD.
ML - 1915B			
SW 01K	9	0.000	WY 370 (RM 0.06)
3032		6.260	Bridge
		11.110	Maint. Break
SW 01L		12.100	Bridge
3043		14.820	Bridge
	9	19.780	Point of Rocks Int. I-80 (RM 130.84)

I-80 SV. RD.			
ML - 1916B			
SW 01T	9	0.000	From Jct. S-County 1911
3043		0.030	RR at Grade Crossing #810376F
		3.960	I-80 (RM 136.96); Black Butte Int.
		9.340	Bitter Creek Int. (RM 142.17)

I-80 SV. RD.			
ML - 1917B			
SW 01H	9	0.000	I-80 (RM 196.16); Riner Int. [ASV;EB, ASW;WB]
1041		2.870	Piker Cr. [KMY;WSR]
		3.110	Piker Springs Sep. (RM 193.04)

I-80 SV. RD.			
ML - 1918B			
SW 20A	8	0.000	US 191 (RM 500.08)
3031		1.150	UL Rock Springs
	16	2.360	CL Rock Springs
SW 20Z		3.530	US 30 BUS (RM 102.75)
3031			

I-80 SV. RD.			
ML - 1921B			
SW 01W	9	0.000	I-80 (RM 99.14); Flaming Gorge Int. [CVS;SS]
3031		1.280	UL Rock Springs
	16	2.820	CL Rock Springs
			Alkali Flat [APT;SSR]
			End state maintenance
		3.220	Dewar Dr.

I-80 SV. RD.			
ML - 1922B			
SW 01N	9	0.000	WY 374 (RM 61.59)
3038		4.550	Uinta County Line

ML - 1904B			
-cont-			from WY 370
SW 10A	*	1.343	BK= - 0.021 mi.
3032	*	1.367	AH Equation
	*	4.400	Airport
	*	4.662	End SHS

* this portion to be given to Sweetwater County within the next couple years.

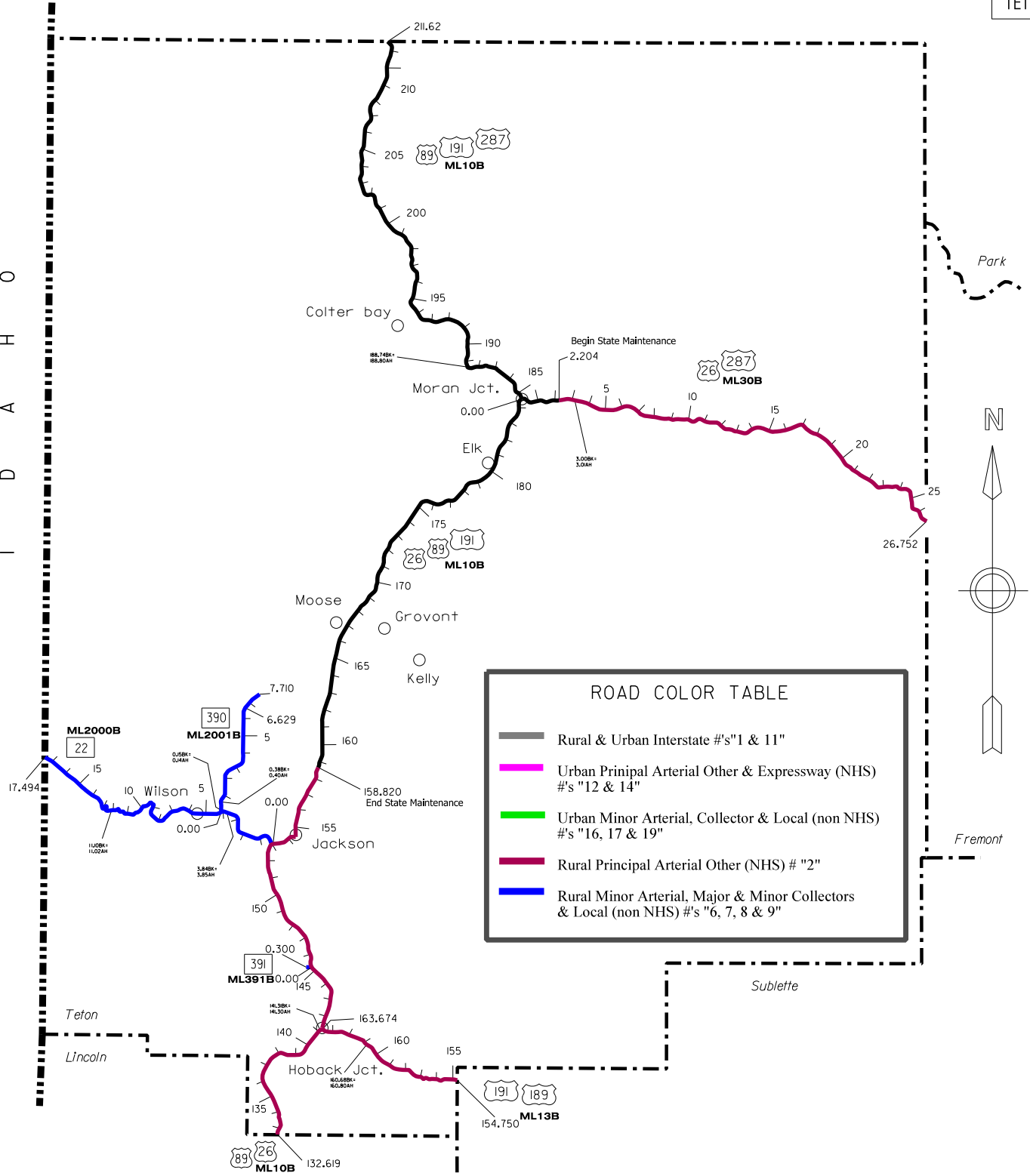

Teton

County 22

class "classification break"

+ Indicates Non State System

Maint. Section	class	RM	US 26/89/189/191/287
CREW		ML - 10B	
	2	132.619	Lincoln Co. Line Cont. NHS
TE 01A		136.232	Dog Cr.
3039		136.420	Bridger & Teton Nat'l. Forest
		137.080	W.B. Road Close Gate R/R
		140.604	Fall Cr. [BOJ;SS]
		140.850	Bridger & Teton Nat'l. Forest
		141.079	Snake Rv. [BOK;SS]
		141.310	US 189/191 (RM 163.67); Hoback Jct. Begin US 189 & 191
		141.500	SB C.M.Sign (dynamic)
		142.781	Snake Rv. [BOL;SS]
		145.250	WY 391 (RM 0.00) Dept. Shop Jackson JK 03A
		145.639	Bridger & Teton Nat'l. Forest
		146.090	Snake Rv. [BOM;SS]
		146.387	Flat Cr. [BON;SS]
		147.226	Bridger & Teton Nat'l. Forest
		147.303	Bridger & Teton Nat'l. Forest
		148.710	S. Park Rd
		149.762	Bridger & Teton Nat'l. Forest
		150.101	Bridger & Teton Nat'l. Forest
		151.880	SCL Jackson
		152.050	High School Rd
		152.090	Maint. Break
		152.159	Flat Cr. [BOO;SS]
TE 01Z		152.520	CL Jackson
3039		153.000	NB C.M.Sign (dynamic)
		153.045	WY 22 (RM 0.00)
		153.920	CL Jackson
		153.100	SB C.M.Sign (dynamic)
		153.976	Flat Cr. [BOP;SS]
		154.460	End US 189
		154.870	City Shop
		154.930	Jackson Info. Center
		154.982	S. Boundary Elk Refuge
		155.120	Flat Cr. [FFG;SS]
		155.213	NCL Jackson
TE 01B			Bridger & Teton Nat'l. Forest
3039	2	158.818	Grand Teton Nat'l. Park Boundary N. Boundary Elk Refuge

-cont- next column

Maint. Section	class	RM	US 26/89/189/191/287
CREW		ML - 10B	
		(CONTINUED)	
		(End of State Maintenance Responsibility)	
		+ 158.818	Grand Teton Nat'l. Park Boundary N. Boundary Elk Refuge
		+ 160.735	Gros Ventre Rv.
		+ 160.991	N. Branch Gros Ventre Rv.
		+ 161.340	Kelly Rd
		+ 162.840	Airport Rd
		+ 166.791	Moose Rd
		+ 180.386	Creek
		+ 180.763	Spread Cr.
		+ 184.401	Buffalo Fork Rv.
		+ 184.581	US 26/287 (RM 0.00); Moran Jct. End US 26 (*State Hwy.*) Begin US 287 (*Park SV. Hwy.*) End NHS
		+ 185.456	Pacific Cr.
		+ 188.514	Begin Divided Section
		+ 188.571	Old Rd
		+ 188.672	End Divided Section
		+ 188.742	BK= - 0.06 mi.
		+ 188.802	AH Equation
		+ 189.479	Jackson Lake Lodge Bridge
		+ 191.702	Pilgrim Cr.
		+ 194.150	Colter Bay Rd
		+ 198.890	Arizona Cr.
		+ 204.849	Grand Teton Nat'l. Park Boundary Teton Nat'l. Forest Boundary
		+ 209.180	Snake Rv.
		+ 211.621	Yellowstone Nat'l. Park Boundry S. Entrance
		US 26 & US 191/189 Wye Connector	
		ML - 2004B	
TE 01N	2	141.160	US 26,89,189,191/287 (RM 141.30)
3039		141.290	US 191/189 (RM 163.67)

**Maint.
Section**

CREW

class

RM

US 26/287

ML - 30B

+	0.000	US 26,89,189,191/287 (RM 184.58) ; Moran Jct. Begin NHS
+	2.190	End of Non-State system
2	2.204	Begin State Maint. District Boundary Teton Nat'l. Park Forest Boundary
	2.729	Lava Cr. [EWQ;SS]
	3.510	Buffalo Valley Rd
	3.593	Buffalo Fork Rv. [LWC;SS]
	3.654	Grand Teton Nat'l. Park Boundary Forest Boundary
	4.567	Grand Teton & Teton Nat'l. Forest Boundary
	7.829	BK= +0.309 mi
	7.520	AH Equation
	8.400	E.B. Road Close Location R/R
	8.440	Black Rock Cr. [MHM;SS]
	10.621	Unnamed Draw [MHQ;SS]
	24.140	Unnamed Draw [MBJ;SS]
	25.328	Teton & Shoshone Nat'l. Forest Boundary
	26.752	Fremont Co. Line Cont. NHS

TE 03A

5033

US 191/189

ML - 13B

2	154.750	Sublette Co. Line
	154.800	Hoback Rv. [BSF;SS]
	156.506	Hoback Rv. [BSG;SS]
	157.960	Hoback Rv. [BSH;SS]
	160.676	BK= - 0.119 mi.
	160.795	AH Equation
	163.674	US 26/89/189/191/287 (RM 141.30) Hoback Jct.

TE 02A

3039

Maint.

Section

CREW

class

RM

WY 22

ML - 2000B

ID 31	0.010	EB C.M.Sign (dynamic) <i>Across state line</i>
ID 33	150.700	EB C.M.Sign (dynamic) <i>Across state line</i>
6	0.000	US 26/89/89 (RM 153.05)
TE 04A	0.660	Spring Gulch Rd
3039	3.755	Snake Rv. [BMV;SS]
	4.055	WY 390 (RM 0.00)
	5.400	Fish Cr. [CEA;SS]
	5.530	Wilson
	6.500	NB C.M.Sign (dynamic)
	6.920	W.B. Road Close Gate R/R
	6.986	Teton Nat'l. Forest Boundary
	11.097	BK= + 0.076 mi.
	11.021	AH Equation Teton & Targhee Nat'l. Forest Boundary
	11.170	Teton Pass RWIS site {61}
	17.480	E.B. Road Close Gate R/R
	17.494	Idaho State Line

WY 390

ML - 2001B

7	0.000	WY 22 (RM 4.06)
	0.149	BK= + 0.011 mi.
	0.138	AH Equation
	0.382	BK= - 0.018 mi.
	0.400	AH Equation
	2.260	Cheney Lane
7	3.840	Granite Cr. [LME;SS]
●	6.629	Class. Break
9	6.490	Teton Village Rd
	6.631	WY-390
	7.550	Granite Cr. [FOM;SS]
9	7.710	Grand Teton Nat'l. Park Boundary End SHS

TE 05A

3039

WY 391

ML - 391B

TE 06A	8	0.000	US 26,89 (RM 145.25)
3039		0.300	End @Jackson Dept. Shop

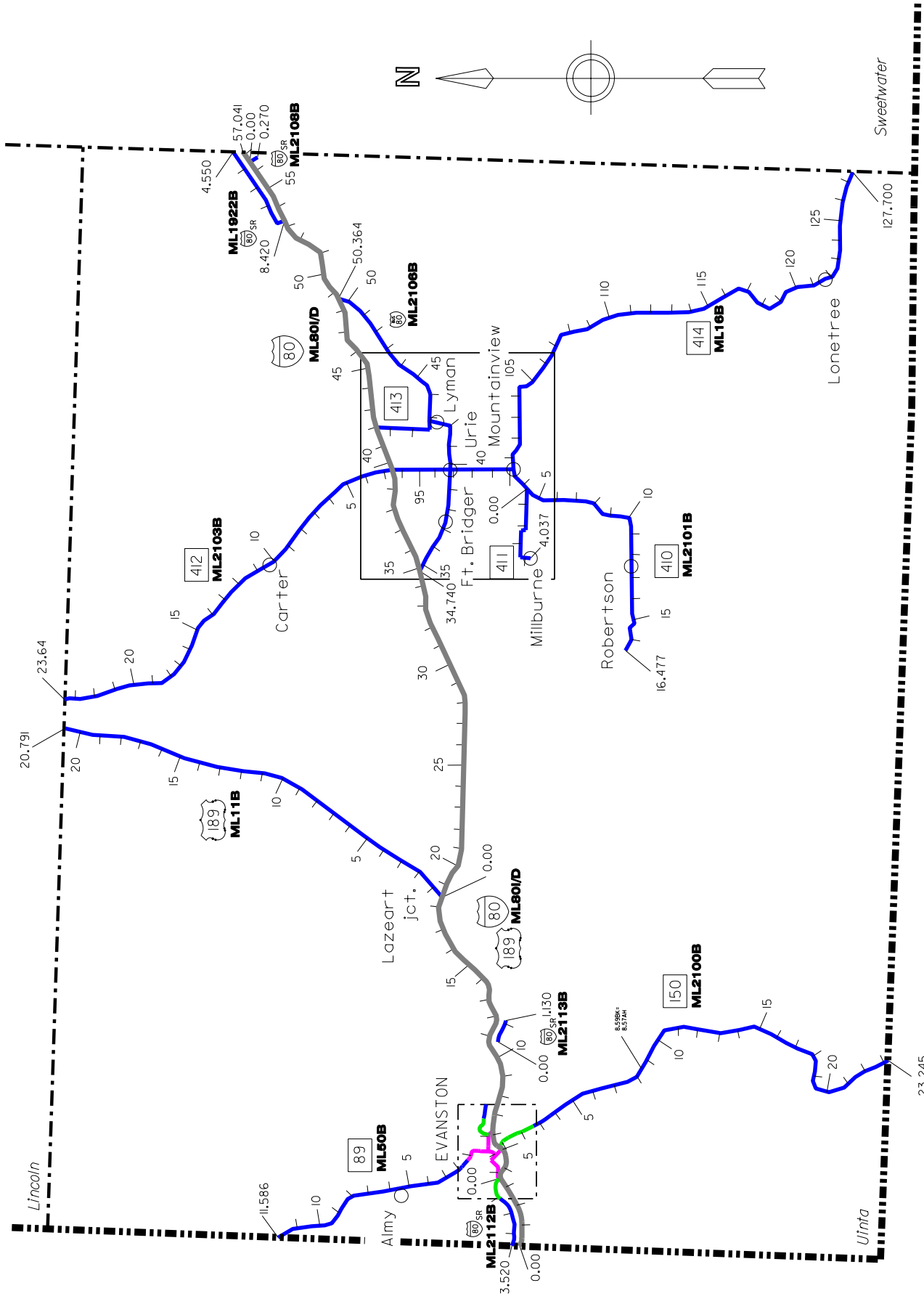

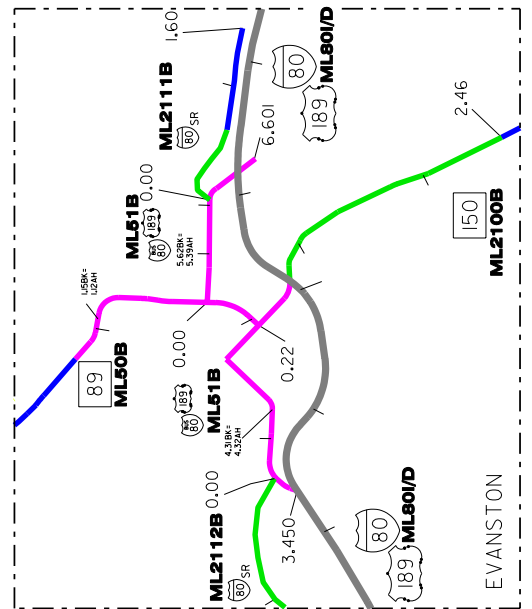
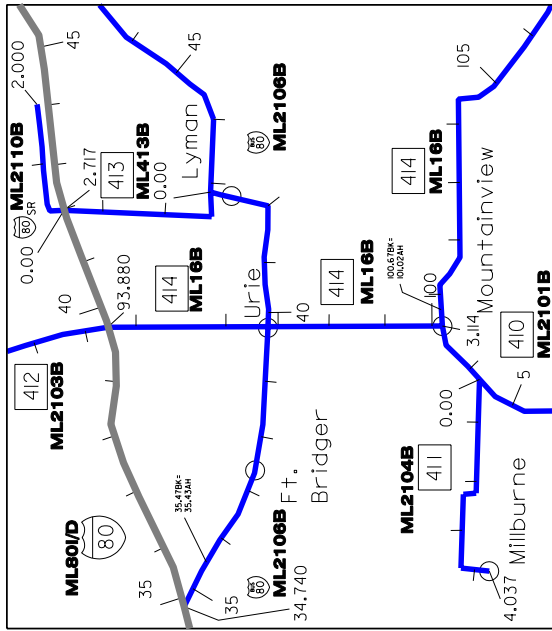

ROAD COLOR TABLE

- Rural & Urban Interstate #'s "1 & 11"
- Urban Principal Arterial Other & Expressway (NHS) #'s "12 & 14"
- Urban Minor Arterial, Collector & Local (non NHS) #'s "16, 17 & 19"
- Rural Principal Arterial Other (NHS) # "2"
- Rural Minor Arterial, Major & Minor Collectors & Local (non NHS) #'s "6, 7, 8 & 9"

Uinta

class "classification break"

County 19

Maint. Section	class	RM	I-80 & US 189
		ML - 80	
		194.300	EB C.M.Sign (dynamic)
			<i>Across state line</i>
	1	0.000	Utah State Line
	1	0.400	Evanston Port-of-Entry UI 01P
	●	2.180	WUL Evanston
UI 01A	11	2.820	WCL Evanston
3036		3.453	I-80/US 189 BUS (RM 3.45); W. Evanston Int. [AMF;EB, AMG;WB]
		4.200	Evanston RWIS site {22}
		4.513	Yellow Cr. Rd Sep. [AMH;EB, AMI;WB]
		5.263	WY 150 (RM 0.65); State Hospital Rd Int [FGR;EB, FGS;WB]
		5.911	Bear River & UPRR Sep. [AML;EB, AMM;WB]
		6.257	I-80/US 189 BUS (RM 6.43); E. Evanston Int. [AMN;EB, AMO;WB]
			Evanston Info. Center
	11	6.700	ECL Evanston
	●	6.767	EUL Evanston
	1	7.000	E.B. Road Close Gate R/R
		7.100	EB C.M.Sign (dynamic)
		7.500	WB C.M.Sign (dynamic)
		8.450	EB VSL sign
		10.160	WB VSL sign Painter Int. RWIS site {63}
		10.683	Painter Int. [AMQ;EB, AMR;WB]
		11.860	EB VSL sign
		12.652	Machinery Pass Sep. [AMS;EB, AMT;WB]
		13.450	WB VSL sign
		13.862	Divide Int. [AMU;EB, AMV;WB] First Divide RWIS site {23}
		14.590	EB VSL sign
		15.640	Guild Sep. [AMW;EB, AMX;WB]
		16.871	Machinery Pass Sep. [AMY;EB, AMZ;WB]
		17.660	WB VSL sign US 189 RWIS site {64}
		18.293	US 189 (RM 0.00); US 189 Int. [ANA;EB, ANB;WB], End US 189 Remote loader site ET 981
		19.000	EB VSL sign
		20.950	WB VSL sign Coal Road RWIS site {65}
		21.050	EB VSL sign
		21.750	Coal Int.
		23.120	Bar Hat Int.
		23.350	WB VSL sign Leroy Int. RWIS site {66}
		23.604	UPRR Sep. (Under) [ANE;EB, ANF;WB]
		23.906	Leroy Int. [ANG;EB, ANH;WB]

-cont- next column

Maint. Section	class	RM	I-80 & US 189
		ML - 80	
			<i>(CONTINUED)</i>
-cont-			
UI 01A	1	24.560	EB VSL sign
3036		27.600	WB VSL sign French Int. RWIS site {67}
		28.290	Maint. Break
	1	28.710	French Int.
UI 01B		30.398	Bigelow Int. [ANJ;EB, ANK;WB] Remote loader site LM 981
3042		33.180	Union Int.
		34.740	I-80 BUS (RM 34.74); Ft. Bridger Int. [ANM;EB, ANN;WB]
		34.850	W.B. Road Close Gate R/R
		35.530	WB C.M.Sign (dynamic)
		37.020	Machinery Pass Sep. [ANO;EB, ANP;WB]
		39.896	WY 414(RM 93.88);Carter-Mt.View Int. [ANQ;EB, ANR;WB]
			& WY 412 (RM 2.81)
		41.987	WY 413 (RM 2.72); North Lyman Int. [ANS;EB, ANT;WB]
		41.990	Lyman Rest Area UI 01R
		44.850	Black's Fork Rv. [ANU;EB, ANV;WB]
		46.560	Co. Rd Sep. [ANW;EB, ANX;WB]
		47.430	Smith's Fork Cr. [ANY;EB, ANZ;WB]
		48.303	I-80 BUS(RM 50.36);Bridger Valley Int. [AOA;EB, AOB;WB]
		48.900	E.B. Road Close Gate R/R
		52.650	Church Butte RWIS site {24}
		53.306	Church Buttes Int. [AOC;EB, AOD;WB]
		56.717	Service Rd Sep. [AOE;EB, AOF;WB]
	1	57.041	Sweetwater Co. Line
			I-80 BUS
		ML - 2106B	
	6	34.740	I-80 (RM 34.74); Ft. Bridger Int. [ANM;EB, ANN;WB]
UI 11A		35.350	End 4-Lane Section
3042		35.466	BK= + 0.036 mi.
		35.430	AH Equation
		36.273	Black's Fork Rv. [LQU;SS]
		36.743	Little Black's Fork Rv. [LRC;SS]
		36.860	Groshon Cr. [BJY;SS]
		37.270	Ft. Bridger
		39.239	Lyman Canal [BJZ;SS]
		39.780	WY 414 (RM 96.69) Urie
		42.350	SCL Lyman

-cont- next page

Maint. Section

CREW	class	RM	I-80 BUS
			ML - 2106B
			(CONTINUED)
UI 11A	6	42.840	WY 413 (RM 0.00)
		43.310	Dept. Shop - Lyman LM 03A
3042		44.090	ECL Lyman
		48.720	Smith's Fork Rv. [BKA;SS]
		50.364	I-80 (RM 48.30); Bridger Valley Int. [AOA;EB, AOB;WB]

I-80 BUS & US 189 BUS

CREW	class	RM	I-80 BUS & US 189 BUS
			ML - 51B
UI 02Z	14	3.450	I-80 (RM 3.45); W. Evanston Int. [AMF;EB, AMG;WB]
		4.307	BK= - 0.017 mi.
3036		4.324	AH Equation
		5.128	WY 150 (RM 0.22)
		5.308	UPRR Sep. [FEM;SS]
		5.526	Bear Rv. [FEN;SS]
		5.578	WY 89 (RM 0.00)
		5.623	BK= + 0.229 mi.
		5.394	AH Equation
		6.434	I-80 (RM 6.26); E. Evanston Int.
		6.560	Dumcomb Hollow Drainage [FFJ;SS]
		6.601	End SHS @Rest Area

US 189

CREW	class	RM	US 189
			ML - 11B
UI 04A	6	0.000	I-80 (RM 18.29); US 189 Int. [ANA;EB, ANB;WB]
		0.764	Albert Cr. [FFZ;SS]
3036		18.900	Albert Cr. [FBA;SS]
		19.604	Little Muddy Cr. [FBB;SS]
		20.791	Lincoln Co. Line

WY 89

CREW	class	RM	WY 89
			ML - 50B
UI 03Z	14	0.000	US 189 BUS (RM 5.58)
		1.040	Dept. Shop - Evanston ET 03A
3036		1.153	BK= + 0.03 mi.
	14	1.122	AH Equation
	●	1.263	NCL & NUL Evanston
UI 03A	6	5.170	Almy
3036		5.491	Red Willow Cr. [DLU;SS]
		7.380	Whitney Canyon Rd
		7.988	Bear Rv. [DIM;SS]
		8.118	Bear Rv. Overflow [DIL;SS]
		8.340	SCL Bear River
		8.711	Chapman Canal [DIK;SS]
		9.510	NCL Bear River
	6	11.586	Utah State Line

Maint. Section

CREW	class	RM	WY 150
			ML - 2100B
	14	0.216	US 189 BUS (RM 5.13)
UI 05Z	14	0.500	2nd St
3036	●	0.651	I-80 (RM 5.26); State Hospital Rd Int. [FGR;EB, FGS;WB]
	16	1.150	Saddle Ridge Rd
		1.470	Aspen Groves Rd
		1.970	Hayden Ave
	→ 16	2.457	SCL Evanston
	●	2.670	SUL Evanston
	7	8.404	Bear Rv. [FHG;SS]
UI 05A		8.590	BK= + 0.02 mi.
3036		8.570	AH Equation
		9.950	Aspen Tunnel Rd
		14.900	Hillard Flat Rd
		19.120	Mill Cr [LNB;SS]
		19.460	Chalk Creek Rd
	7	23.245	Utah State Line

WY 410

CREW	class	RM	WY 410
			ML - 2101B
	7	3.114	WY 414 (RM 99.87)
UI 06A		3.856	SCL Mountain View
3042		4.004	Smith's Fork Cr. [CWF;SS]
		4.188	WY 411 (RM 0.00)
		12.345	Robertson
		12.765	Smith's Fork Cr. [CWG;SS]
		13.294	Willow Cr. [CWH;SS]
		15.253	Unnamed Draw [CWI;SS]
		15.306	Black's Fork Cr. [CWJ;SS]
		15.538	Black's Fork Cr. Overflow [CWK;SS]
		16.477	End SHS

WY 411

CREW	class	RM	WY 411
			ML - 2104B
	7	0.000	WY 410 (RM 4.19)
UI 07A		0.367	Smith's Fork Cr. [KSO;SS]
3042		2.320	Black Fork Canal [KSP;SS]
		3.228	Black's Fork Cr. Overflow [CWN;SS]
		3.257	Black's Fork Rv. [CGP;SS]
		4.037	Millburne
			End SHS

WY 412

CREW	class	RM	WY 412
			ML - 2103B
	7	2.806	I-80 (RM 39.90); Carter-Mtn View Int. [ANQ;EB, ANR;WB]
UI 08A			& WY 414 (RM 93.88)
3042		9.918	Big Muddy Cr. [JMZ;SS]
		10.330	RR at Grade Crossing #810478Y @Carter
		23.643	Lincoln Co. Line

-cont- In Lincoln Co.

Maint. Section	class	RM	WY 413
CREW			ML - 413B
UI 09A 3042	8	0.000	I-80 BUS (RM 42.84) NCL Lyman
		1.032	Rollins Rd
		2.341	Black's Fork Rv. [CWR;SS]
		2.718	I-80 (RM 41.99); N. Lyman Int.

Maint. Section	class	RM	WY 414
			ML - 16B
UI 10A 3042	7	93.880	I-80 (RM 39.90); Carter-Mtn View Int. [ANQ;EB, ANR;WB] WY 412 (RM 2.81)
		94.309	Black's Fork Rv. [FNA;SS]
		95.170	Bridger-Black fork Rd
		96.686	I-80 BUS (RM 39.78)
		99.100	NCL Mountain View
		99.870	WY 410 (RM 3.11)
		99.890	Smith's Fork Rv. [FQN;SS]
		100.659	BK= - 0.371 mi.
		101.030	AH Equation
		101.111	ECL Mountain View
		105.124	Little Dry Cr. [CWT;SS]
		105.588	Leavitt Draw [CWU;SS]
		109.052	Cottonwood Cr. [LVG;SS]
		120.610	Henry's Fork Rv. [CWW;SS]
		121.810	Lonetree
		123.500	Beaver Cr. [CWX;SS]
7	127.696	Sweetwater Co. Line	

→ -cont- In Sweetwater Co.

Maint. Section	class	RM	I-80 SV. RD.
			ML - 2108B
UI 01M 3042	9	0.000	I-80 Sv. Rd. Sep.(RM 56.72)
		0.270	ML 1922

Maint. Section	class	RM	I-80 SV. RD.
			ML - 1922B
UI 01U 3042	9	4.550	From Sweetwater County Line
		8.420	I-80 (RM 53.31);Church Buttes Int.

Maint. Section	class	RM	I-80 SV. RD.
			ML - 2110B
UI 01N 3042	9	0.000	I-80 (RM 41.99);Lyman Int.
		2.000	End Sv. Rd. @Cattleguard

Maint. Section	class	RM	I-80 SV. RD.
			ML - 2111B
UI 01L 3036	19	0.000	US 189 BUS (RM 6.43)
		0.450	CL Evanston
		0.600	UL Evanston
	9	1.600	End Sv. Rd. Highway Patrol Pistol Range

Maint. Section	class	RM	I-80 SV. RD.
			ML - 2112B
UI 13Z 3036	16	0.000	US 189 BUS (RM 3.68)
		1.060	CL Evanston
		1.350	UL Evanston
	9	1.590	Bridge
	3.520	End Sv. Rd. @Utah State Line	

Maint. Section	class	RM	I-80 SV. RD.
			ML - 2113B
UI 01T 3036	9	0.000	I-80 (RM 10.68);@Painter Int.
		1.130	End SHS @County RD.
			I-80 (RM 11.80)

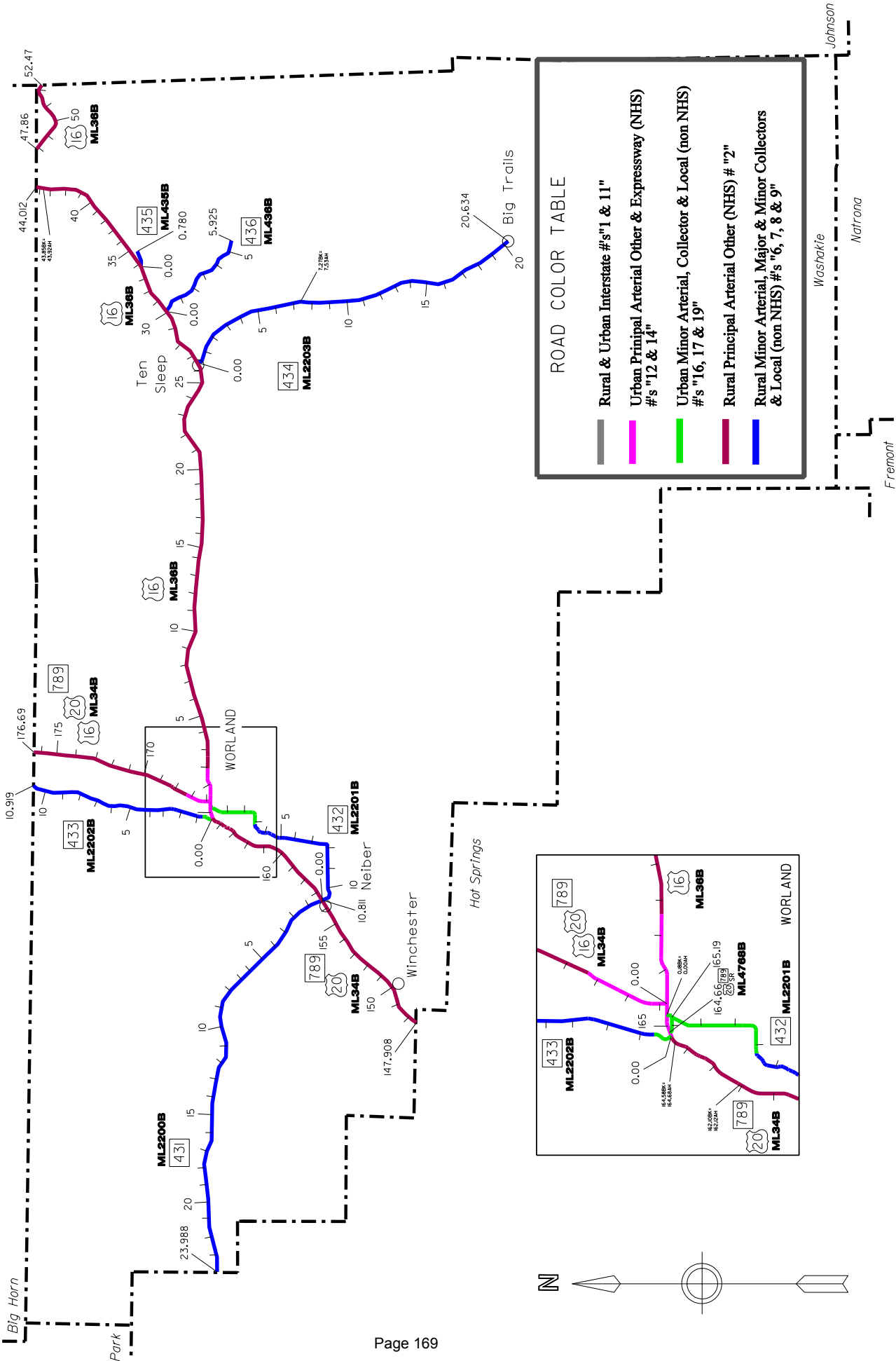

ROAD COLOR TABLE

- Rural & Urban Interstate #s "1 & 11"
- Urban Principal Arterial Other & Expressway (NHS) #s "12 & 14"
- Urban Minor Arterial, Collector & Local (non NHS) #s "16, 17 & 19"
- Rural Principal Arterial Other (NHS) # "2"
- Rural Minor Arterial, Major & Minor Collectors & Local (non NHS) #s "6, 7, 8 & 9"

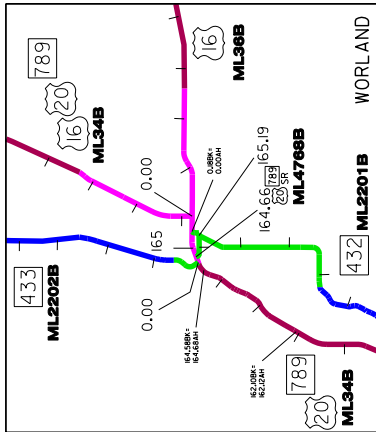

Washakie

County 20

— class "classification break"

+ Indicates Non State System

Maint. Section	class	RM	US 16/20 & WY 789
ML - 34B			
	2	147.908	Hot Springs Co. Line Cont. NHS
WA 01A		148.640	Chatham Rd
5041		150.346	Cottonwood Cr. [CCJ;SS]
		156.532	Gooseberry Cr. [CCK;SS]
		156.641	WY 431 (RM 0.00) & WY 432 (RM 10.81)
		160.082	WY Industrial Institute
		162.104	BK= - 0.018 mi.
		162.122	AH Equation
	2	163.862	Big Horn Canal [LVK;SS]
	—	163.890	WUL Worland
	14	164.338	Fifteen Mile Cr. [LVL;SS]
		164.584	BK= - 0.091 mi.
		164.675	AH Equation
		164.717	WY 433 (RM 0.00) W. River Rd
	—	164.798	WCL Worland
		165.003	Big Horn Rv. [CCN;SS]
WA 01Z		165.360	RR at Grade Crossing #090867N
5041		165.379	WY 432 (RM 0.00) Railroad Ave
		165.703	US 16 (RM 0.00) Begin US 16
	14	166.593	NCL Worland
	—	167.220	NUL Worland
WA 01B	2	168.822	Slick Cr. [FDF;SS]
5041		171.000	Unnamed Draw [KMR;SS]
	2	176.691	Big Horn Co. Line Cont. NHS

US 16			
ML - 36B			
	14	0.000	US 20, WY 789 (RM 165.70)
WA 02Z		0.270	Begin Divided Section
5041		0.313	Lower Hanover Canal [CDS;SS]
		0.360	15th St
	14	1.580	ECL Worland
	—	1.940	EUL Worland
WA 02A	2	2.590	County Rd (north)
5041		2.638	Slick Cr. [LYY;SS]
		4.568	Old Tensleep Highway
	—	6.580	Maint. Break
		10.290	Old Tensleep Highway
WA 02B		17.210	Cottonwood Cr. [CDU;SS]
5039		18.190	Old Tensleep Highway
		25.758	Nowood Rv. [CDV;SS]
		25.890	Lower Nowood Rd
		26.357	WCL Ten Sleep
	2	26.421	WY 434 (RM 0.00)

→ -cont- next column

Maint. Section	class	RM	US 16
ML - 36B			
<i>(CONTINUED)</i>			
	2	26.762	ECL Ten Sleep
		28.010	Dept. Shop - Tensleep TS 05A
		28.908	Ten Sleep Cr. [CDW;SS]
WA 02B		29.648	Ten Sleep Branch Cr. [CDX;SS]
5039		30.038	WY 436 (RM 0.00)
		30.697	Canyon Cr. [CDY;SS]
		32.573	Ten Sleep Cr. [CDZ;SS]
		33.899	WY 435 (RM 0.00)
		34.000	E.B. Road Close Gate R/R
		34.084	Big Horn Nat'l. Forest Boundary
		39.810	WB Truck Run-away Ramp
		41.758	Ten Sleep Cr. [FRY;SS]
		42.905	East Ten Sleep Cr. [CEB;SS]
		43.849	BK= - 0.073 mi.
		43.922	AH Equation
	—	44.012	Big Horn Co. Line / District Boundary
		47.860	Big Horn Co. Line
JO 04A		49.410	E.B. Road Close Gate R/R
4037	2	52.470	Johnson Co. Line
			→ -cont- in Johnson Co.

WY 431			
ML - 2200B			
WA 03A	7	0.000	US 20, WY 789 (RM 156.641) & WY 432 (RM 10.81)
5041		7.210	Homestead Ln.
	—	10.000	Maint. Break
WA 03B		23.238	Badlands Look out
5036	7	23.988	Hot Springs Co. Line

WY 432			
ML - 2201B			
		+ 0.000	US 20 (RM 165.379)
		+ 0.180	ML 4768 (RM 165.19)
	16	0.700	SCL Worland
WA 04A			End City / Begin state
5041		1.480	Lower Hanover Canal [EWV;SS]
	16	2.590	Airport Rd
	—	3.470	SUL Worland
	7	3.988	BK= + 0.179 mi.
		3.809	AH Equation
			Nowater Cr. [CXA;SS]
		4.790	County Rd (west)
		6.523	Upper Hanover Canal [CXB;SS]
		8.400	Upper Hanover Canal [CXC;SS]
		10.367	Big Horn Rv. [CXD;SS]
		10.730	RR at Grade Crossing #090494S
	7	10.811	US 20, WY 789 (RM 156.641) & WY 431 (RM 0.00)

Maint.		WY 433	
Section	class	RM	
ML - 2202B			
CREW			
	16	0.006	US 20, WY 789 (RM 164.717)
WA 05Z		0.184	Big Horn Canal [LVQ;SS]
5041		0.250	Dept. Shop - Worland WL 05A
	16	0.542	SCL Worland
		0.623	NCL & NUL Worland
	7		End Curb & Gutter
WA 05A		2.668	Dry Draw [CGV;SS]
5041		4.439	Big Horn Canal [CXF;SS]
		4.628	Ten Mile Cr. [CXG;SS]
		4.889	Big Horn Canal [CXH;SS]
		5.900	Lane 6A
		7.148	Dry Draw [CXI;SS]
		7.991	Big Horn Canal [KDR;SS]
	7	10.919	Big Horn Co. Line

Maint.		WY 434	
Section	class	RM	
ML - 2203B			
CREW			
	7	0.000	US 16 (RM 26.42)
		0.189	SCL Ten Sleep
WA 06A		0.280	Ten Sleep Cr. [DJP;SS]
5039		7.274	BK= - 0.258 mi.
		7.532	AH Equation
			Spring Cr Rd
		12.059	Otter Cr. [CXL;SS]
		20.634	End SHS @Big Trails

Maint.		WY 435	
Section	class	RM	
ML - 435B			
CREW			
WA 07A	9	0.000	US 16 (RM 33.90)
5039		0.780	End SHS
	+	0.950	Tensleep Cr [CYG;SS]
		1.170	Old US 16/Fish Hatchery Road

Maint.		WY 436	
Section	class	RM	
ML - 436B			
CREW			
WA 09A	8	0.000	US 16 (RM 30.04)
5039		2.520	WYDOT Pit
		5.925	End SHS

Maint.		US 20 SV. RD.	
Section	class	RM	
ML - 4768B			
CREW			
	17	164.660	US 20, WY 789 (RM 164.84)
WA 01X		164.870	Big Horn River Bridge [EOJ;SS]
5041		164.940	WCL Worland
		165.190	End Sv. Rd. @begin City St.

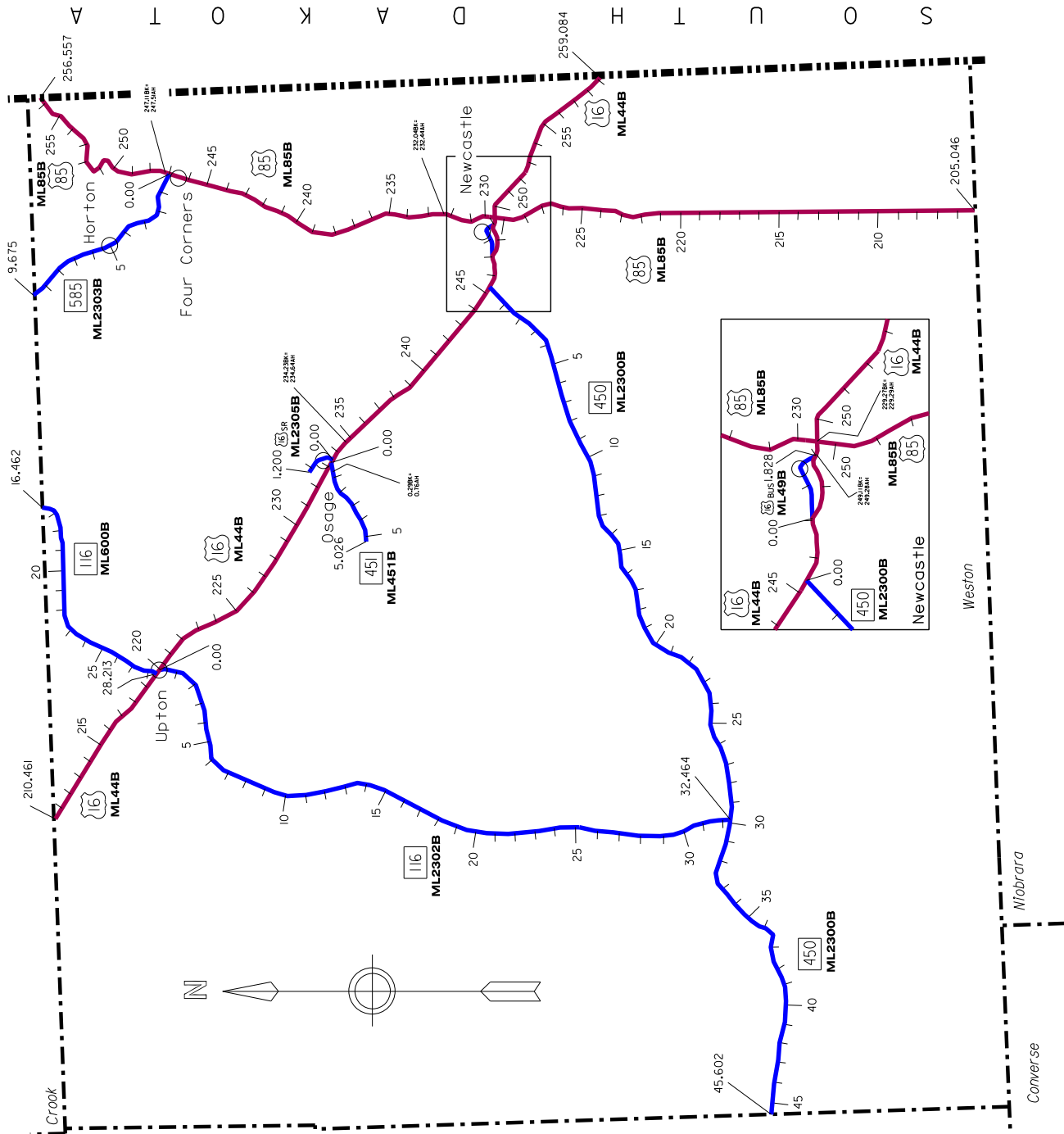

ROAD COLOR TABLE	
	Rural & Urban Interstate #'s "1 & 11"
	Urban Prinsipal Arterial Other & Expressway (NHS) #'s "12 & 14"
	Urban Minor Arterial, Collector & Local (non NHS) #'s "16, 17 & 19"
	Rural Principal Arterial Other (NHS) # "2"
	Rural Minor Arterial, Major & Minor Collectors & Local (non NHS) #'s "6, 7, 8 & 9"

S O U T H W E S T A T A

Weston

class "classification break"

County 21

Maint. Section	class	RM	US 16
CREW		ML - 44B	
WE 02A	2	210.461	Crook Co. Line Cont. NHS
4040		212.429	E. Branch Wind Cr. [CHN;SS]
		213.260	Thornton
		219.245	WCL Upton
		219.827	WY 116 (RM 28.21) north
		220.131	WY 116 (RM 0.00) south
WE 02B	2		Cont. NHS
4041		220.501	ECL Upton
		220.800	Upton Rest Area WE 02R
		222.364	BNRR Sep. (Under) [CHO;SS]
		226.314	Pine Cr. [CHP;SS]
		228.881	Turner Cr. [CHQ;SS]
		233.293	WY 451 (RM 0.00)
		234.234	BK= - 0.402 mi.
		234.636	AH Equation
		239.161	Skull Cr. [CHR;SS]
		241.380	Airport Rd
		242.924	Oil Cr. [CHS;SS]
		245.087	Alum Cr. [CHT;SS]
		245.600	W.B. Road Closed Gate R/R
		245.668	WY 450 (RM 0.00)
		247.322	WCL Newcastle
		247.343	US 16 (RM 0.00) CL Newcastle, End US 16 / Begin US 16 Bypass
			Newcastle Port-of-Entry WE 02P
		247.677	Cambria Cr. [DBI;SS]
		248.220	Stampede St
		248.275	CL Newcastle
		248.696	BNRR Sep. (Under) [DBJ;SS]
		248.820	Dept. Shop - Newcastle NC 04A
		248.991	US 16 (RM 1.83) End US 16 Bypass / Begin US 16
		249.108	BK= - 0.174 mi.
		249.282	AH Equation
		249.664	ECL Newcastle
		249.816	US 85 (RM 229.27)
		251.820	Salt Cr Rd
		252.829	Salt Cr. [CHV;SS]
		254.000	E.B. Road Closed Gate R/R
		254.335	Stockade Beaver Cr. [CHW;SS]
		254.620	Grievs/Fisher Rd
		258.686	Whoopup Cr. [CHX;SS]
	2	259.084	South Dakota State Line End WY NHS

Maint. Section	class	RM	US 16
CREW		ML - 49B	
WE 09Z	6	0.000	US 16 (RM 247.34)
4041		0.583	Cambria Cr. [CHU;SS]
		1.090	RR at Grade Crossing #064920E
		1.450	Old Highway CL Newcastle
		1.828	US 16 (RM 248.99)
			US 85
		ML - 85B	
WE 01A	2	205.062	Niobrara Co. Line Cont. NHS
4041		208.610	Sheep Cr.
		211.939	Beaver Cr. [JBJ;SS]
		222.410	W. Branch Blacktail Cr.
		223.100	Blacktail Cr.
		226.040	Old Highway
		228.993	BNRR Sep. (Under) [BXJ;SS]
		228.980	SCL Newcastle
		229.000	S.B. Road Closed Gate R/R
		229.060	NCL Newcastle
		229.271	US 16 (RM 249.82) BK= - 0.019 mi.
		229.290	AH Equation
		230.100	Musser Rd
		232.040	BK= - 0.396 mi.
		232.436	AH Equation
		233.290	N.B. Road Closed Gate R/R
		238.047	BK= -0.053 mi (NEW)
		238.100	AH Equation
		240.554	Red Butte Cr.
		247.112	BK= - 0.396 mi.
		247.508	AH Equation
		247.300	WY 585 (RM 0.00); Four Corners N.B. Road Closed Gate R/R
		250.950	Buckhorn
		253.529	Black Hills Nat'l. Forest Boundary
		253.933	Black Hills Nat'l. Forest Boundary
	2	256.557	South Dakota State Line End WY NHS

Maint. Section	class	RM	WY 116 (NORTH)
			ML - 600B
WE 04A	7	16.462	Crook Co. Line
4041		16.710	Mason Cr. [FQB;SS]
		17.574	Mason Cr. [FPZ;SS]
		17.880	Mason Cr Stockpass [FQA;SS]
		18.207	Mason Cr. [FPY;SS]
		19.064	Sage Cr.
		22.363	Dry Draw
		26.305	Unnamed Draw
		27.500	N.B. Road Closed Gate R/R
		27.638	CL Upton
		28.213	US 16 (RM 219.827)

Maint. Section	class	RM	WY 451
			ML - 451B
WE 06A	8	0.000	US 16 (RM 233.29)
4041		4.392	Beaver Cr. [FLB;SS]
		5.026	End SHS
			WY 585
			ML - 2303B
WE 03A	6	0.000	US 85 (RM 247.603)
4041			Four Corners Jct.
		9.675	Crook Co. Line

Maint. Section	class	RM	WY 116 (SOUTH)
			ML - 2302B
WE 07A	7	0.000	US 16 (RM 220.131)
4041		0.205	BNRR Sep. (Under) [DGD;SS]
		0.328	SCL Upton
		0.600	S.B. Road Closed Gate R/R
		0.715	Iron Cr. [FQC;SS]
		1.647	Coyote Cr. [FQD;SS]
		2.642	Beaver Cr. [FQE;SS]
		3.270	Lone Tree Cr.
		6.525	North Fork Soda Cr. [FQF;SS]
		7.183	South Fork Soda Cr. [FQG;SS]
		12.570	Unnamed Draw
		13.000	Unnamed Draw
		13.150	Buffalo Cr.
		20.270	W. Fork Hay Cr. [LUS;SS]
		25.764	Lodgepole Cr. [DDN;SS]
		32.460	W.B. Road Closed Gate swing
		32.464	WY 450 (RM 29.81)

Maint. Section	class	RM	US 16 SV. RD. Rd. to Osage
			ML - 2305B
WE 02X	8	0.000	US 16 (RM 233.49)
4041		0.750	Class Break
	9	1.200	End Sv. Rd. at 0.09 mi. N. of Apostol Ave.

Maint. Section	class	RM	WY 450
			ML - 2300B
WE 05A	6	0.000	US 16 (RM 245.67)
4041		0.300	W.B. Road Closed Gate R/R
		1.963	Oil Cr. [FPA;SS]
		3.559	Skull Cr. [FLX;SS]
		6.932	Beaver Cr. [KPB;SS]
		9.695	Mush Cr. [FLW;SS]
		12.080	Seeley Rd (north)
		15.222	S. Beaver Cr. [KPC;SS]
		23.646	Lodgepole Cr. [KPD;SS]
		29.805	WY 116 (RM 32.46)
		29.885	Wildcat Cr. [LZD;MSS]
		36.314	Black Thunder Cr. [DFX;SS]
		45.602	Campbell Co. Line

INTERCHANGE

LAYOUTS

I-25

Terry Road Interchange

RM: 2.66

EXIT # 2

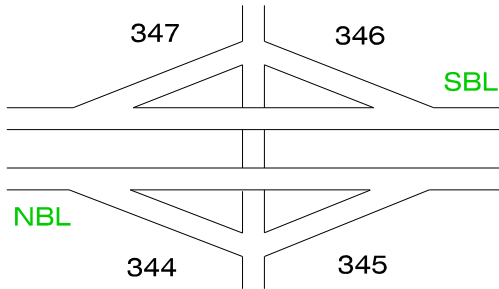

I-25 & I-80

Interchange

RM: 8.84

EXIT # 8

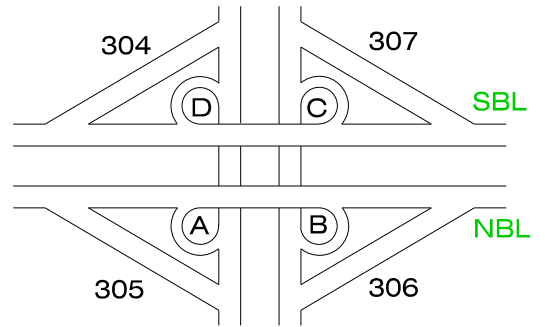

A=309 B=310 C=311 D=308

High Plains Interchange

RM: 4.85

EXIT # 4

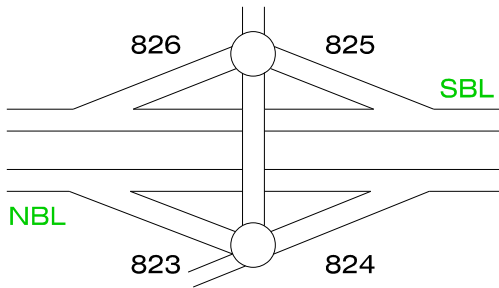

U.P.R.R. & U.S. 30 Interchange

RM: 9.14

EXIT # 9

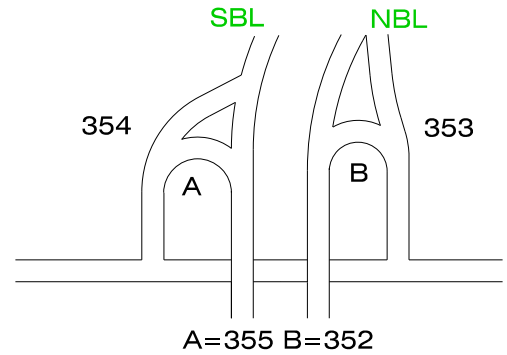

A=355 B=352

College Drive Interchange

RM: 7.85

EXIT # 7

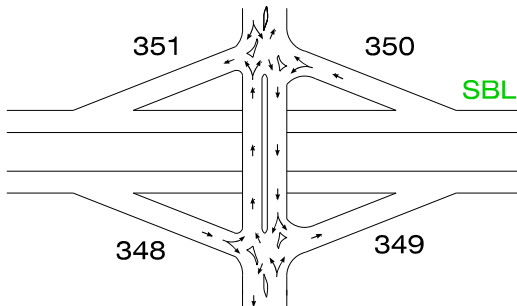

Missile Drive Interchange

RM: 10.59

EXIT # 10

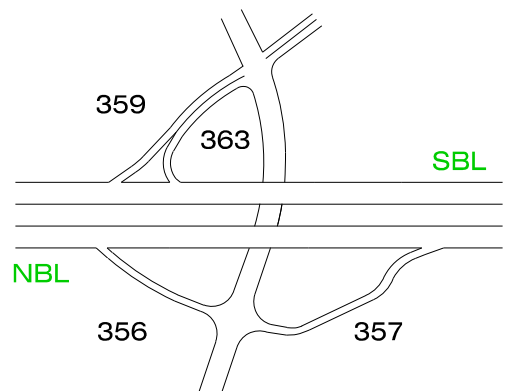

Randall Ave. Interchange

RM: 11.24 EXIT # 11

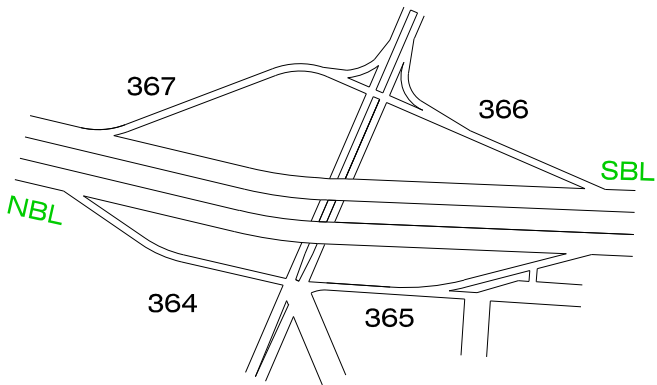

U.S.- 87 & 85 Interchange

RM: 17.24 EXIT # 17

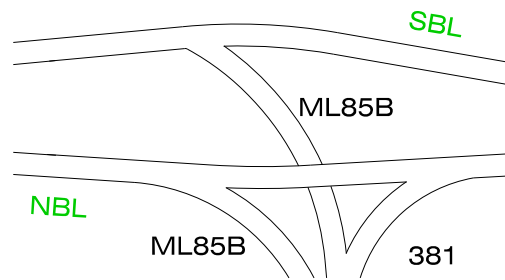

Central Ave. Interchange

RM: 12.70 EXIT # 12

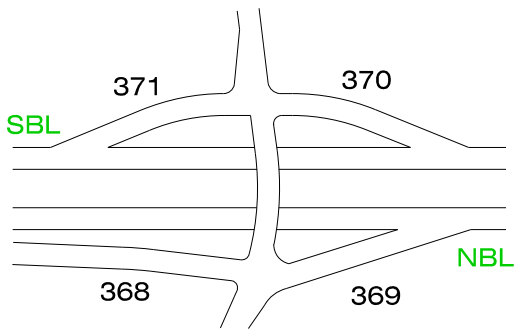

Ridley Road Interchange

RM: 21.32 EXIT # 21

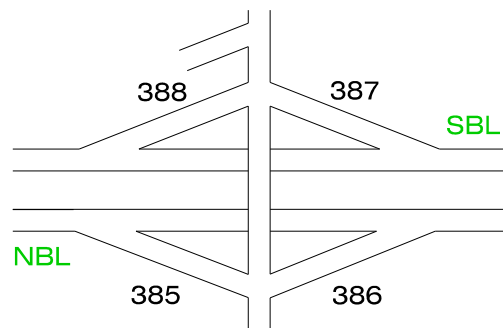

Vandehei Interchange

RM: 13.83 EXIT # 13

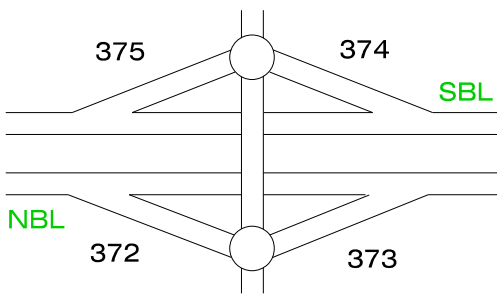

Missile Site "A" Interchange

RM: 25.45 EXIT # 25

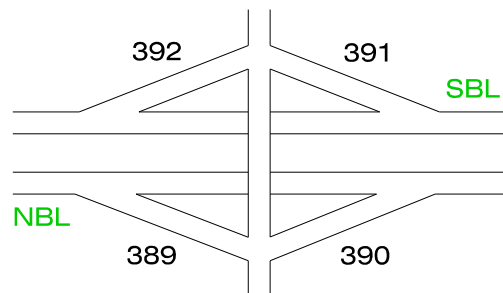

Iron Mtn. & US 85 N. Interchange

RM: 16.23 EXIT # 16

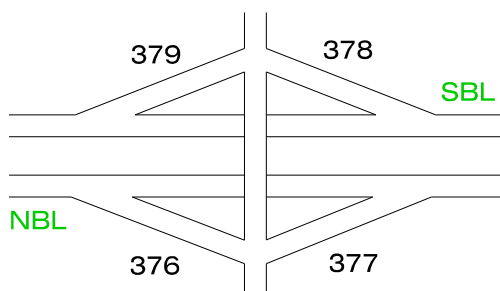

Whitaker Road Interchange

RM: 29.51 EXIT # 29

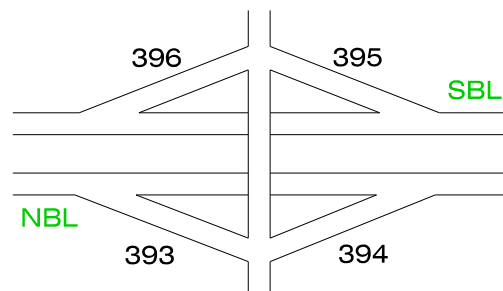

Nimmo Road Interchange

RM: 34.44

EXIT # 34

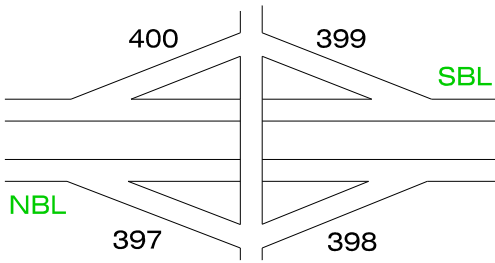

TY Basin Interchange

RM: 57.65

EXIT # 57

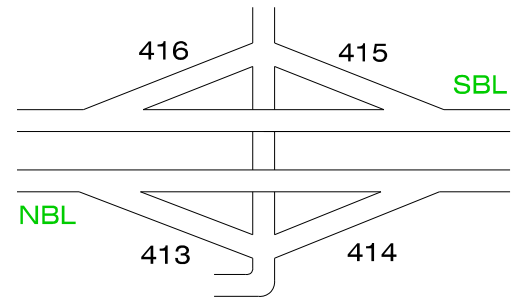

Indian Hills Interchange

RM: 39.24

EXIT # 39

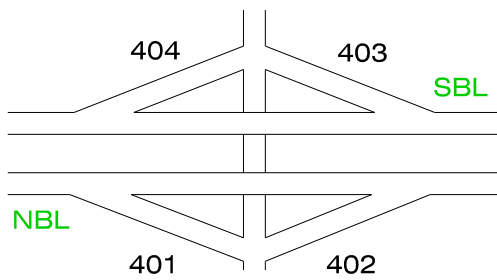

Slater Road Interchange

RM: 65.25

EXIT # 65

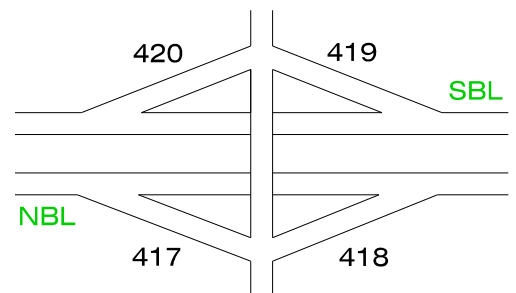

County Line Interchange

RM: 47.25

EXIT # 47

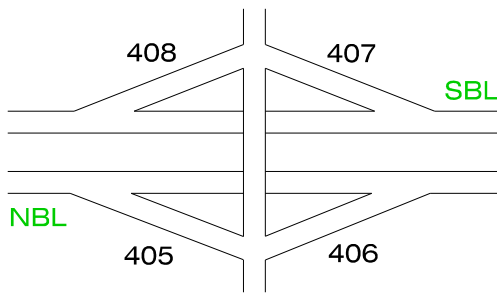

Hunton Interchange

RM: 66.20

EXIT # 66

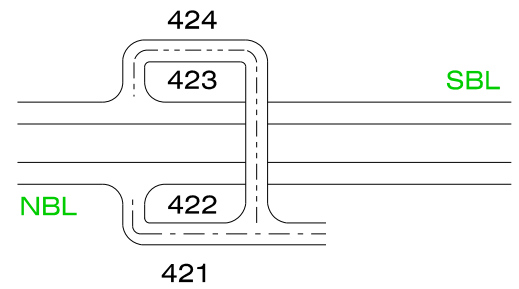

Chugwater Interchange

RM: 54.59

EXIT # 54

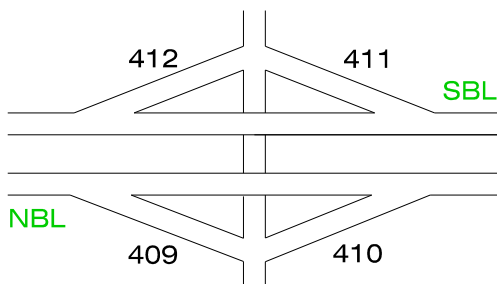

Antelope Interchange

RM: 68.45

EXIT # 68

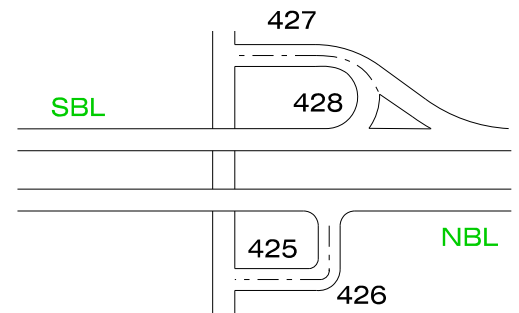

Bordeaux Interchange

RM: 70.62

EXIT # 70

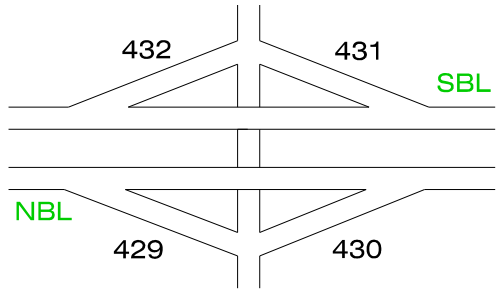

Laramie River Interchange

RM: 84.74

EXIT # 84

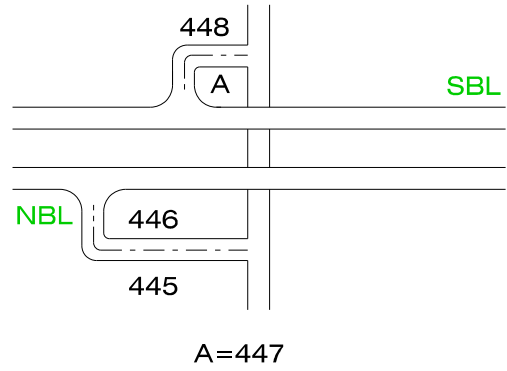

Wyoming 34 Interchange

RM: 73.03

EXIT # 73

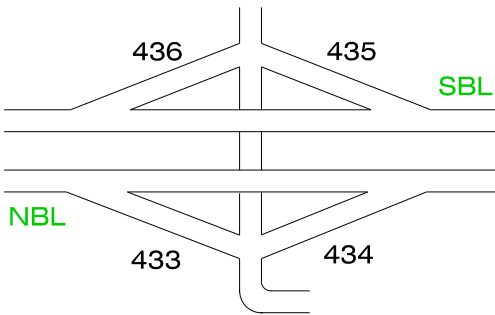

N. Laramie River Interchange

RM: 87.51

EXIT # 87

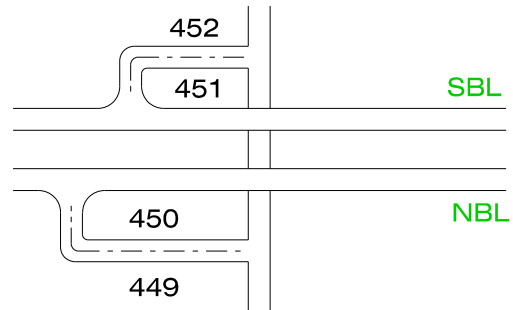

South Wheatland Interchange

RM: 78.93

EXIT # 78

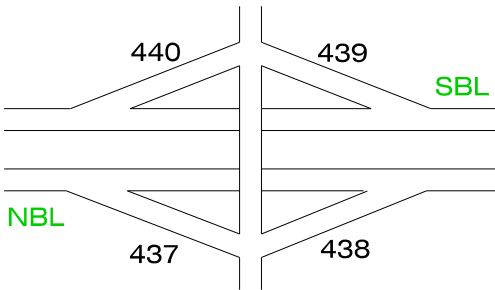

Dwyer Jct. Interchange

RM: 92.37

EXIT # 92

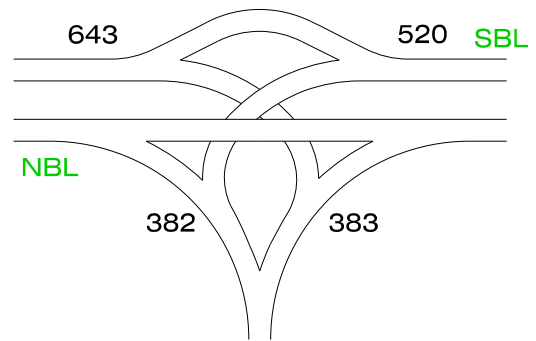

North Wheatland Interchange

RM: 80.85

EXIT # 80

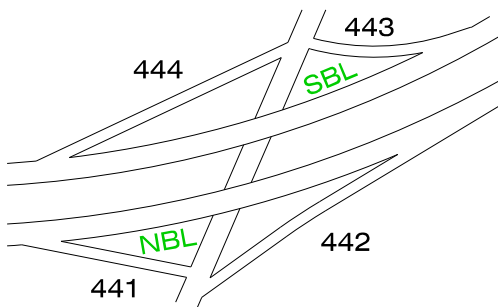

El Rancho Interchange

RM: 94.83

EXIT # 94

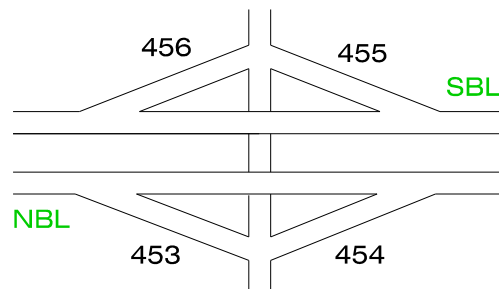

Cassa Interchange

RM: 100.13

EXIT # 100

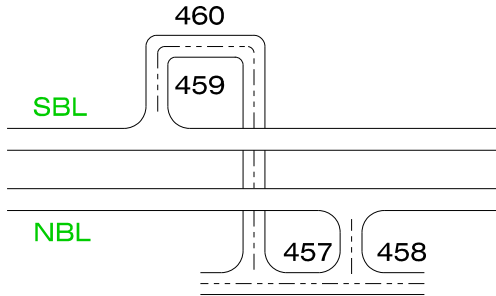

East Douglas Interchange

RM: 135.47

EXIT # 135

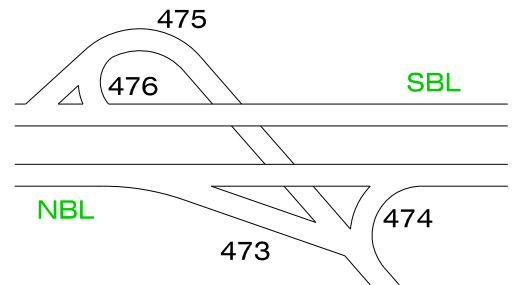

Middle Bear Interchange

RM: 104.04

EXIT # 104

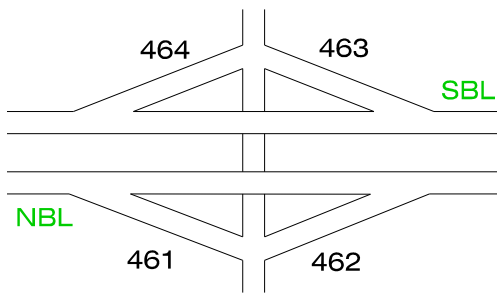

West Douglas Interchange

RM: 140.10

EXIT # 140

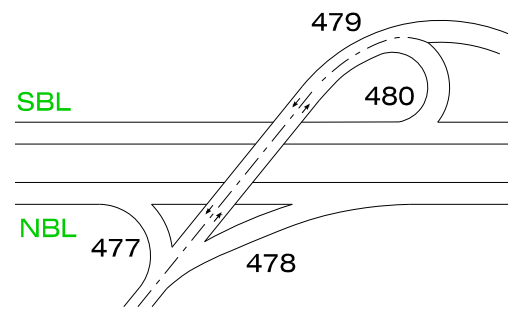

Glendo Interchange

RM: 111.68

EXIT # 111

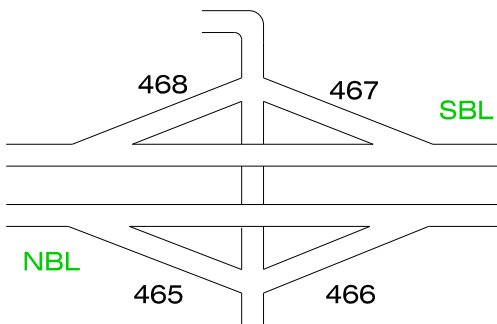

LaPrele Interchange

RM: 146.00

EXIT # 146

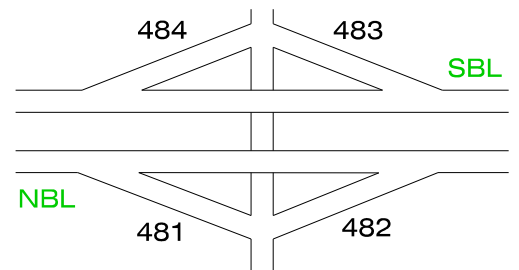

Orin Junction Interchange

RM: 126.47

EXIT # 126

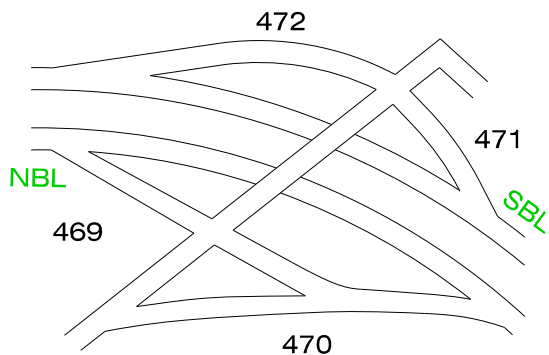

Inez Interchange

RM: 150.44

EXIT # 150

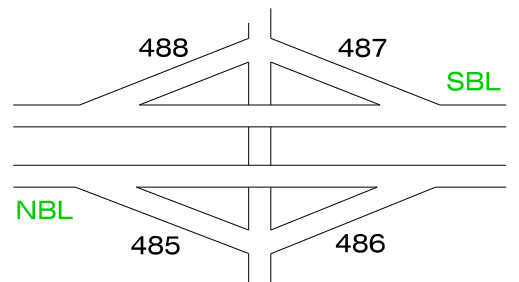

Natural Bridge Interchange

RM: 151.17

EXIT # 151

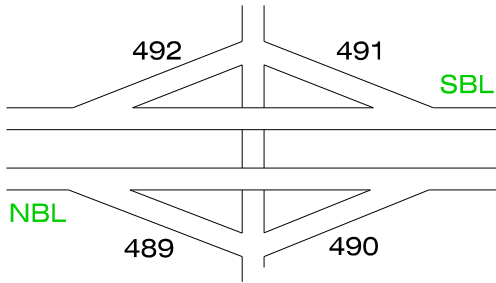

Deer Creek Interchange

RM: 165.91

EXIT # 165

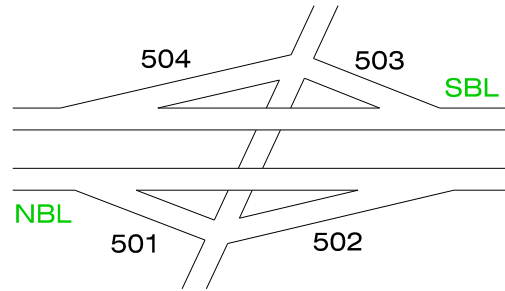

Barber Interchange

RM: 154.24

EXIT # 154

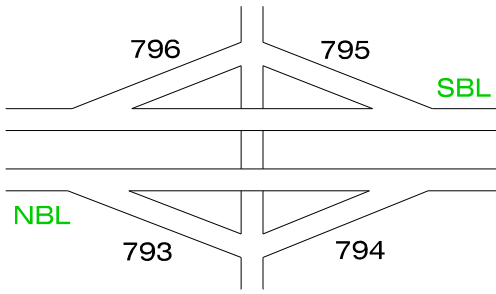

Hat Six Interchange

RM: 182.53

EXIT # 182

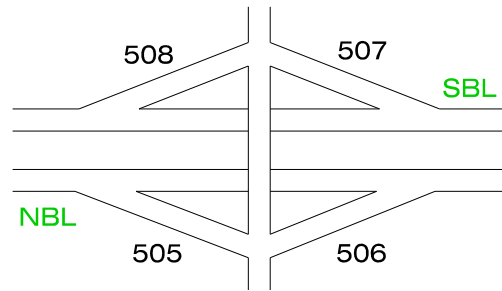

Bixby Interchange

RM: 156.18

EXIT # 156

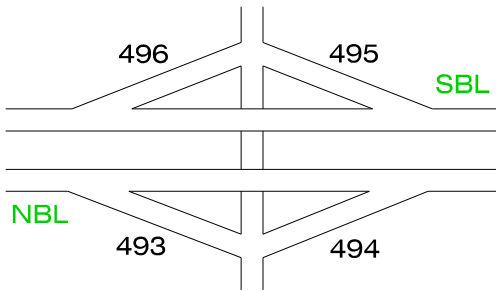

Evansville Interchange

RM: 185.35

EXIT # 185

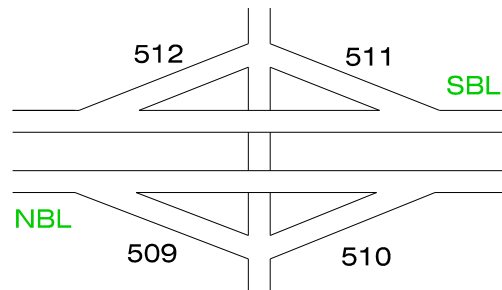

E. Glenrock Interchange

RM: 160.87

EXIT # 160

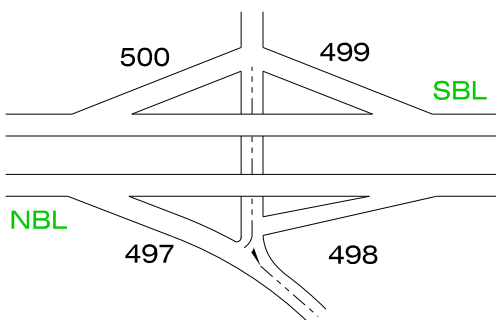

Yellowstone Street Interchange

RM: 186.36

EXIT # 186"A"

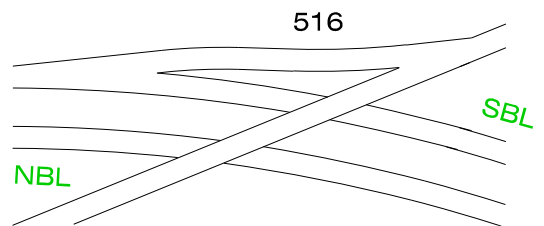

Bryan Stock Trail Interchange

RM: 186.79

EXIT # 186"B"

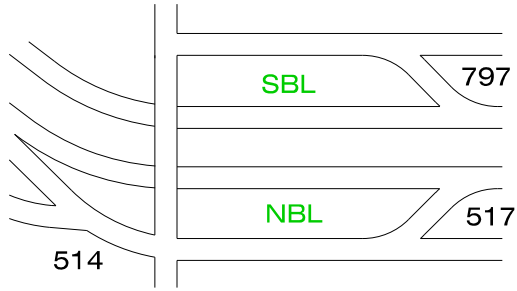

Shoshoni Interchange

RM: 189.51

EXIT # 189

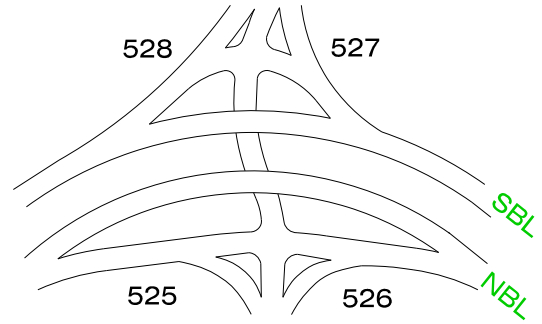

McKinley St. Interchange

RM: 187.53

EXIT # 187

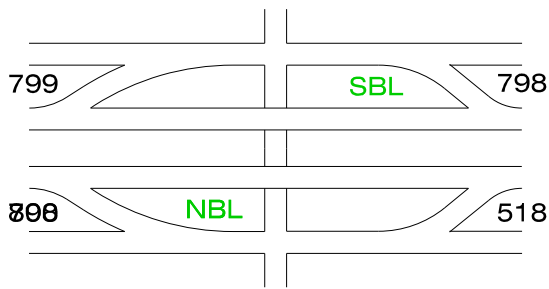

Wardwell Road Interchange

RM: 191.64

EXIT # 191

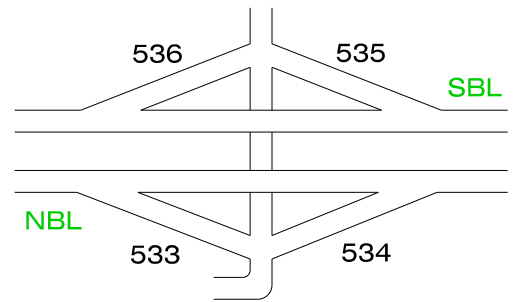

Center St. Interchange

RM: 188.19

EXIT # 188"A"

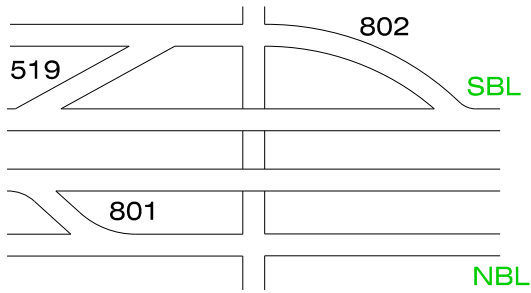

Ormsby Road Interchange

RM: 197.52

EXIT # 197

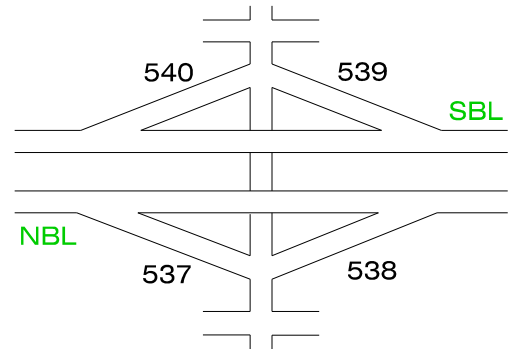

Poplar St. Interchange

RM: 188.60

EXIT # 188"B"

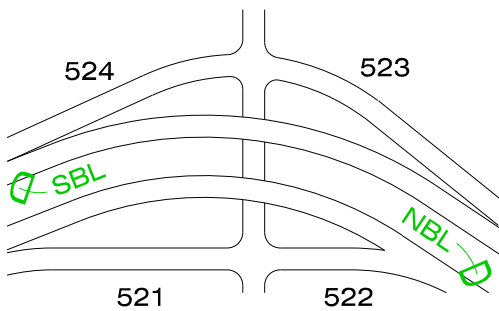

Horse Ranch Creek Interchange

RM: 210.41

EXIT # 210

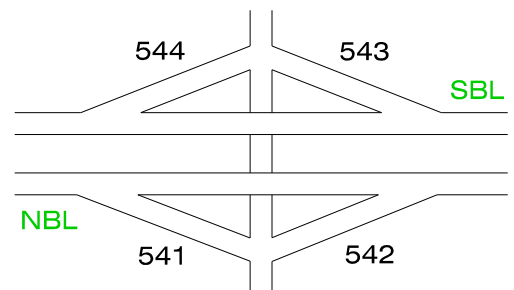

Ranch Road Interchange

RM: 216.43 EXIT # 216

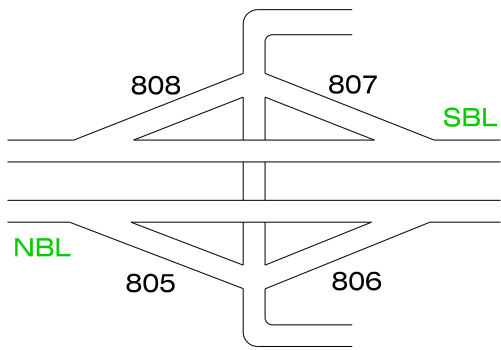

Powder River Interchange

RM: 246.56 EXIT # 246

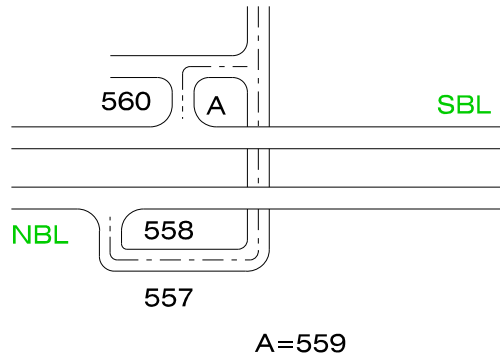

Midwest Interchange

RM: 223.78 EXIT # 223

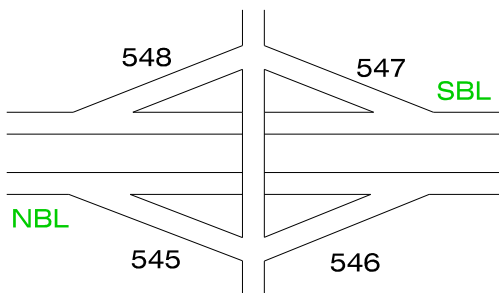

T. T. T. Interchange

RM: 249.69 EXIT # 249

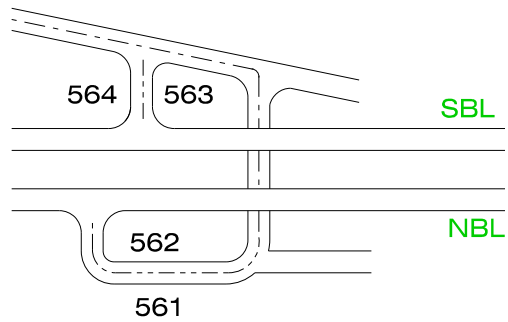

Smokey Gap Interchange

RM: 227.99 EXIT # 227

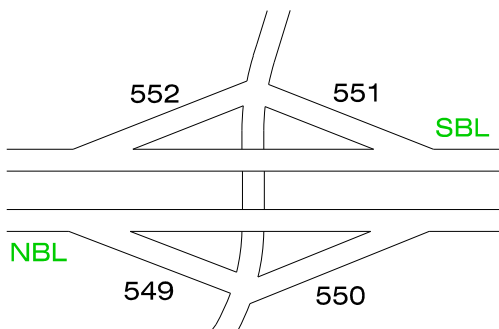

Kaycee Interchange

RM: 254.25 EXIT # 254

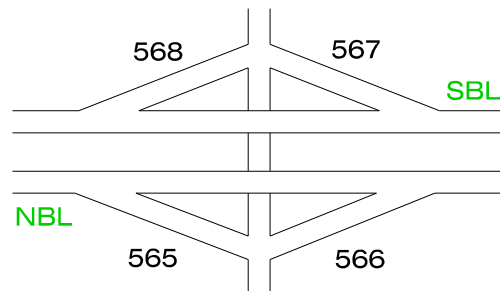

Tisdale Mtn. Road Interchange

RM: 235.38 EXIT # 235

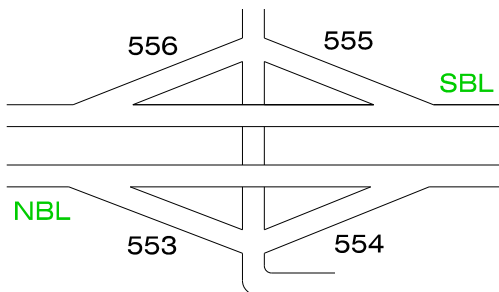

Reno Road Interchange

RM: 265.48 EXIT # 265

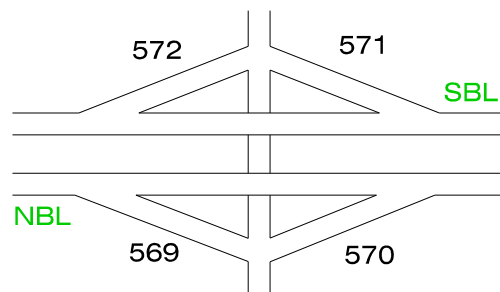

Middle Fork Road Interchange

RM: 280.18 EXIT # 280

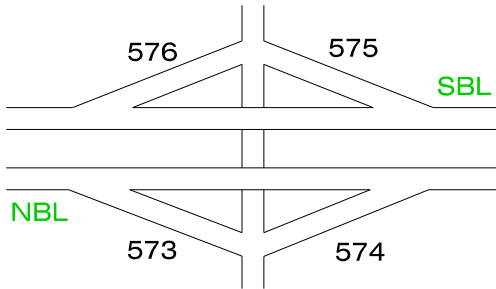

Buffalo Tri-Level Interchange

RM: 300.55 EXIT # 300

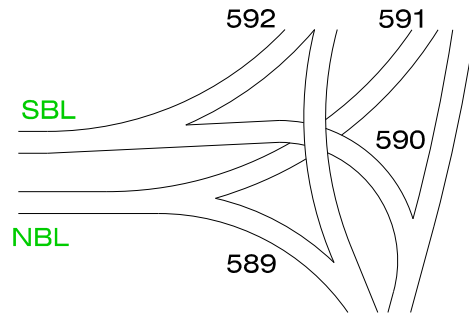

Trabing Road Interchange

RM: 291.08 EXIT # 291

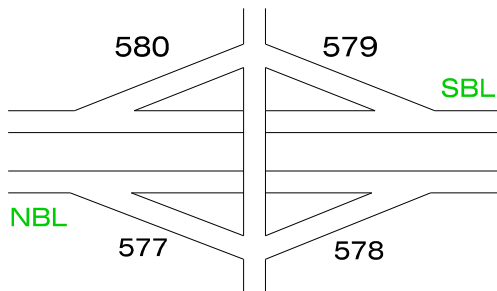

South Buffalo Interchange

RM: 298.02 EXIT # 298

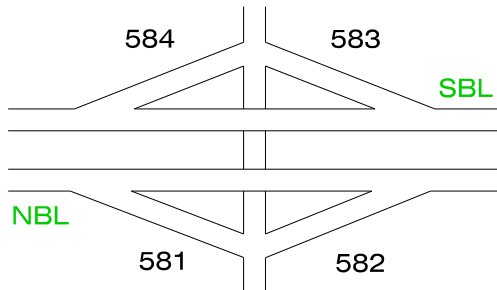

Buffalo-Ucross Interchange

RM: 299.32 EXIT # 299

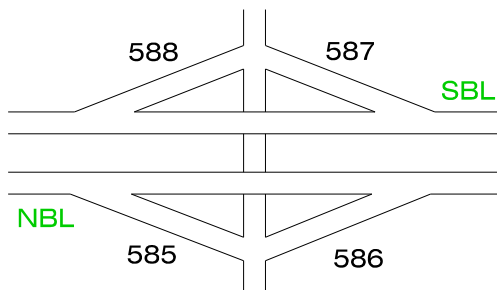

INTERCHANGE LAYOUT

I - 80

W. Evanston Interchange

RM: 3.45

EXIT # 3

Harrison Drive

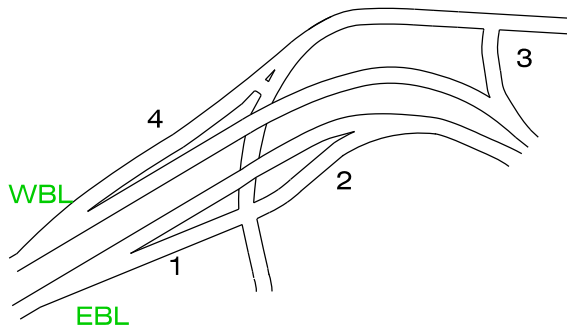

Painter Interchange

RM: 10.68

EXIT # 10

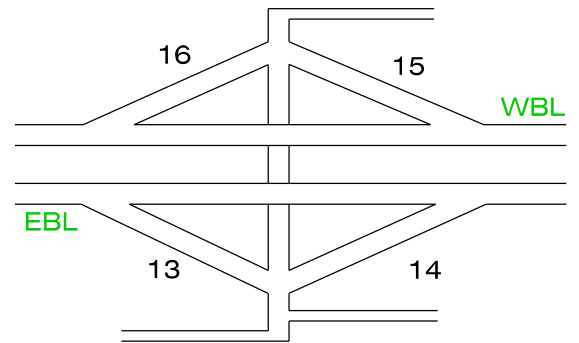

State Hospital Rd. Interchange

RM: 5.26

EXIT # 5

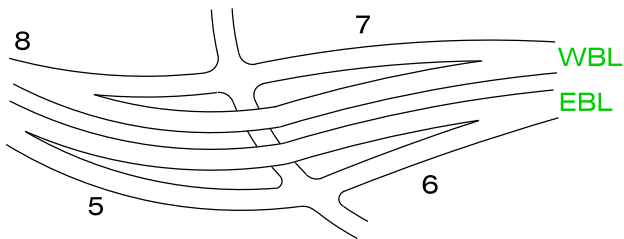

Divide Interchange

RM: 13.86

EXIT # 13

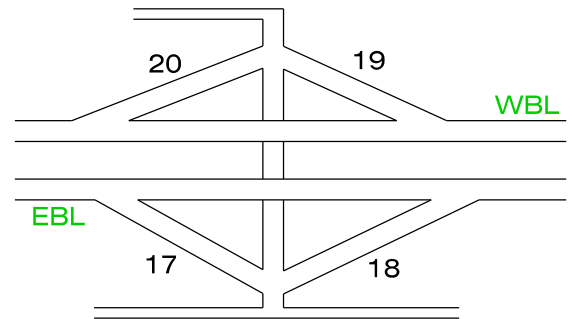

E. Evanston Interchange

RM: 6.26

EXIT # 6

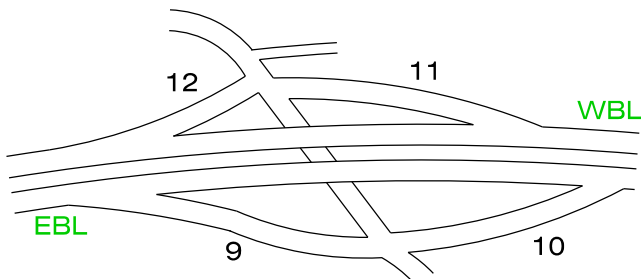

U.S.189 Interchange

RM: 18.29

EXIT # 18

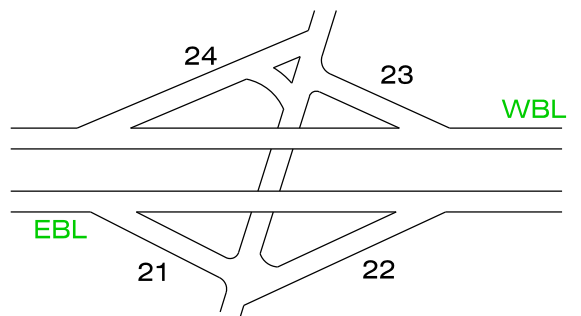

Coal Interchange
RM: 21.75

EXIT # 21

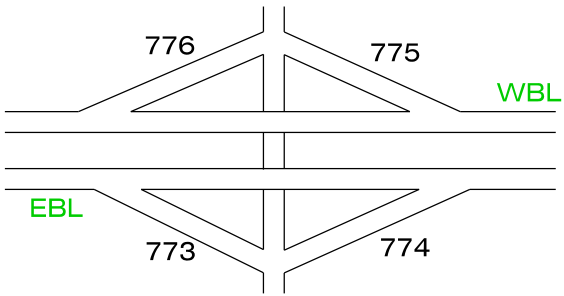

Bigelow Interchange
RM: 30.40

EXIT # 30

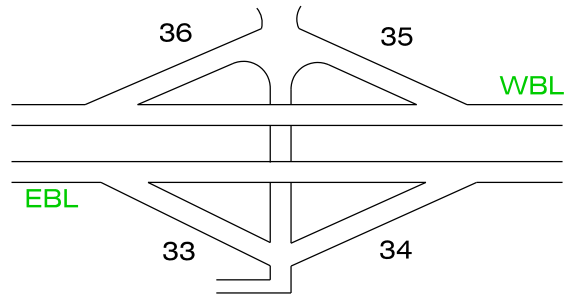

Bar Hat Interchange
RM: 23.12

EXIT # 23

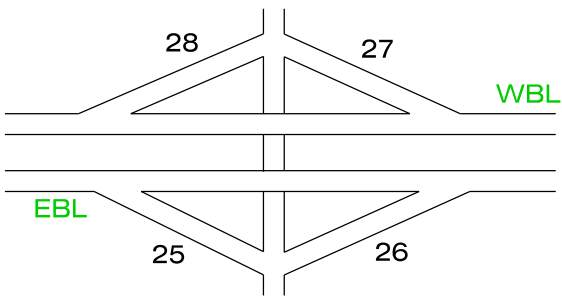

Union Interchange
RM: 33.18

EXIT # 33

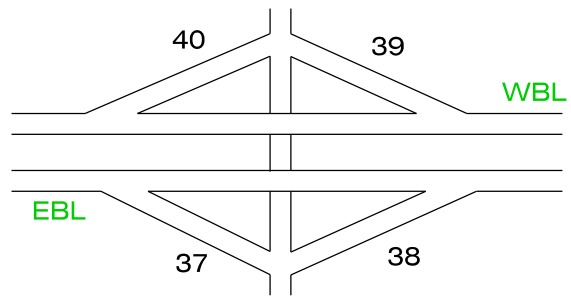

Leroy Interchange
RM: 23.91

EXIT # 24

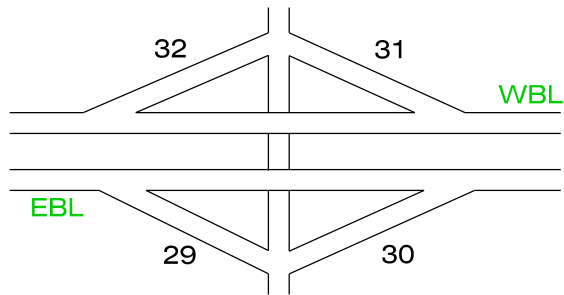

Fort Bridger Interchange
RM: 34.74

EXIT # 34

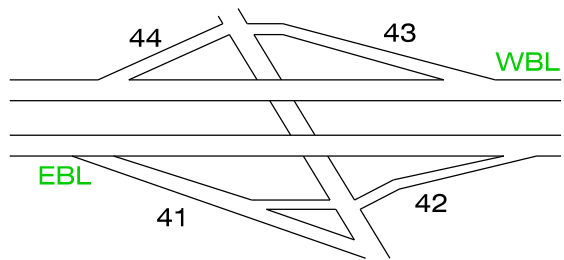

French Interchange
RM: 28.71

EXIT # 28

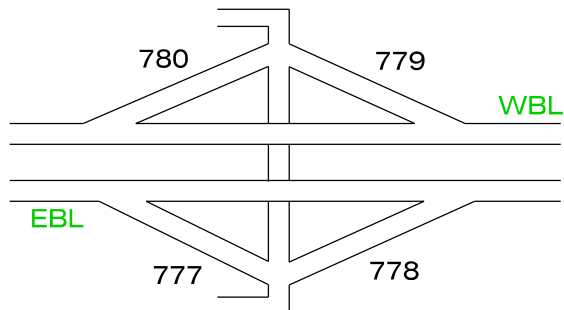

Carter-Mountainview Interchange
RM: 39.90

EXIT # 39

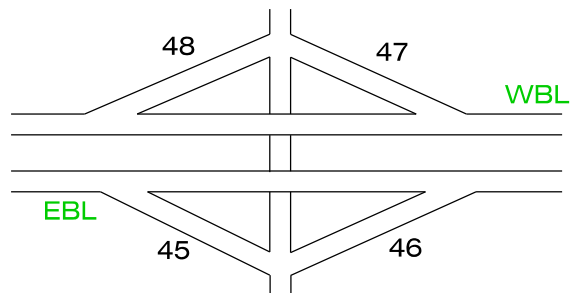

North Lyman Interchange
RM: 41.99 EXIT # 41

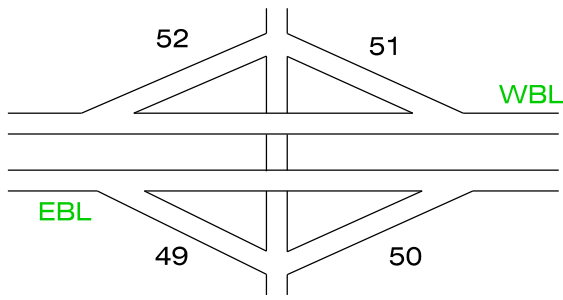

Granger Jct. Interchange
RM: 66.17 EXIT # 66

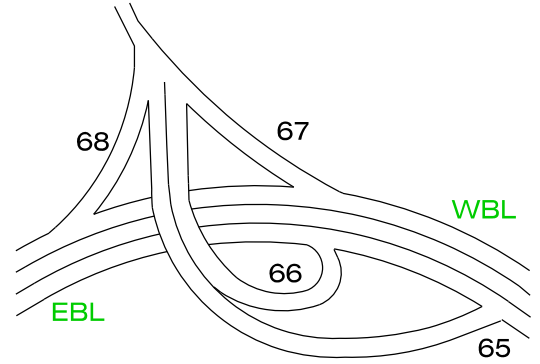

Bridger Valley Interchange
RM: 48.30 EXIT # 48

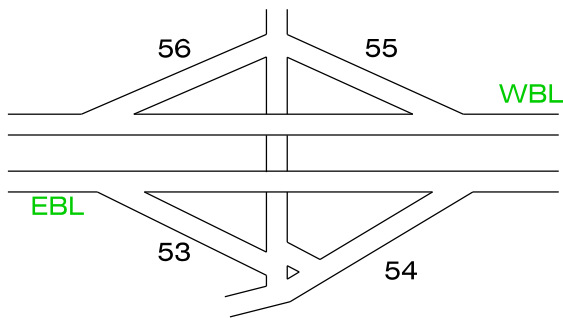

Little America Interchange
RM: 68.97 EXIT # 68

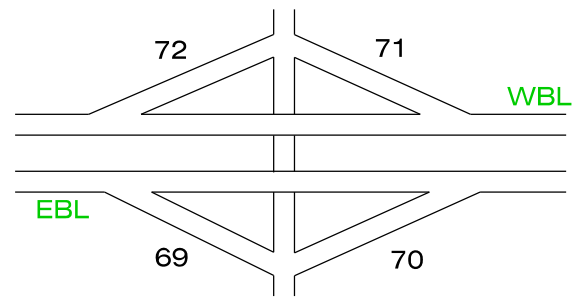

Church Buttes Interchange
RM: 53.31 EXIT # 53

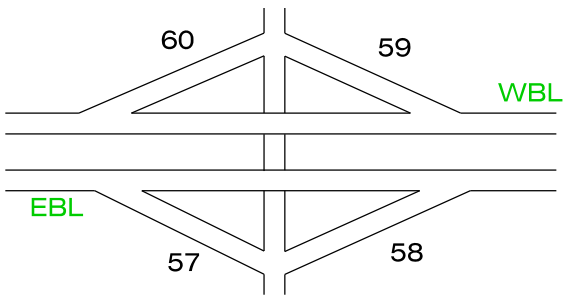

Westvaco Interchange
RM: 72.30 EXIT # 72

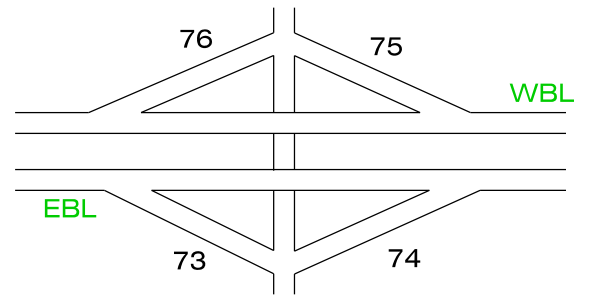

Cedar Mountain Road Interchange
RM: 61.59 EXIT # 61

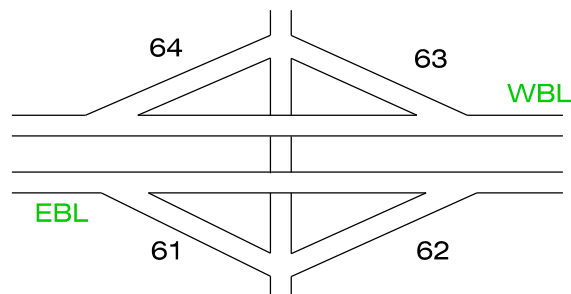

LaBarge Interchange
RM: 83.01 EXIT # 83

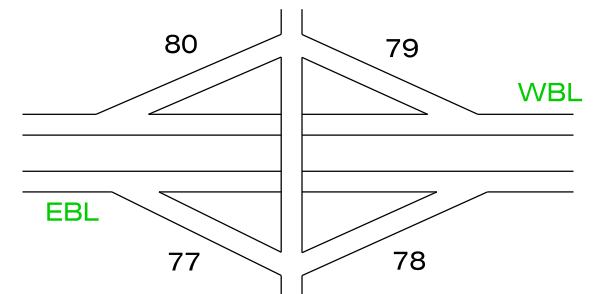

Covered Wagon Road Interchange

RM: 85.70

EXIT # 85

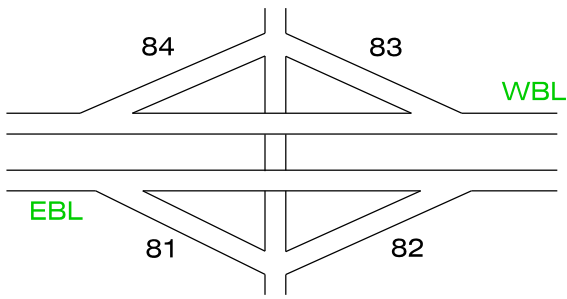

Dewar Drive Interchange

RM: 102.36

EXIT # 102

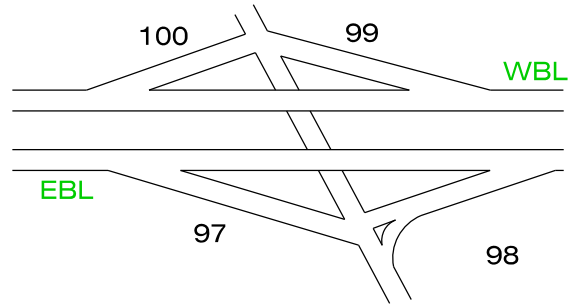

W. Green River Interchange

RM: 89.45

EXIT # 89

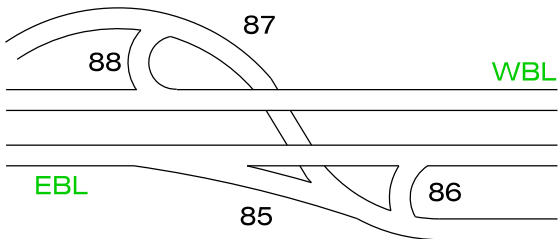

College Drive Interchange

RM: 103.82

EXIT # 103

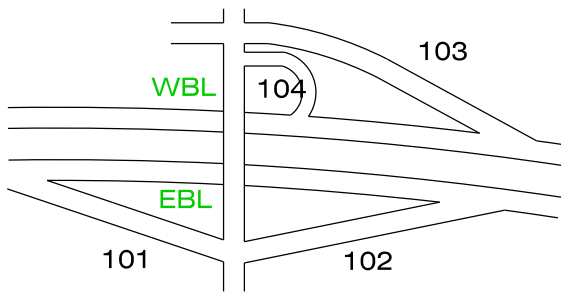

E. Green River Interchange

RM: 91.53

EXIT # 91

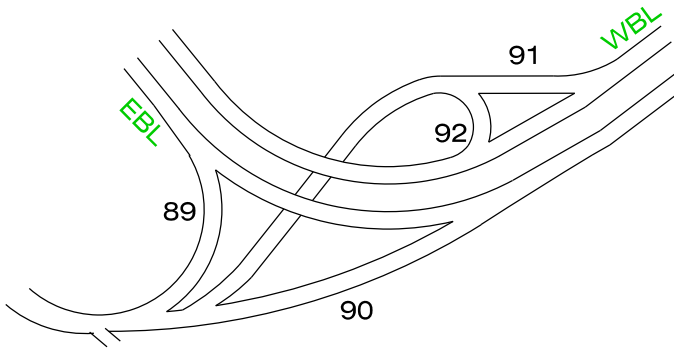

Elk Street Interchange

RM: 104.83

EXIT # 104

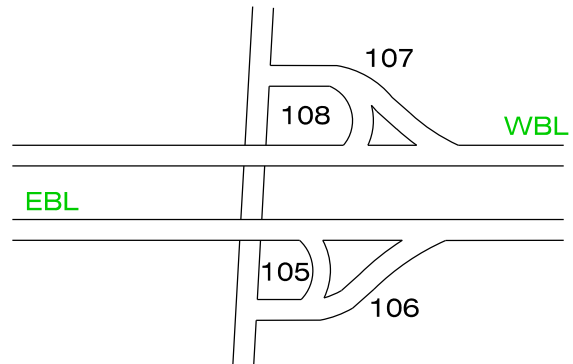

Flaming Gorge Interchange

RM: 99.14

EXIT # 99

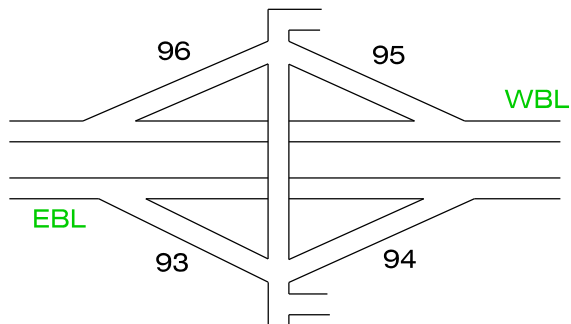

Pilot Butte Interchange

RM: 107.06

EXIT # 107

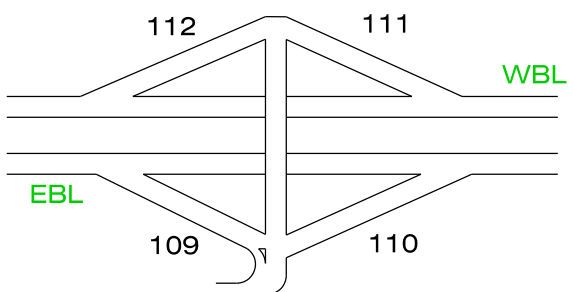

Baxter Road Interchange
RM: 111.16 EXIT # 111

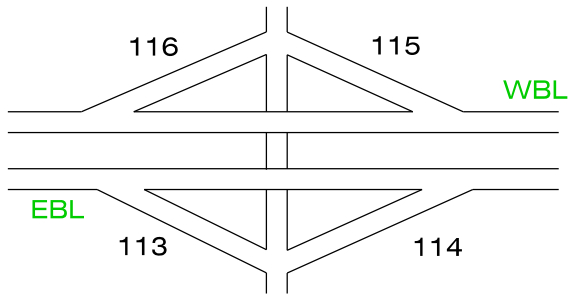

Red Hill Interchange
RM: 139.51 EXIT # 139

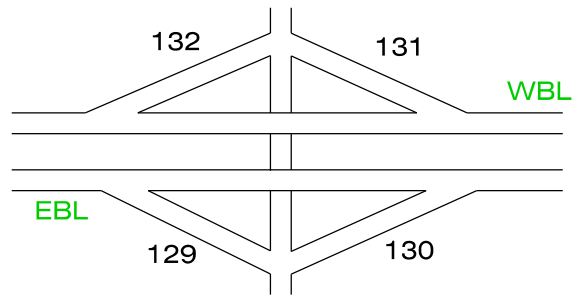

Superior Interchange
RM: 122.27 EXIT # 122

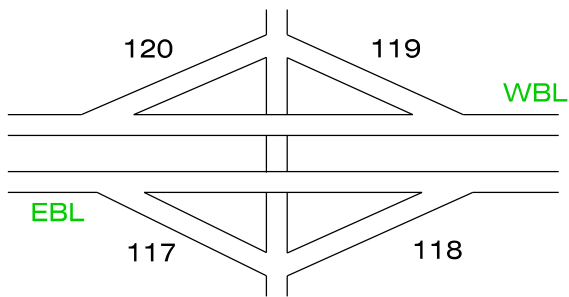

Bitter Creek Interchange
RM: 142.17 EXIT # 142

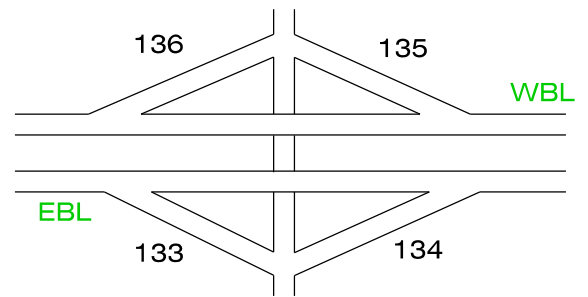

Point Of Rocks Interchange
RM: 130.84 EXIT # 130

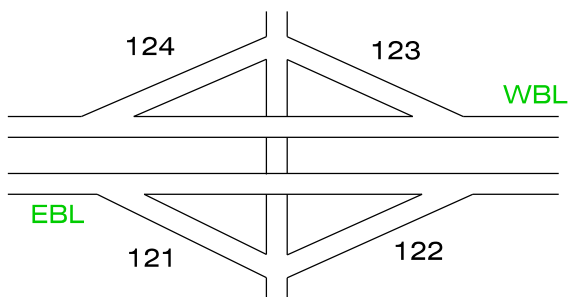

Patrick Draw Interchange
RM: 146.85 EXIT # 146

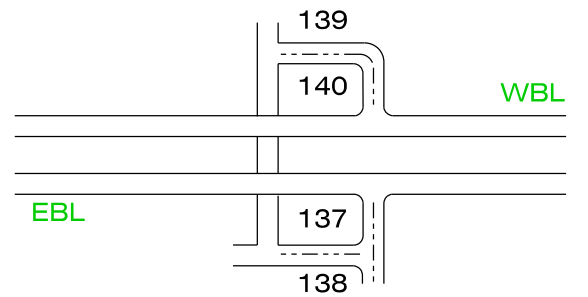

Black Butte Interchange
RM: 136.96 EXIT # 136

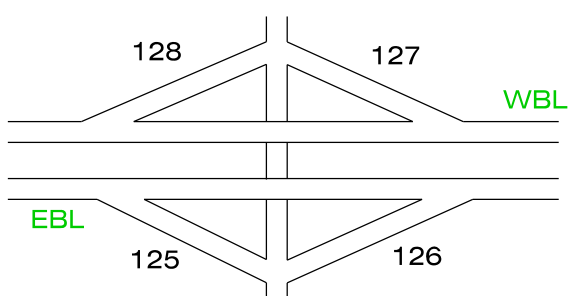
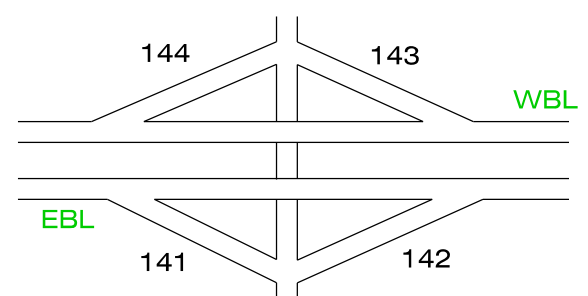

Table Rock Interchange
RM: 150.81 EXIT # 150



Bar X Interchange

RM: 152.46

EXIT # 152

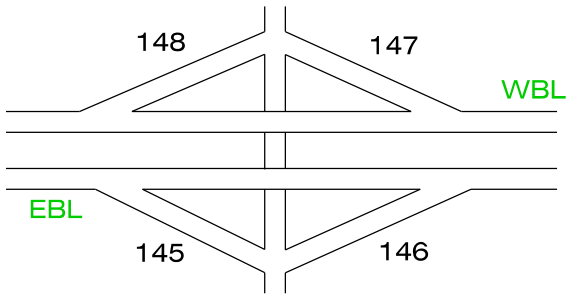

Red Desert Interchange

RM: 165.58

EXIT # 165

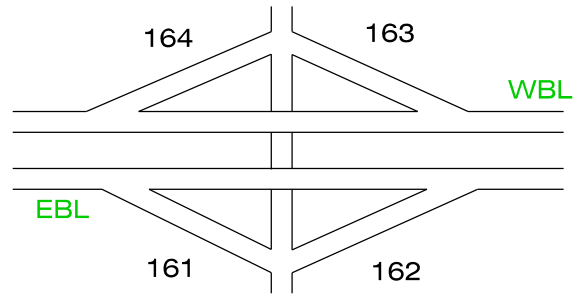

I-80 Interchange

154 BLM Road

Was removed

I-80 Interchanges

166 Booster Road

and

168 Frewen Road

Were removed fall of 2010

G. L. Road Interchange

RM: 156.03

EXIT # 156

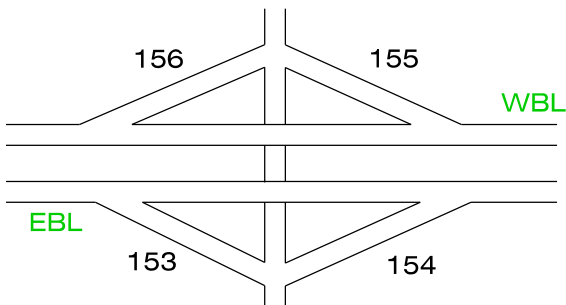

Tipton Interchange

RM: 158.55

EXIT # 158

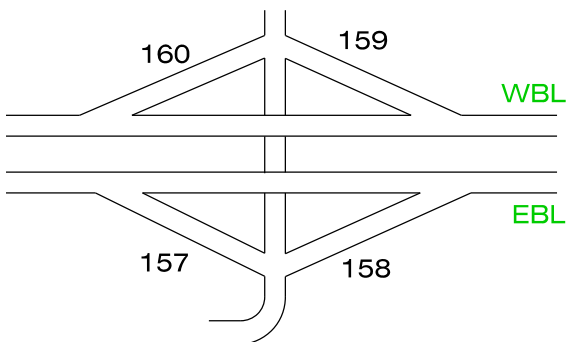

Rasmussen Road Interchange

RM: 170.68

EXIT # 170

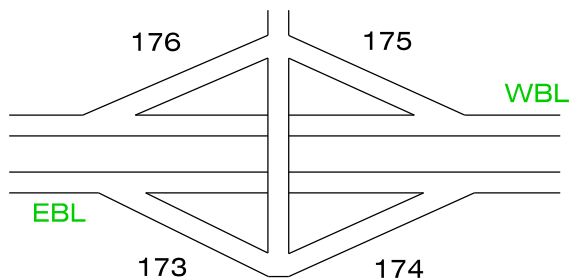

Wamsutter Interchange
RM: 173.41 EXIT # 173

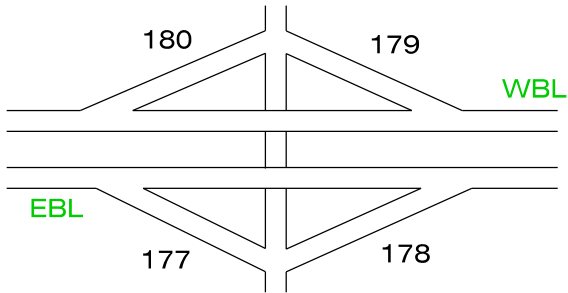

Daley Interchange
RM: 201.16 EXIT # 201

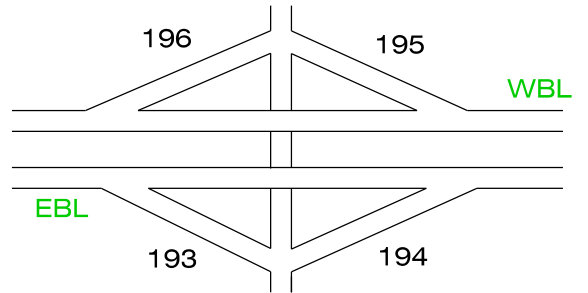

Continental Divide Interchange
RM: 184.29 EXIT # 184

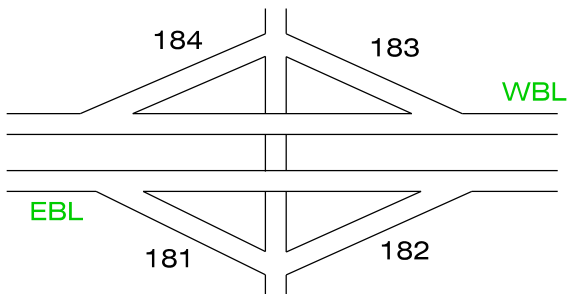

Knobbs Interchange
RM: 204.18 EXIT # 204

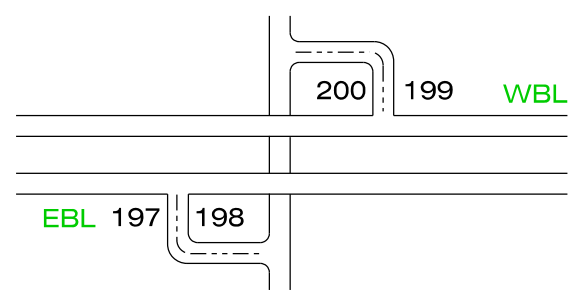

Wyo. 789 Interchange
RM: 187.20 EXIT # 187

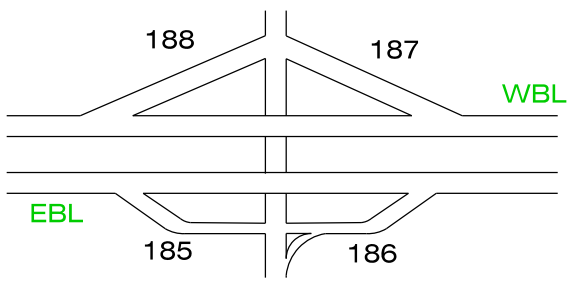

Hadsell Interchange
RM: 206.18 EXIT # 206

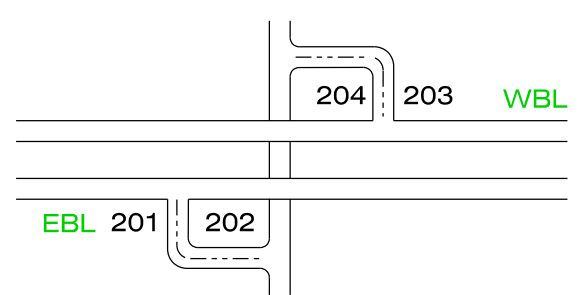

Riner Interchange
RM: 196.16 EXIT # 196

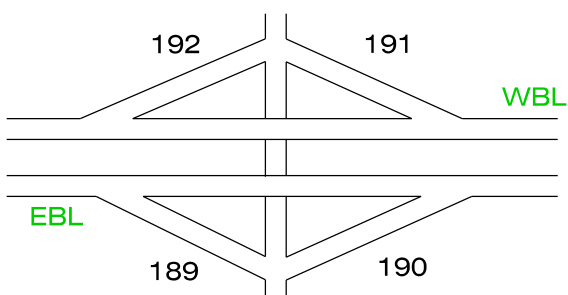

Johnson Road Interchange
RM: 209.46 EXIT # 209

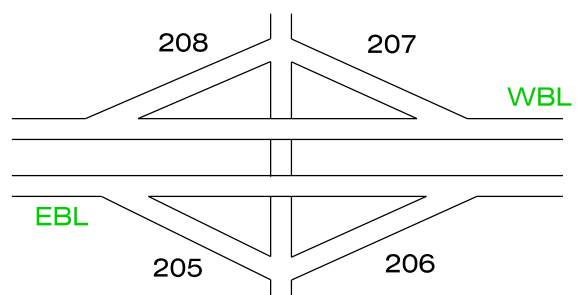

Spruce St. Interchange

RM: 211.78

EXIT # 211

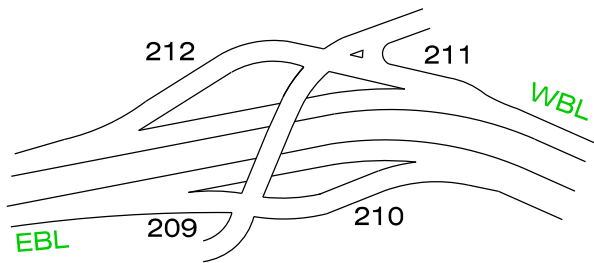

Higley Blvd Interchange

RM: 214.11

EXIT # 214

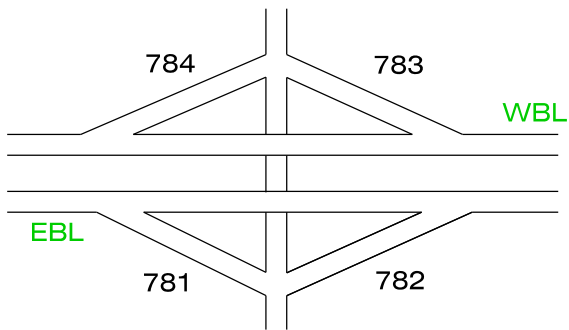

Cedar St. Interchange

RM: 215.57

EXIT # 215

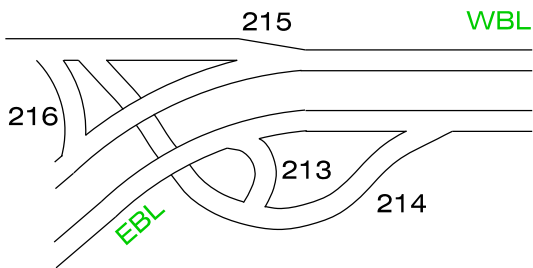

W. Sinclair Interchange

RM: 219.59

EXIT # 219

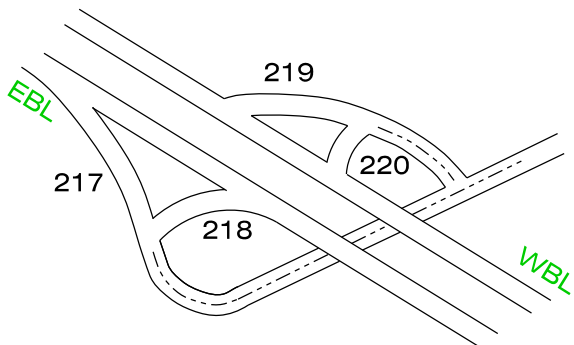

E. Sinclair Interchange

RM: 221.93

EXIT # 221

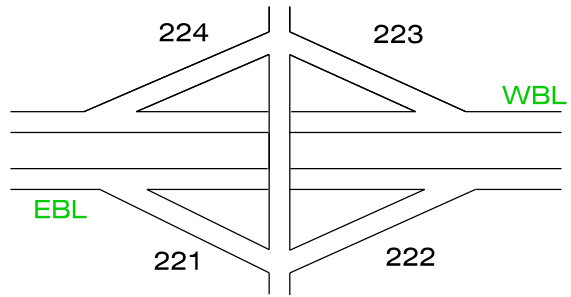

Fort Steele Interchange

RM: 228.34

EXIT # 228

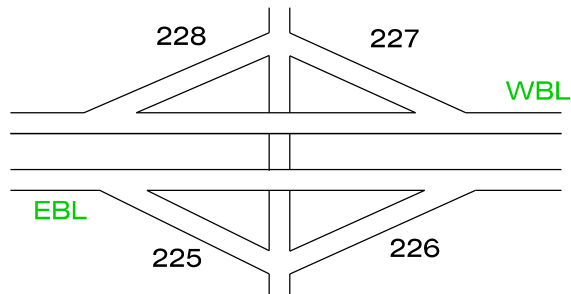

Saratoga Interchange

RM: 235.28

EXIT # 235

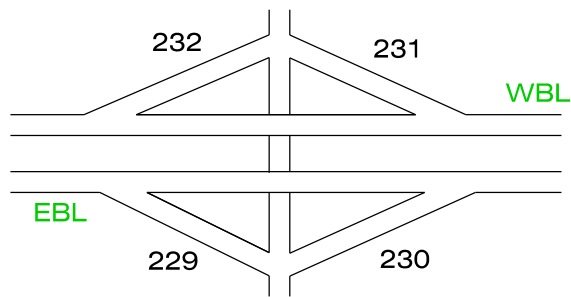

Peterson Interchange

RM: 238.15

EXIT # 238

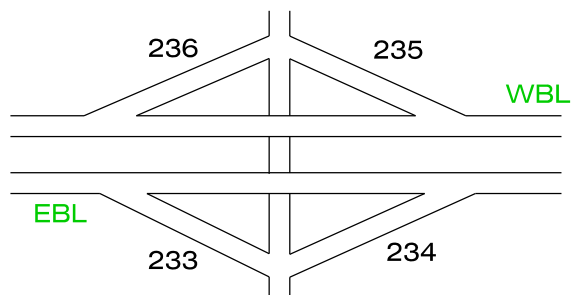

West Elk Mountain Interchange
 RM: 255.60 EXIT # 255

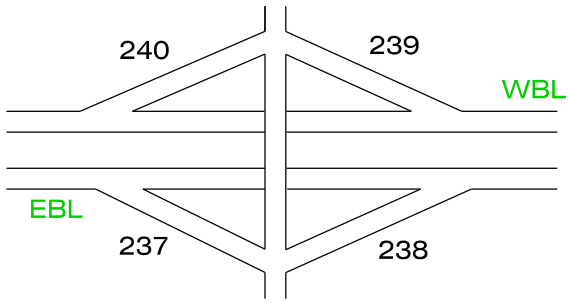

Cooper Cove Interchange
 RM: 279.86 EXIT # 279

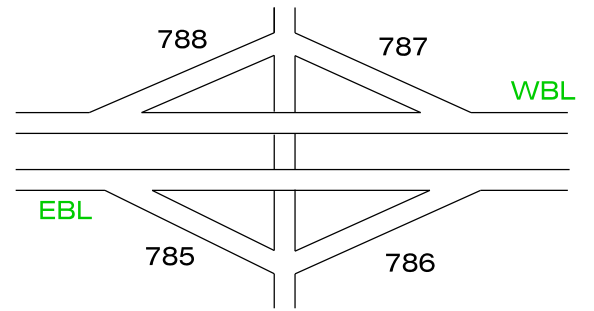

East Elk Mountain Interchange
 RM: 260.23 EXIT # 260

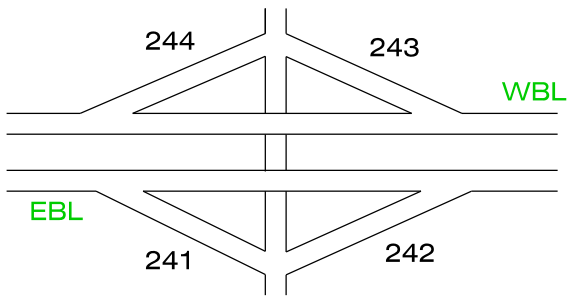

Quealy Dome Interchange
 RM: 290.44 EXIT # 290

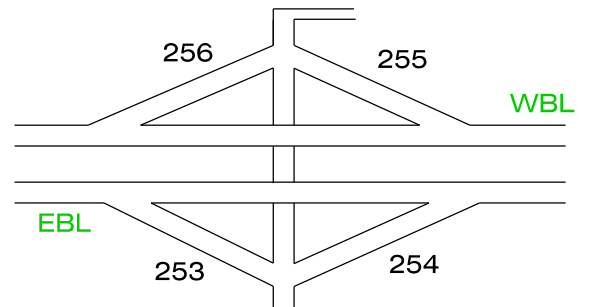

Wagonhound Interchange
 RM: 267.19 EXIT # 267

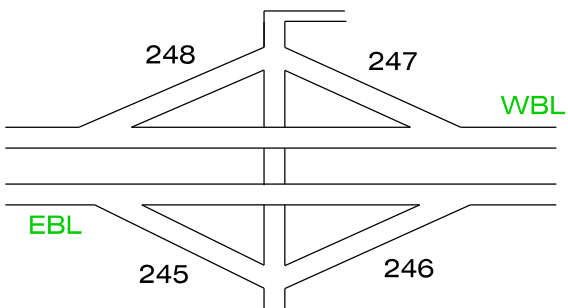

Herrick Lane Interchange
 RM: 297.66 EXIT # 297

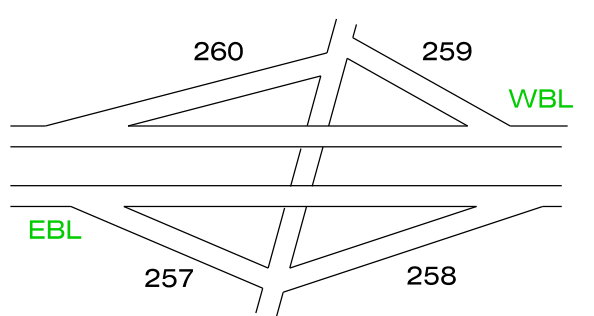

Arlington Interchange
 RM: 272.06 EXIT # 272

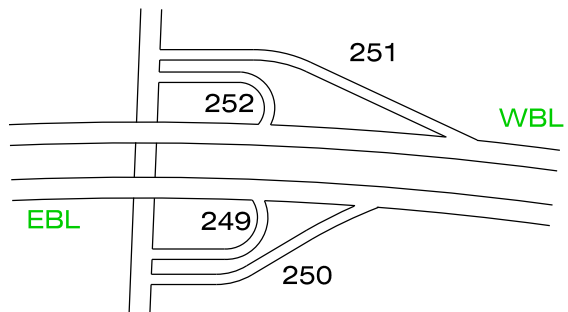

Curtis Street Interchange
 RM: 310.45 EXIT # 310

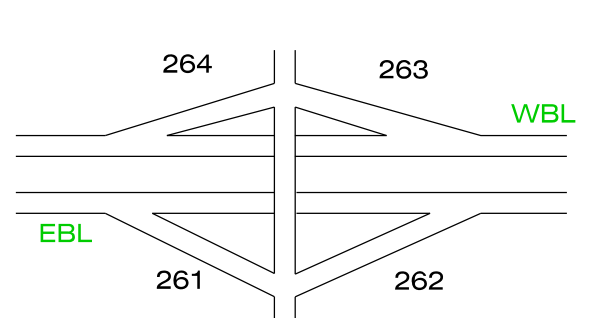

Snowy Range Rd. Interchange

RM: 311.76

EXIT # 311

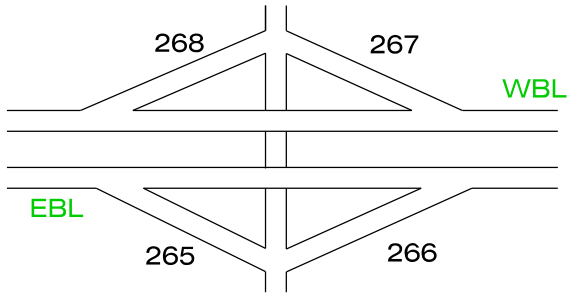

Vedauwoo Interchange

RM: 329.32

EXIT # 329

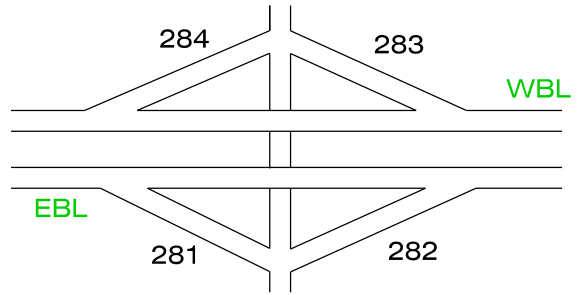

Third Street Interchange

RM: 313.19

EXIT # 313

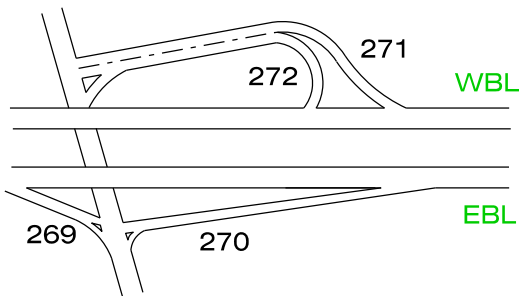

Buford Interchange

RM: 335.11

EXIT # 335

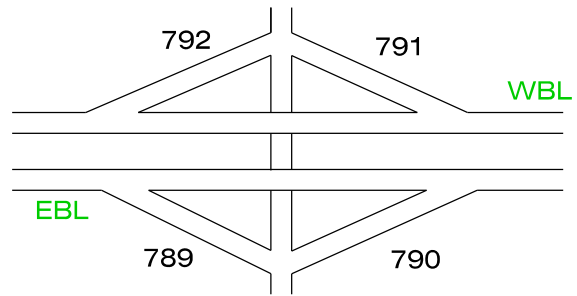

Grand Avenue Interchange

RM: 316.70

EXIT # 316

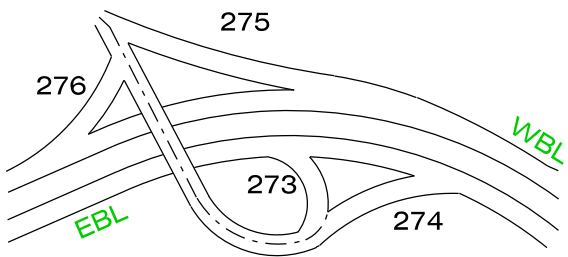

Remount Interchange

RM: 339.32

EXIT # 339

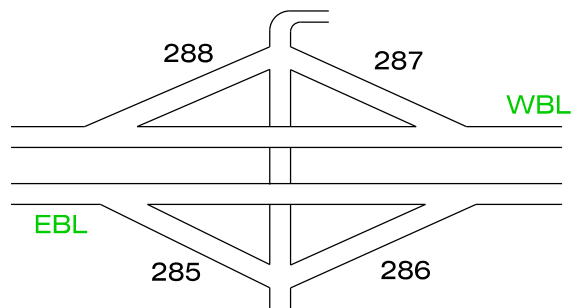

Happy Jack Summit Interchange

RM: 323.05

EXIT # 323

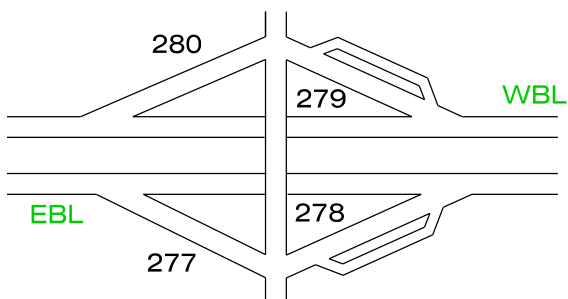

Harriman Interchange

RM: 342.56

EXIT # 342

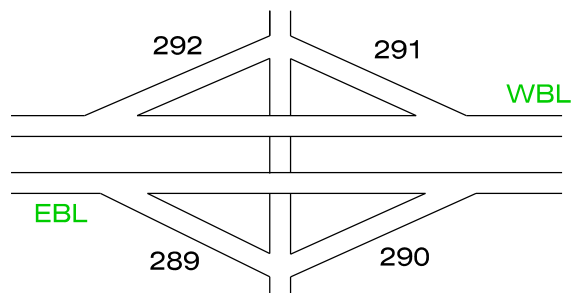

Warren Interchange

RM: 345.50

EXIT # 345

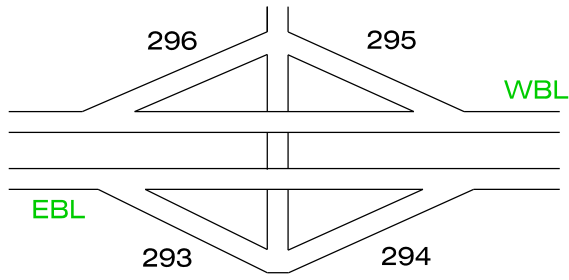

I-25 & I-80 Interchange

RM: 359.60

EXIT # 359 B

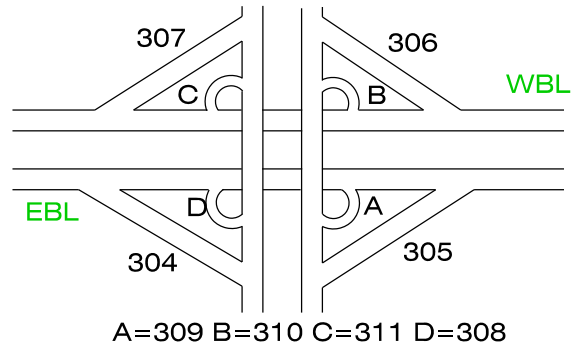

Otto Interchange

RM: 348.36

EXIT # 348

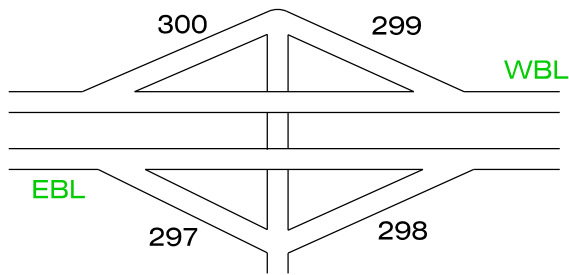

U.S. 85 Interchange

RM: 362.04

EXIT # 362

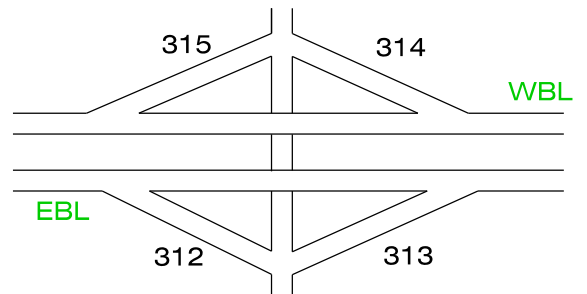

RoundTop Interchange

RM: 357.68

EXIT # 357

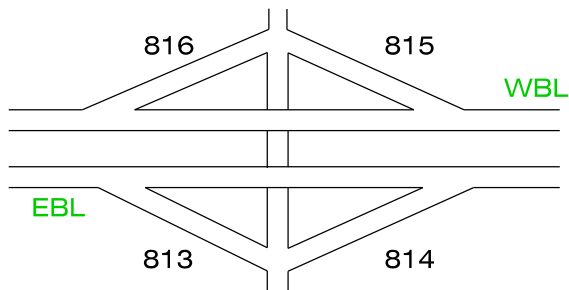

Sun Valley Interchange

RM: 364.00

EXIT # 364

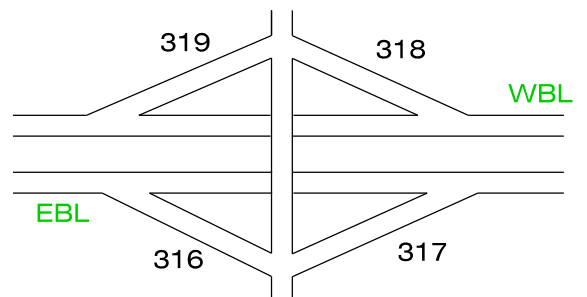

Lincolnway Interchange

RM: 359.08

EXIT # 359 A

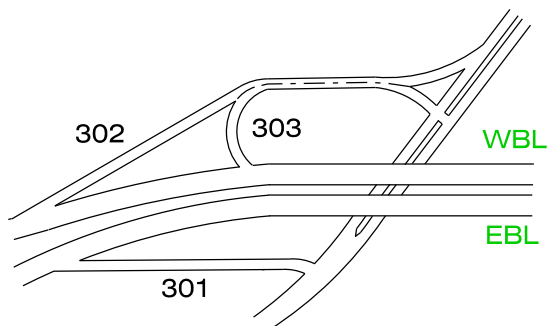

Campstool Road Interchange

RM: 367.42

EXIT # 367

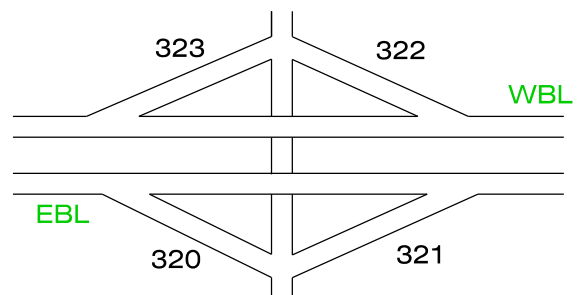

Archer Interchange
RM: 370.39

EXIT # 370

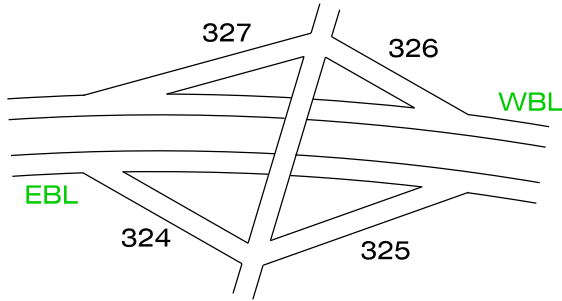

W. Pine Bluffs Interchange
RM: 401.46

EXIT # 401

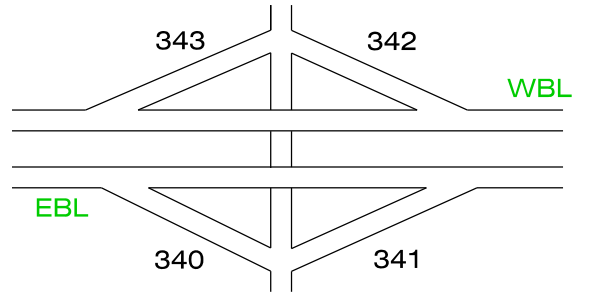

Hillsdale Interchange
RM: 377.35

EXIT # 377

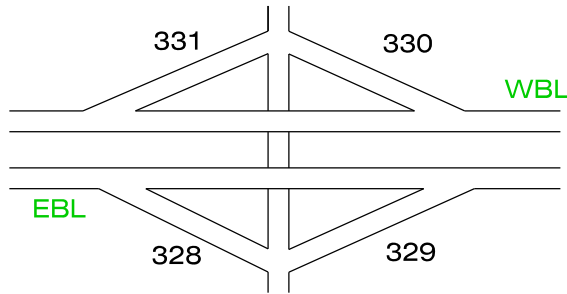

Burns- Carpenter Interchange
RM: 386.39

EXIT # 386

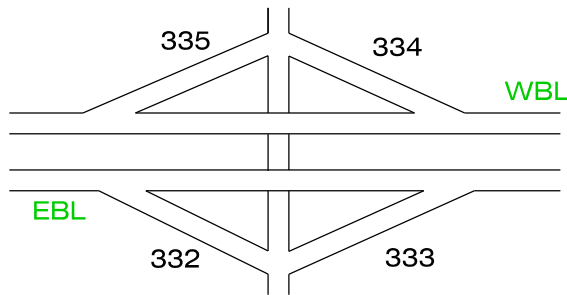

Egbert Interchange
RM: 391.39

EXIT # 391

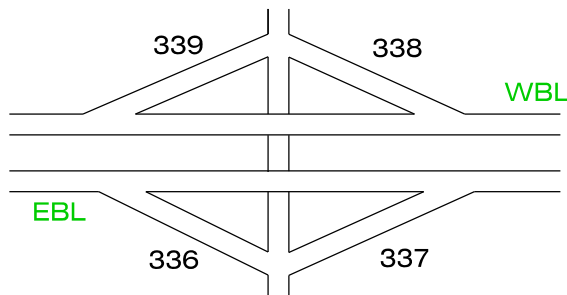

INTERCHANGE LAYOUTS

I - 90

Parkman Interchange

RM: 1.79

EXIT # 1

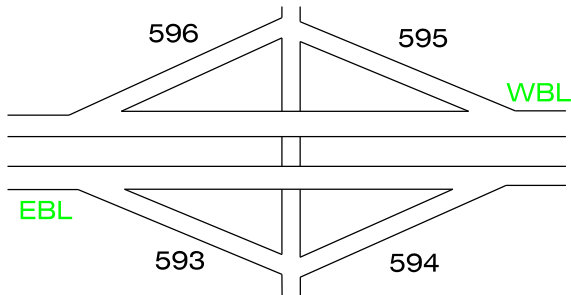

N. Sheridan Interchange

RM: 20.00

EXIT # 20

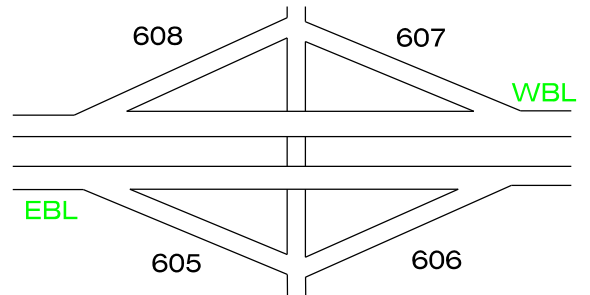

Ranchester Interchange

RM: 9.88

EXIT # 9

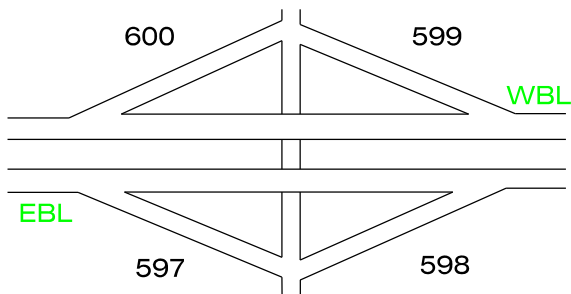

5th Street Interchange

RM: 23.15

EXIT # 23

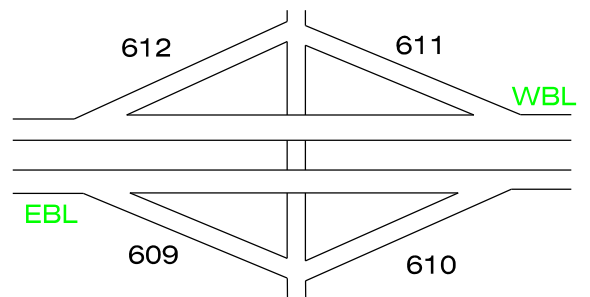

Acme Interchange

RM: 14.62

EXIT # 14

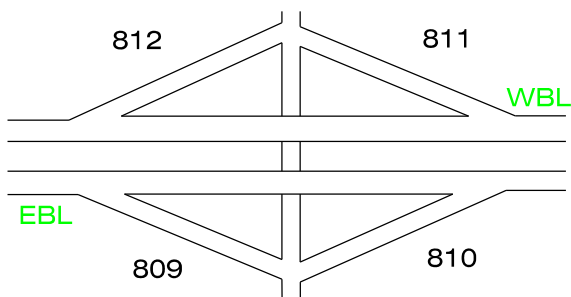

U.S. 14 Interchange

RM: 25.30

EXIT # 25

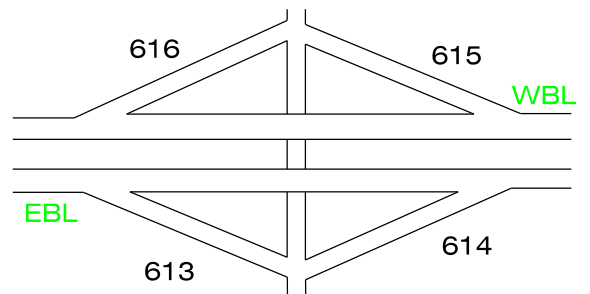

Dietz Interchange

RM: 16.34

EXIT # 16

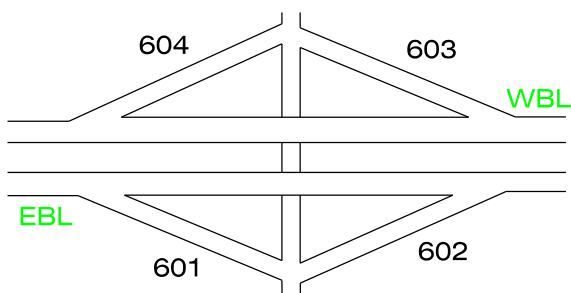

Meade Rd. Interchange

RM: 33.60

EXIT # 33

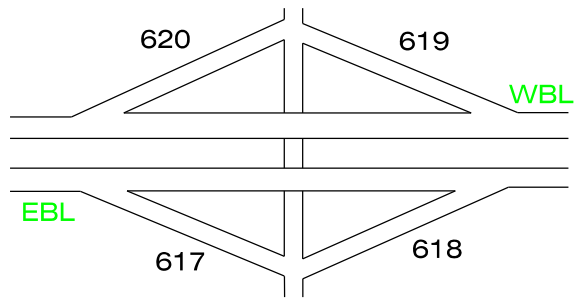

Lake DeSmet Interchange

RM: 51.36

EXIT # 51

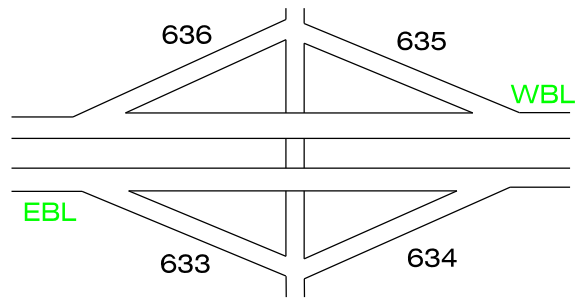

Prairie Dog Co. Rd. Interchange

RM: 37.16

EXIT # 37

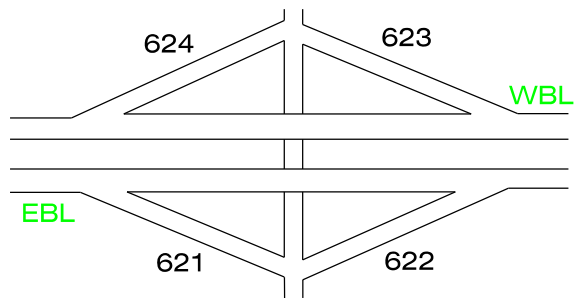

Rock Creek Rd. Interchange

RM: 53.83

EXIT # 53

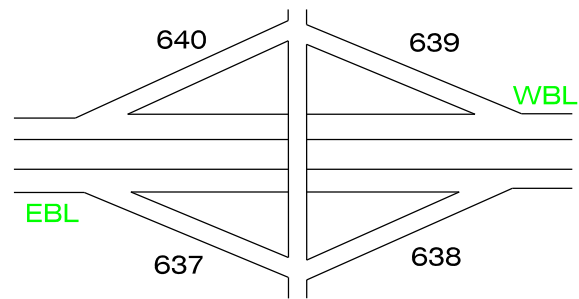

Piney Creek Interchange

RM: 44.69

EXIT # 44

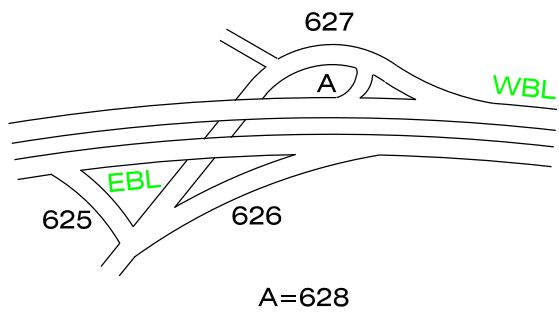

U.S. 87 N. Buffalo Interchange

RM: 56.36

EXIT # 56"A"

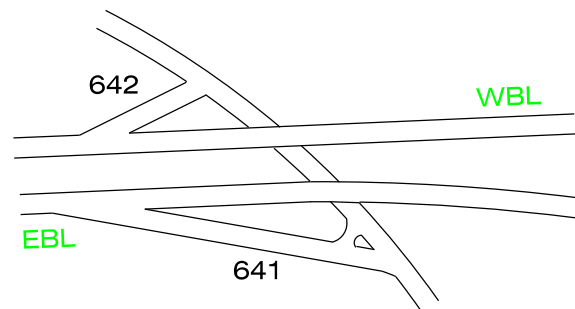

Shell Creek Interchange

RM: 47.71

EXIT # 47

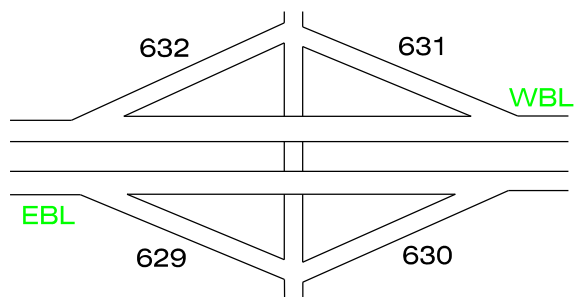

Buffalo Tri-Level Interchange

RM: 56.85

EXIT # 56"B" / 300

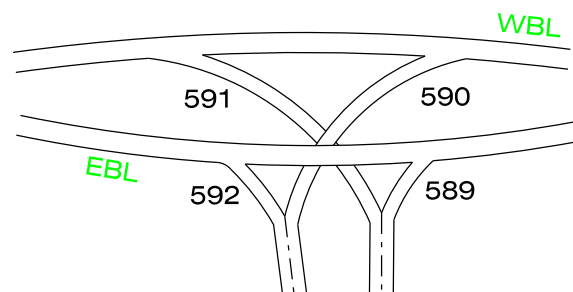

U.S. 16 Interchange

RM: 58.65

EXIT # 58

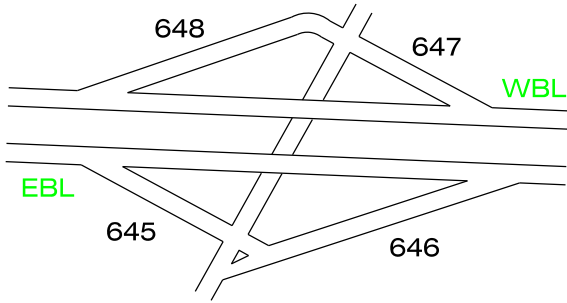

Schoonover Rd. Interchange

RM: 77.91

EXIT # 77

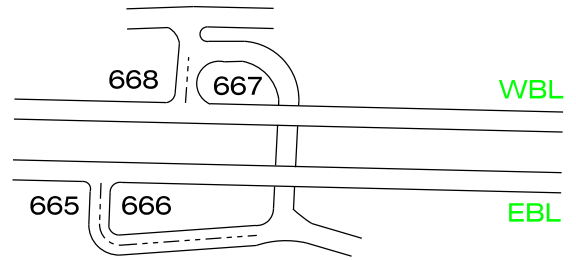

Red Hills Interchange

RM: 65.98

EXIT # 65

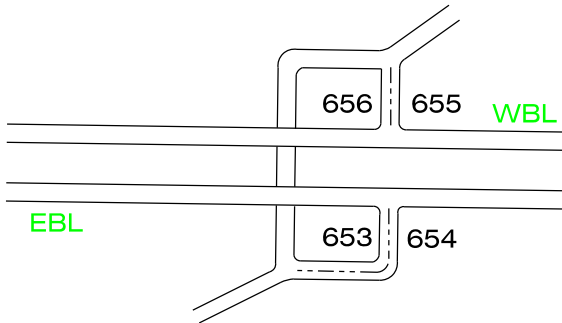

Indian Creek Interchange

RM: 82.83

EXIT # 82



Dry Creek Interchange

RM: 69.64

EXIT # 69

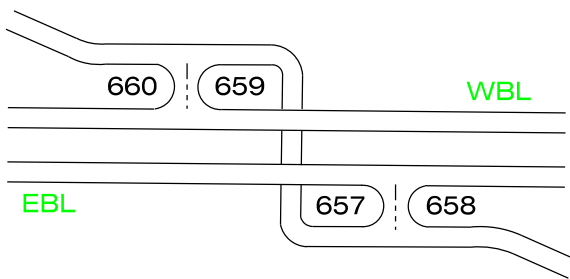

Powder River Interchange

RM: 88.67

EXIT # 88

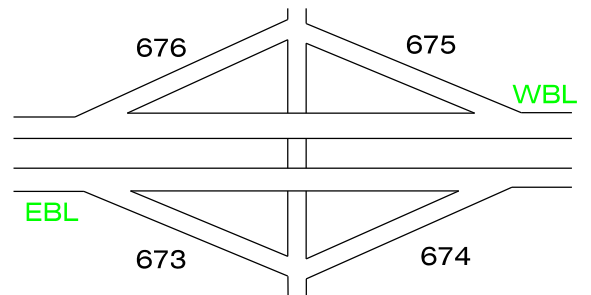

Crazy Woman Interchange

RM: 73.01

EXIT # 73

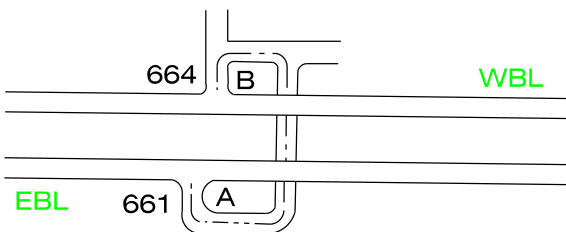

A=662 B=663

Dead Horse Interchange

RM: 91.49

EXIT # 91

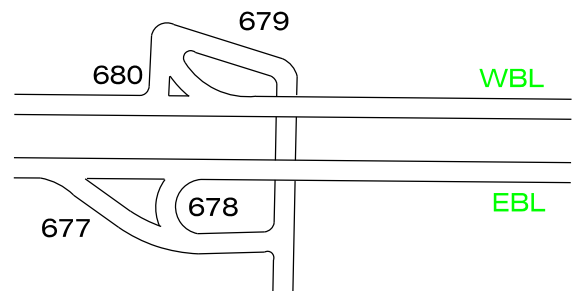

Barber Creek Interchange

RM: 102.52

EXIT # 102

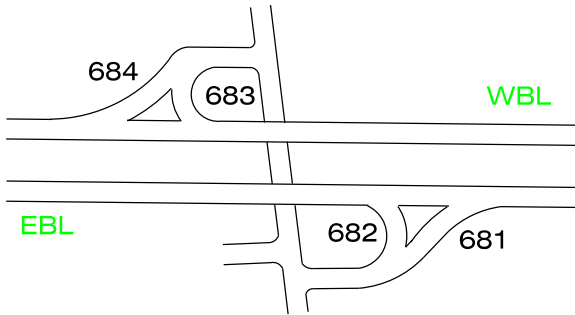

West Gillette Interchange

RM: 124.26

EXIT # 124

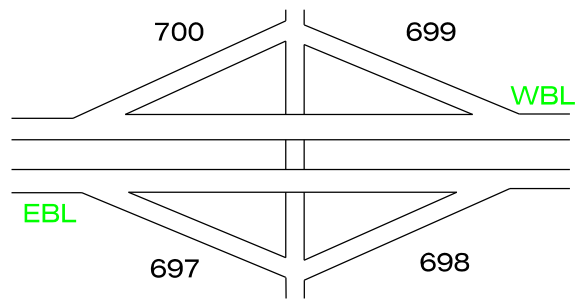

Kingsbury Rd. Interchange

RM: 106.14

EXIT # 106

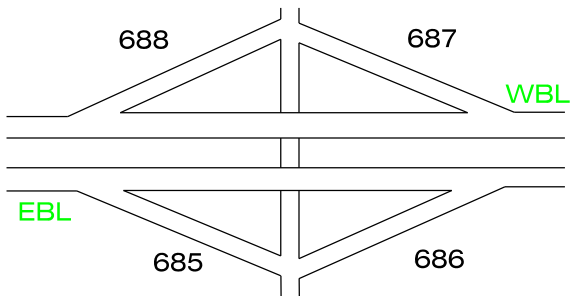

Wyo. 59 Interchange

RM: 126.39

EXIT # 126

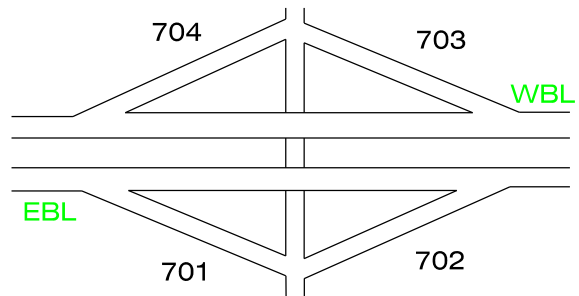

Wild Horse Creek Rd. Interchange

RM: 113.97

EXIT # 113

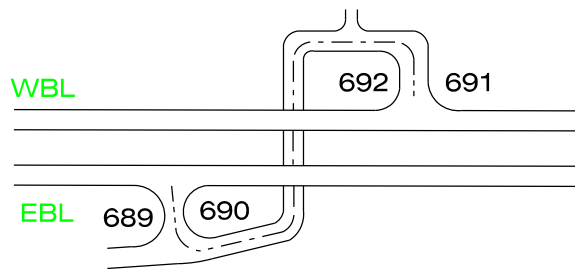

East Gillette Interchange

RM: 128.09

EXIT # 128

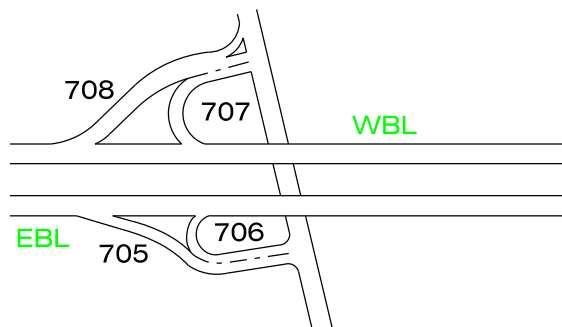

Force Rd. Interchange

RM: 116.24

EXIT # 116

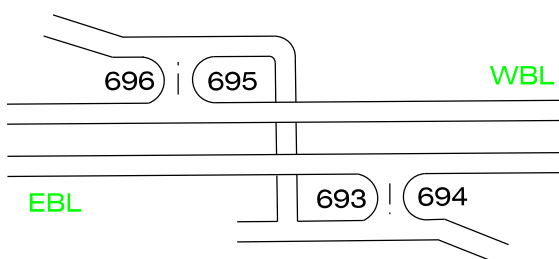

Garner Lake Rd. Interchange

RM: 129.10

EXIT # 129

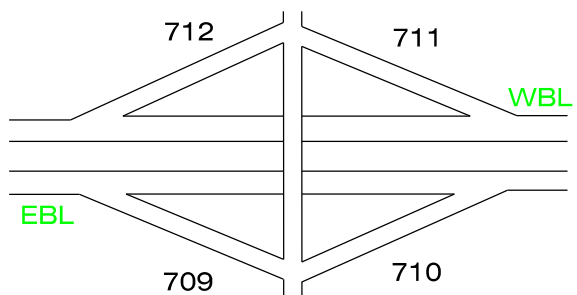

Wyodak Interchange

RM: 132.99

EXIT # 132

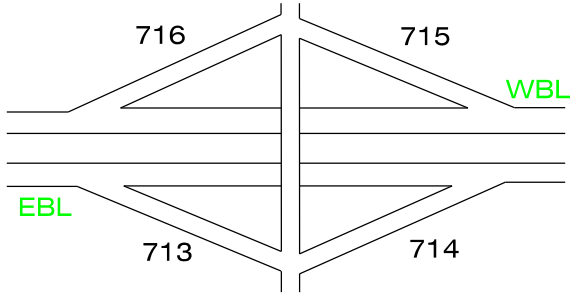

Wind Creek Interchange

RM: 160.66

EXIT # 160

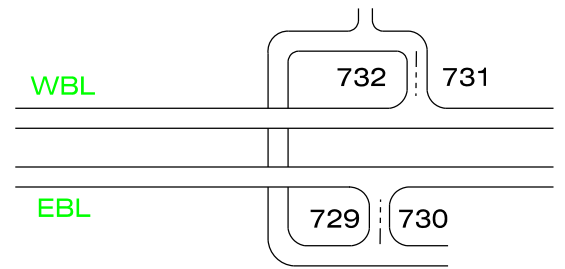

Rozet Interchange

RM: 141.24

EXIT # 141

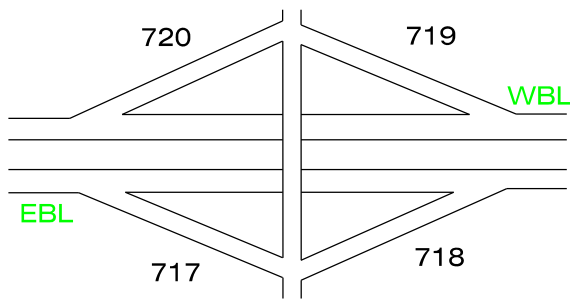

Pine Ridge Interchange

RM: 165.68

EXIT # 165

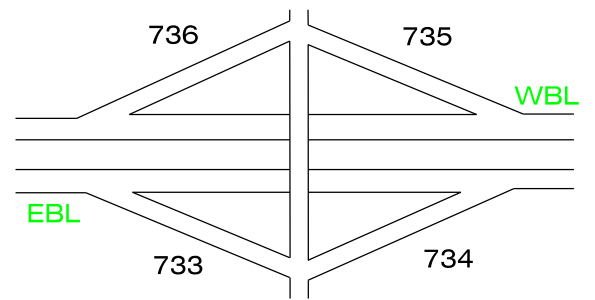

W. Moorcroft Interchange

RM: 153.41

EXIT # 153

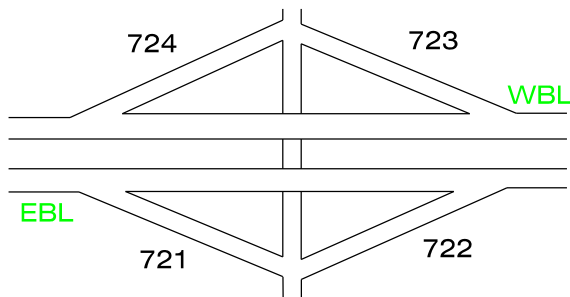

Inyan Kara Interchange

RM: 172.09

EXIT # 172

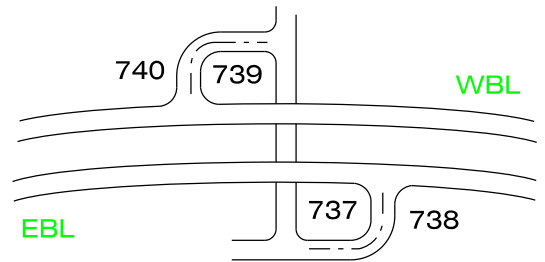

E. Moorcroft Interchange

RM: 154.69

EXIT # 154

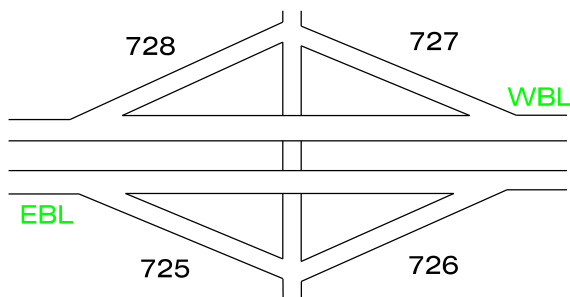

Coal Divide Interchange

RM: 178.92

EXIT # 178

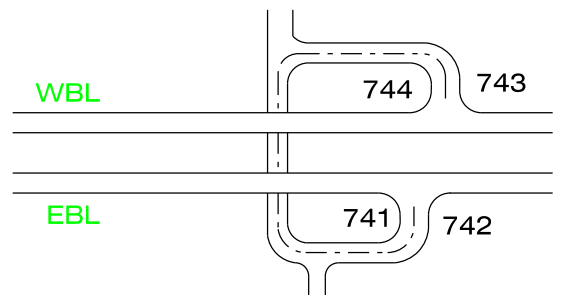

West Sundance Interchange

RM: 185.73

EXIT # 185

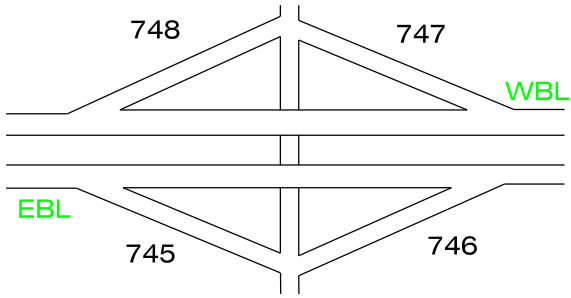

Moskee Interchange

RM: 191.92

EXIT # 191

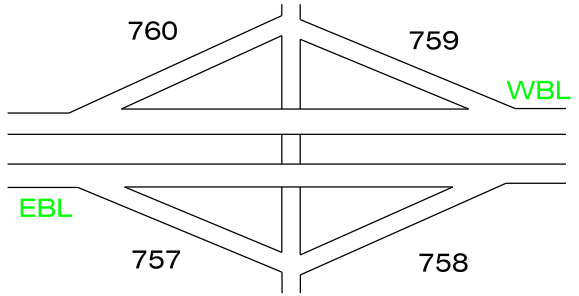

WYO 585 Interchange

RM: 187.53

EXIT # 187

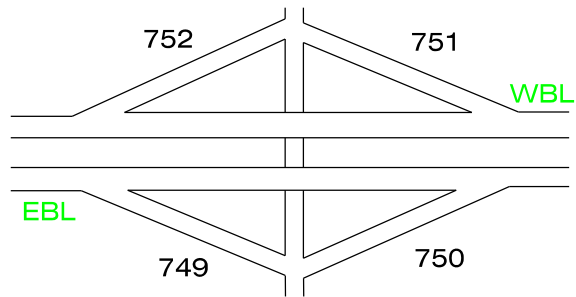

Aladdin Interchange

RM: 199.31

EXIT # 199

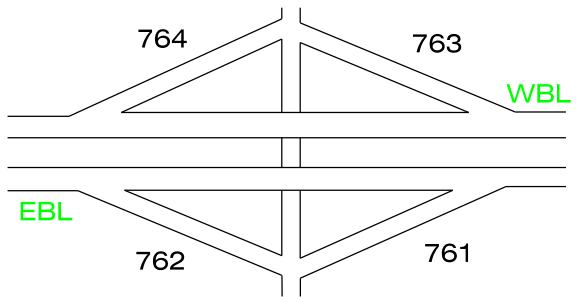

East Sundance Interchange

RM: 189.00

EXIT # 189

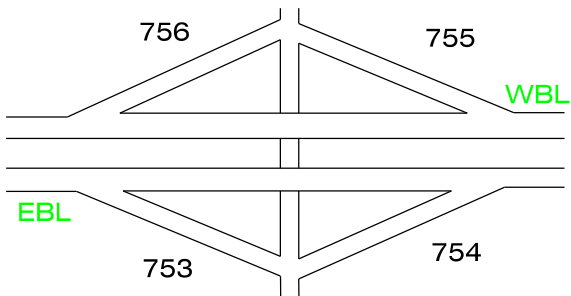

Beulah Interchange

RM: 205.90

EXIT # 205

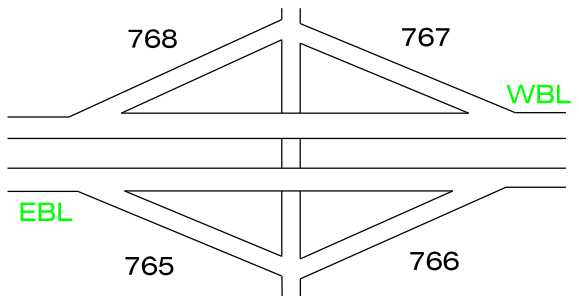

INTERCHANGE

LAYOUTS

OTHER

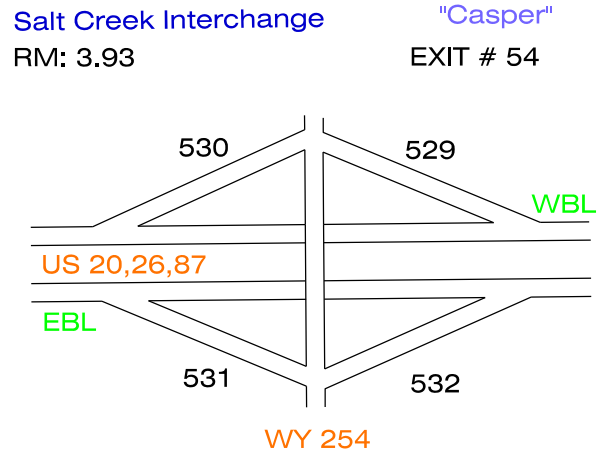
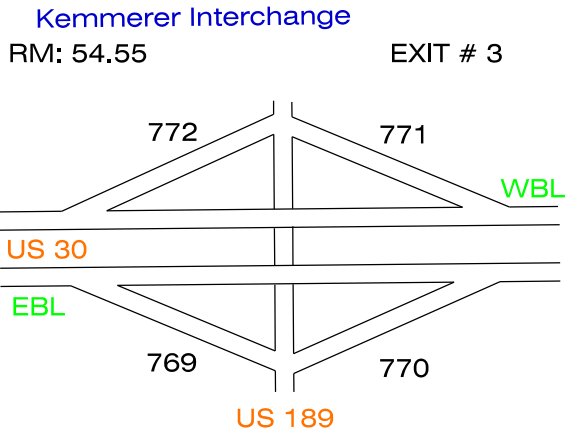

REFERENCE MARKER SYSTEM
 PLACEMENT AT SEPARATED
 ROADWAY LOCATIONS

Plate 2

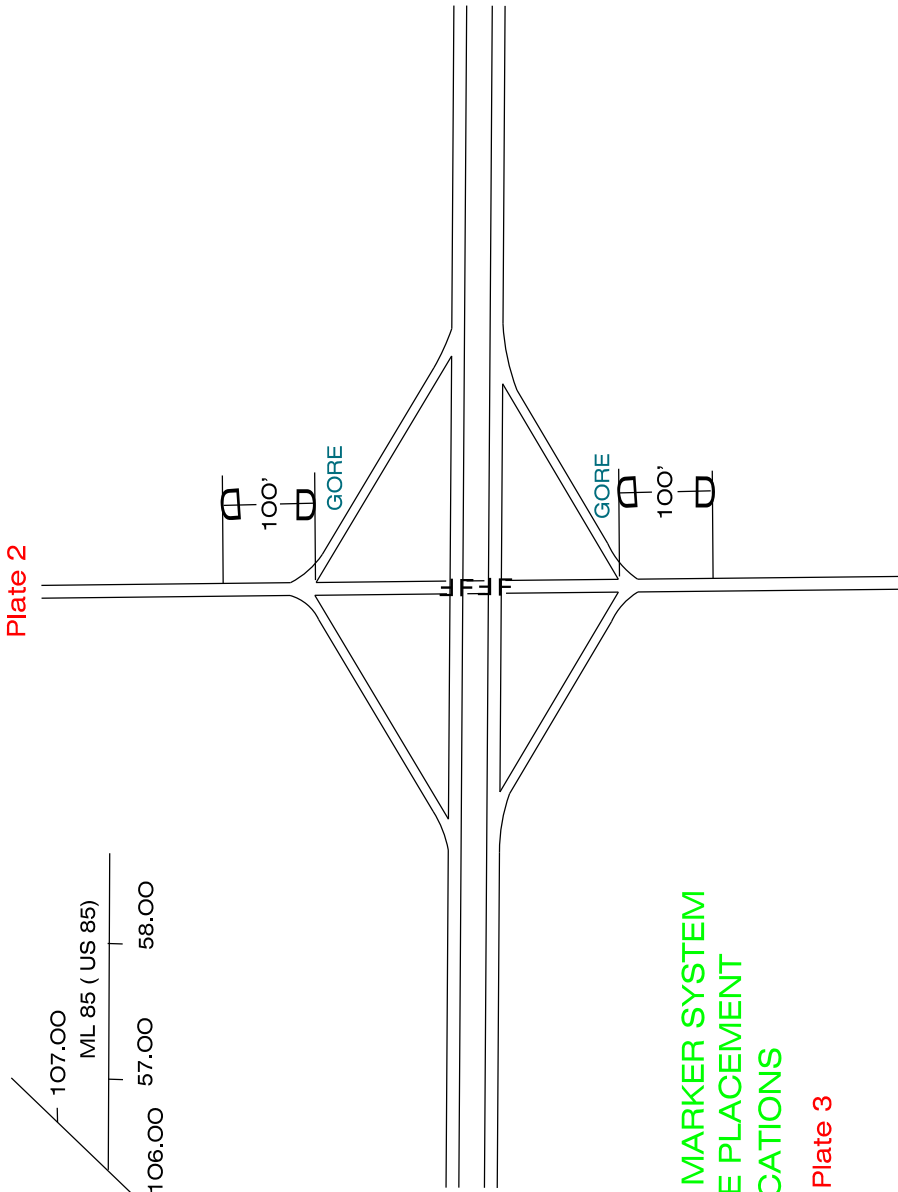

REFERENCE MARKER SYSTEM
 OVERLAPPING ROUTES

Plate 1

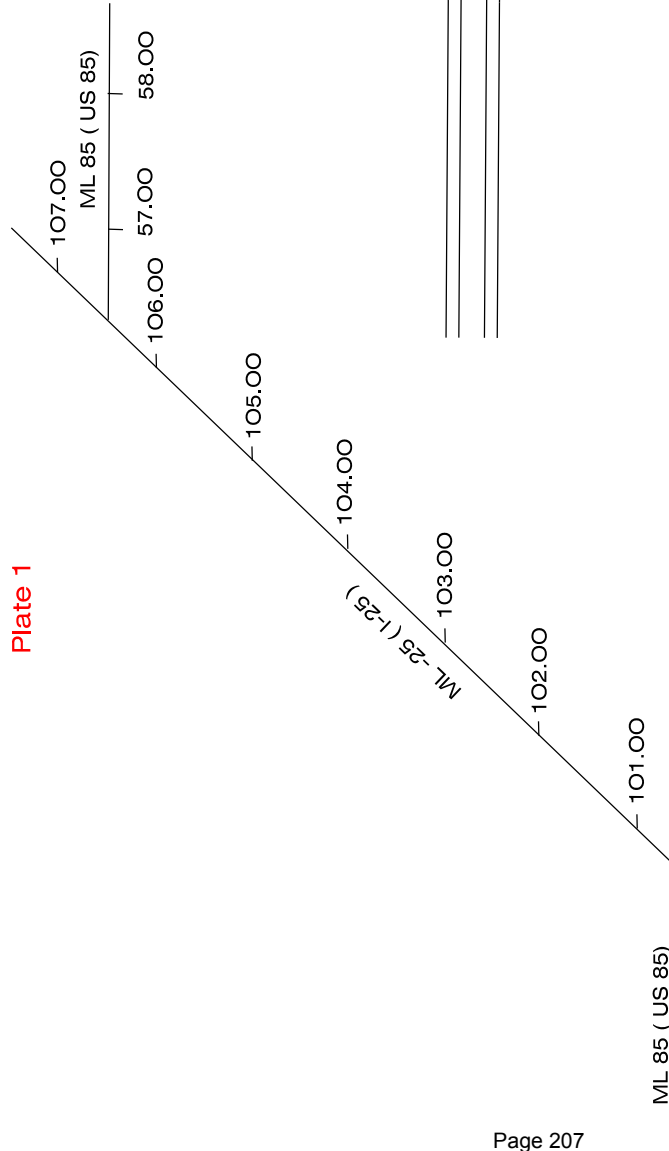

REFERENCE MARKER SYSTEM
 AT-GRADE PLACEMENT
 LOCATIONS

Plate 3

"T"
 INTERSECTION

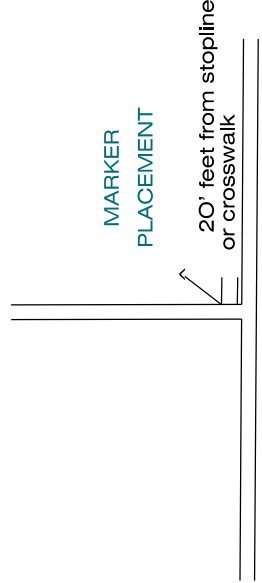

REFERENCE MARKER SYSTEM
 DISTANCE COMPUTATION POINTS
 AT INTERSECTIONS

Plate 4

AT GRADE INTERSECTIONS

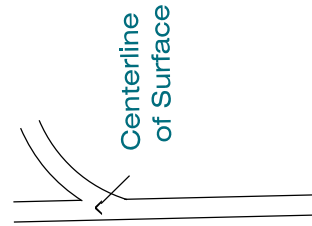
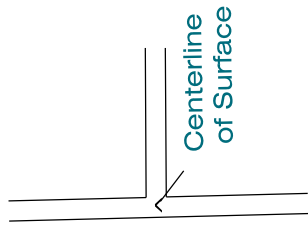

Distances are computed from the centerline of the surface for at grade intersections.

SEPARATED INTERSECTIONS

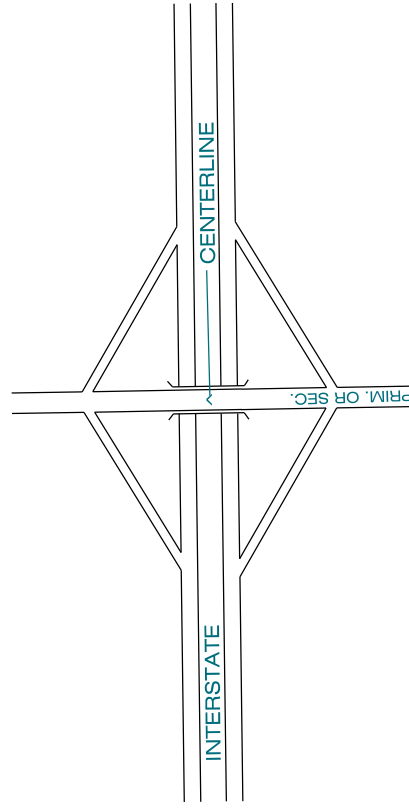
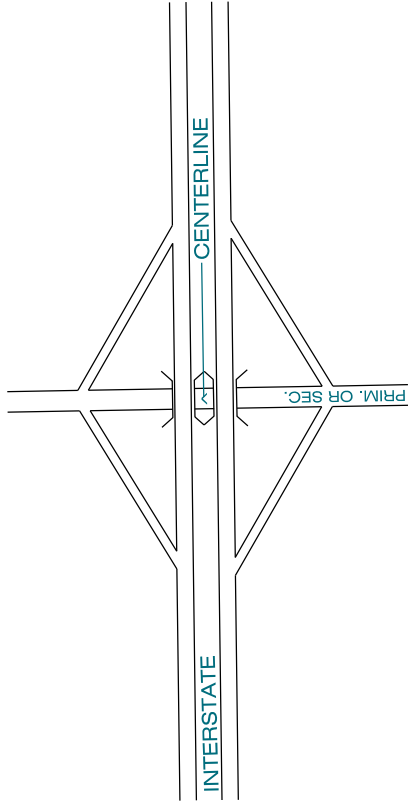

Distances are computed from the centerline for separated intersections.

REFERENCE MARKER SYSTEM
 TYPICAL TREATMENT FOR
 EQUATIONS

Plate 5

